

Upsampling DAC/Digital Pre-Amp

User's manual

2

ENGLISH

azur

851D

 **Cambridge Audio**
Your music + our passion

Contents

Important safety instructions	2
Limited warranty.....	4
Rear panel connections.....	5
Rear panel connections cont.	6
Front panel controls	6
Source connections	8
Operating instructions	10
Bluetooth	12
Filters	12
Custom installation (C.I.) use	14
Technical specifications.....	14
Troubleshooting.....	15

Make sure you register your purchase.

Visit: support.cambridgeaudio.com

By registering, you'll be the first to know about:

- Future product releases
- Software upgrades
- News, events and exclusive offers plus competitions!

This guide is designed to make installing and using this product as easy as possible. Information in this document has been carefully checked for accuracy at the time of printing; however, Cambridge Audio's policy is one of continuous improvement, therefore design and specifications are subject to change without prior notice.

This document contains proprietary information protected by copyright. All rights are reserved. No part of this manual may be reproduced by any mechanical, electronic or other means, in any form, without prior written permission of the manufacturer. All trademarks and registered trademarks are the property of their respective owners.

© Copyright Cambridge Audio Ltd 2013.

Cambridge Audio and the Cambridge Audio logo are trademarks of Cambridge Audio.

Other brands mentioned are trademarks of their respective owners and are used for reference purposes only.

Important safety instructions

For your own safety please read the following important safety instructions carefully before attempting to connect this unit to the mains power supply. They will also enable you to get the best performance from and prolong the life of the unit:

1. Read these instructions.
2. Keep these instructions.
3. Heed all warnings.
4. Follow all instructions.
5. Do not use this apparatus near water.
6. Clean only with a dry cloth.
7. Do not block any ventilation openings. Install in accordance with the manufacturer's instructions.
8. Do not install near any heat sources such as radiators, heat registers, stoves, or other apparatus (including other amplifiers) that produce heat.
9. Do not defeat the safety purpose of the polarized or grounding-type plug. A polarized plug has two blades with one wider than the other. A grounding-type plug has two blades and a third grounding prong. The wide blade or the third prong are provided for your safety. If the provided plug does not fit into your outlet, consult an electrician for replacement of the obsolete outlet.
10. Protect the power cord from being walked on or pinched, particularly at plugs, convenience receptacles and the point where they exit from the apparatus.
11. Only use attachments/accessories specified by the manufacturer.
12. Use with only the cart, stand, tripod, bracket, or table specified by the manufacturer, or sold with the apparatus. When a cart is used, use caution when moving the cart/ apparatus combination to avoid injury from tip-over. 
13. Unplug this apparatus during lightning storms or when unused for long periods of time.
14. Refer all servicing to qualified service personnel. Servicing is required when the apparatus has been damaged in any way, such as the power-supply cord or plug having been damaged, liquid has been spilled or objects have fallen into the apparatus, the apparatus has been exposed to rain or moisture, does not operate normally, or has been dropped.

WARNING

- To reduce the risk of fire or electric shock, do not expose this unit to rain or moisture.
- Batteries (battery pack or batteries installed) shall not be exposed to excessive heat such as sunshine, fire or the like.

The unit is of Class 1 construction and must be connected to a mains socket outlet with a protective earthing connection.

The unit must be installed in a manner that makes disconnection of the mains plug from the mains socket outlet (or appliance connector from the rear of the unit) possible. Where the mains plug is used as the disconnect device, the disconnect device shall remain readily operable. Only use the mains cord supplied with this unit.

Please ensure there is ample ventilation. We recommend that you do not place the unit in an enclosed space; if you wish to place the unit on a shelf, use the top shelf to allow maximum ventilation. Do not put any objects on top of this unit. Do not situate it on a rug or other soft surface and do not obstruct any air inlets or outlet grilles. Do not cover the ventilation grilles with items such as newspapers, tablecloths, curtains, etc.

This unit must not be used near water or exposed to dripping or splashing water or other liquids. No objects filled with liquid, such as vases, shall be placed on the unit.



The lightning flash with the arrowhead symbol within an equilateral triangle is intended to alert the user to the presence of un-insulated 'dangerous voltage' within the product's enclosure that may be of sufficient magnitude to constitute a risk of electric shock to persons.

The exclamation point within an equilateral triangle is intended to alert the user to the presence of important operating and maintenance instructions in the service literature relevant to this appliance.



WEEE symbol

The crossed-out wheeled bin is the European Union symbol for indicating separate collection for electrical and electronic equipment. This product contains electrical and electronic equipment which should be reused, recycled or recovered and should not be disposed of with unsorted regular waste.

Please return the unit or contact the authorised dealer from whom you purchased this product for more information.



CE mark

This product complies with European Low Voltage (2006/95/EC), Electromagnetic Compatibility (2004/108/EC) and Environmentally-friendly design of Energy-related Products (2009/125/EC) Directives when used and installed according to this instruction manual. For continued compliance only Cambridge Audio accessories should be used with this product and servicing must be referred to qualified service personnel.



C-Tick mark

This product meets the Australian Communications Authority's Radio communications and EMC requirements.



Gost-R Mark

This product meets Russian electronic safety approvals.

FCC regulations

NOTE: THE MANUFACTURER IS NOT RESPONSIBLE FOR ANY RADIO OR TV INTERFERENCE CAUSED BY UNAUTHORIZED MODIFICATIONS TO THIS EQUIPMENT. SUCH MODIFICATIONS COULD VOID THE USER AUTHORITY TO OPERATE THE EQUIPMENT.



This equipment has been tested and found to comply with the limits for a Class B digital device, pursuant to Part 15 of the FCC Rules. These limits are designed to provide reasonable protection against harmful interference in a residential installation. This equipment generates, uses and can radiate radio frequency energy and, if not installed and used in accordance with the instructions, may cause harmful interference to radio communications. However, there is no guarantee that interference will not occur in a particular installation.

If this equipment does cause harmful interference to radio or television reception, which can be determined by turning the equipment off and on, the user is encouraged to try to correct the interference by one or more of the following measures:

- Re-orient or relocate the receiving antenna.
- Increase the separation between the equipment and receiver.
- Connect the equipment into an outlet on a circuit different from that to which the receiver is connected.
- Consult the dealer or an experienced radio/TV technician for help.

Ventilation

IMPORTANT – The unit will become hot when in use. Do not stack multiple units on top of each other. Do not place in an enclosed area such as a bookcase or in a cabinet without sufficient ventilation.

Ensure that small objects do not fall through any ventilation grille. If this happens, switch off immediately, disconnect from the mains supply and contact your dealer for advice.

Positioning

Choose the installation location carefully. Avoid placing it in direct sunlight or close to a source of heat. No naked flame sources, such as lighted candles, should be placed on the unit. Also avoid locations subject to vibration and excessive dust, cold or moisture. The unit can be used in a moderate climate.

This unit must be installed on a sturdy, level surface. Do not place in a sealed area such as a bookcase or in a cabinet. Do not place the unit on an unstable surface or shelf. The unit may fall, causing serious injury to a child or adult as well as serious damage to the product. Do not place other equipment on top of the unit.

Due to stray magnetic fields, turntables or CRT TVs should not be located nearby due to possible interference.

Electronic audio components have a running in period of around a week (if used several hours per day). This will allow the new components to settle down and the sonic properties will improve over this time.

Power sources

The unit should be operated only from the type of power source indicated on the marking label. If you are not sure of the type of power-supply to your home, consult your product dealer or local power company.

This unit can be left in Standby mode when not in use and will draw <0.5W in this state. To turn the unit off, switch off at the rear panel. If you do not intend to use this unit for a long period of time, unplug it from the mains socket.

Overloading

Do not overload wall outlets or extension cords as this can result in a risk of fire or electric shock. Overloaded AC outlets, extension cords, frayed power cords, damaged or cracked wire insulation and broken plugs are dangerous. They may result in a shock or fire hazard.

Be sure to insert each power cord securely. To prevent hum and noise, do not bundle the interconnect leads with the power cord or speaker leads.

Cleaning

To clean the unit, wipe its case with a dry, lint-free cloth. Do not use any cleaning fluids containing alcohol, ammonia or abrasives. Do not spray an aerosol at or near the unit.

Battery disposal

Batteries may contain substances harmful to the environment. Please dispose of any discharged batteries with due consideration and in accordance with local environmental/electronic recycling guidelines.

Loudspeakers

Before making any connections to loudspeakers, make sure all power is turned off and only use suitable interconnects.

Servicing

These units are not user serviceable. Never attempt to repair, disassemble or reconstruct the unit if there seems to be a problem. A serious electric shock could result if this precautionary measure is ignored. In the event of a problem or failure, please contact your dealer.

Limited warranty

Cambridge Audio warrants this product to be free from defects in materials and workmanship (subject to the terms set forth below). Cambridge Audio will repair or replace (at Cambridge Audio's option) this product or any defective parts in this product. Warranty periods may vary from country to country. If in doubt consult your dealer and ensure that you retain proof of purchase.

To obtain warranty service, please contact the Cambridge Audio authorised dealer from which you purchased this product. If your dealer is not equipped to perform the repair of your Cambridge Audio product, it can be returned by your dealer to Cambridge Audio or an authorised Cambridge Audio service agent. You will need to ship this product in either its original packaging or packaging affording an equal degree of protection.

Proof of purchase in the form of a bill of sale or receipted invoice, which is evidence that this product is within the warranty period, must be presented to obtain warranty service.

This Warranty is invalid if (a) the factory-applied serial number has been altered or removed from this product or (b) this product was not purchased from a Cambridge Audio authorised dealer. You may call Cambridge Audio or your local country Cambridge Audio distributor to confirm that you have an unaltered serial number and/or you made a purchase from a Cambridge Audio authorised dealer.

This Warranty does not cover cosmetic damage or damage due to acts of God, accident, misuse, abuse, negligence, commercial use, or modification of, or to any part of, the product. This Warranty does not cover damage due to improper operation, maintenance or installation, or attempted repair by anyone other than Cambridge Audio or a Cambridge Audio dealer, or authorised service agent which is authorised to do Cambridge Audio warranty work. Any unauthorised repairs will void this Warranty. This Warranty does not cover products sold AS IS or WITH ALL FAULTS.

REPAIRS OR REPLACEMENTS AS PROVIDED UNDER THIS WARRANTY ARE THE EXCLUSIVE REMEDY OF THE CONSUMER. CAMBRIDGE AUDIO SHALL NOT BE LIABLE FOR ANY INCIDENTAL OR CONSEQUENTIAL DAMAGES FOR BREACH OF ANY EXPRESS OR IMPLIED WARRANTY IN THIS PRODUCT. EXCEPT TO THE EXTENT PROHIBITED BY LAW, THIS WARRANTY IS EXCLUSIVE AND IN LIEU OF ALL OTHER EXPRESS AND IMPLIED WARRANTIES WHATSOEVER INCLUDING, BUT NOT LIMITED TO, THE WARRANTY OF MERCHANTABILITY AND FITNESS FOR A PRACTICAL PURPOSE.

Some countries and US states do not allow the exclusion or limitation of incidental or consequential damages or implied warranties so the above exclusions may not apply to you. This Warranty gives you specific legal rights, and you may have other statutory rights, which vary from state to state or country to country.

For any service, in or out of warranty, please contact your dealer.

Plug Fitting Instructions (UK only)

The cord supplied with this appliance is factory-fitted with a UK mains plug fitted with a 3-amp fuse inside. If it is necessary to change the fuse, it is important that a 3-amp fuse is used. If the plug needs to be changed because it is not suitable for your socket, or becomes damaged, it should be cut off and an appropriate plug fitted following the wiring instructions below. The plug must then be disposed of safely, as insertion into a mains socket is likely to cause an electrical hazard. Should it be necessary to fit a 3-pin BS mains plug to the power cord, the wires should be fitted as shown in this diagram. The colours of the wires in the mains lead of this appliance may not correspond with the coloured markings identifying the terminals in your plug. Connect them as follows:

The wire which is coloured BLUE must be connected to the terminal which is marked with the letter 'N' or coloured BLACK.

The wire which is coloured BROWN must be connected to the terminal which is marked with the letter 'L' or coloured RED.

The wire which is coloured GREEN/YELLOW must be connected to the terminal which is marked with the letter 'E' or coloured GREEN.

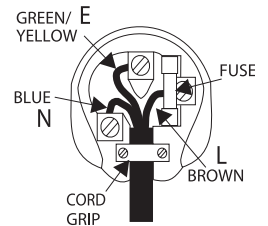

If a standard 13-amp (BS 1363) plug is used, a 3-amp fuse must be fitted or, if any other type of plug is used, a 3-amp fuse must be fitted, either in the plug or adaptor, or on the distribution board.

Rear panel connections

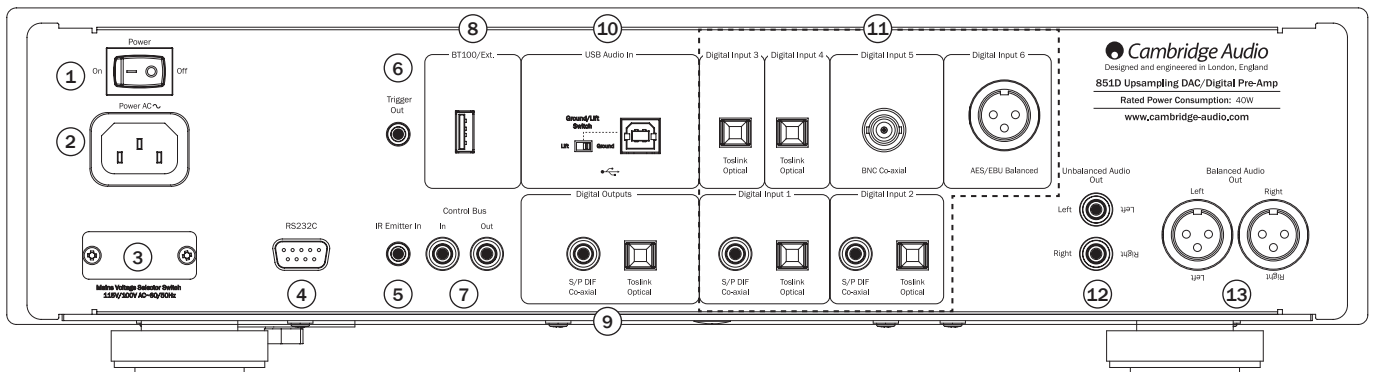

① Power On/Off

Switches the unit on and off.

This product has APD (Auto Power Down) enabled as default. After inactivity of 30 minutes, the product will automatically switch to Standby. See later section for further details.

② AC power socket

Once you have completed all connections to the DAC, plug the AC power cable into an appropriate mains socket then switch on. Your unit is now ready for use.

③ Mains Voltage Selector Switch (CU version only)

Switches the 851D mains voltage between 100V and 115V.

Note: Intended for use by a professional installer or Cambridge Audio retailer only.

④ RS232C

The RS232C port allows external serial control of the 851D for custom install use. A full command set is available on the Cambridge Audio website at www.cambridge-audio.com. This port can also be used by Cambridge Audio service personnel for software updates.

⑤ IR (Infrared) Emitter In

Allows modulated IR commands from multi-room systems to be received by the amplifier. Commands received here are not looped out of the Control Bus. Refer to the 'Custom installation' section for more information.

⑥ Trigger Out

This 12V trigger output can be used to control external devices such as an 851W or another power amplifier, or a subwoofer, projector, screen etc. See later section for further details.

⑦ Control Bus

In - Allows un-modulated commands from multi-rooms systems or other components to be received by the unit.

Out - Loop out for control bus commands to another unit. Also allows the 851D to control some Cambridge Audio units.

⑧ BT100/Ext.

The optional Cambridge Audio BT100 Bluetooth Adaptor can be plugged in here adding wireless streaming audio capability directly from most phones, tablets and laptops. Will also be use for planned optional future wireless modules. Can also be use for charging devices up to 500mA. See later section for details.

⑨ Digital Outputs

The 851D digital outputs allow connection to a separate DAC (digital to analogue converter) or can be used to loop the selected signal through to an AVR.

Note: These outputs pass through the currently selected audio source un-processed, i.e. no volume control or up-sampling is performed on the digital outputs.

Coaxial - To obtain best results, use a high quality 75 ohm digital RCA interconnect cable (not one designed for normal audio use).

Toslink Optical - Use a high quality TOSLINK fibre optic interconnect cable designed specifically for audio use.

⑩ USB Interface

A USB B type socket is fitted to the 851D to enable the playback of audio from a personal computer running either Microsoft Windows or Apple Mac OS X operating systems. Some builds of Linux are also suitable.

Note: Always use a high quality USB connection cable certified as USB Hi-Speed. USB cable connections longer than 3m may result in inconsistent audio performance.



Always turn the Volume to minimum, switch to another input or turn the 851D off before plugging/unplugging cables to the USB input or whilst booting up/shutting down your PC/Mac.

Ground Lift Switch

The Ground Lift Switch enables the USB interface earth to be disconnected from the 851D chassis earth. Disconnecting (lifting) the earth can be useful if electronic hum is heard through the speakers when the USB input is selected. The switch should otherwise be left in the Ground position.

⑪ Digital Inputs 1 - 6

The 851D has 6 digital inputs in total. Inputs 1 and 2 feature both S/PDIF co-axial and Toslink optical sockets. You can use whichever is most convenient, but not both at the same time. Inputs 3 and 4 feature Toslink optical sockets only. Input 5 features BNC co-axial socket and input 6 features a AES/EBU Balanced socket.

Coaxial - Use a high quality 75 ohm digital RCA Phono interconnect cable (not one designed for normal audio use). This input is suitable for 16-24 bit content up to 192kHz.

Toslink Optical - Use a high quality TOSLINK fibre optic interconnect cable designed specifically for audio use. This input is suitable for 16-24 bit content up to 96kHz (Toslink is not recommended at 192kHz sampling rates).

BNC Coaxial - Use a high quality 75 ohm digital RCA Phono interconnect cable (not one designed for normal audio use). This input is suitable for 16-24 bit content up to 192kHz. If required, a BNC to RCA coaxial adaptor or a BNC to RCA coaxial cable can be used to provide connectivity to a third S/PDIF coaxial digital input source

AES/EBU - For sources with a balanced (AES/EBU) digital output. This input is suitable for 16-24 bit content up to 192kHz.

Rear panel connections cont.

12 Unbalanced Audio Output

A conventional RCA phono stereo output for connection to the line-level inputs of an amplifier. Use a high quality stereo RCA phono interconnect cable intended for analogue audio signals.

13 Balanced Audio Output

The 851D features balanced outputs on two XLR sockets. Balanced outputs provide slightly better audio performance and can reject cable-borne noise and interference when used with equipment with balanced inputs.

Note: XLR connectors should be wired as follows:

- Pin 1:** Ground
- Pin 2:** Hot (in-phase)
- Pin 3:** Cold (phase-inverted)

Front panel controls

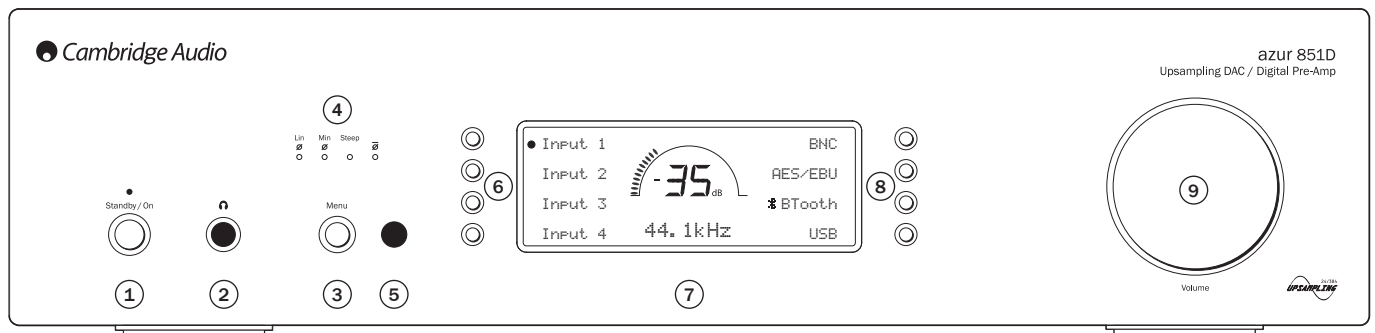

1 Standby/On

Switches the unit between Standby mode (indicated by dim power LED) and On (indicated by bright power LED). Standby is a low power mode where the power consumption is less than 0.5 Watts. The unit can be left in Standby mode when not in use.

2 Headphone connection

Allows for the connection of headphones with a 1/4" jack plug connector.

Note: 600 Ohm headphones will work well on the 851D. However, with some less sensitive models maximum volume maybe limited. If louder listening is required, a lower impedance / higher sensitivity set of headphones is recommended.

3 Menu

Press to enter the 851D's setup menus. Various 851D operating parameters can be configured. Refer to the 'Operating instructions' section for more information.

4 Filter

The different digital filters can be selected from the 851D's setup menu. Alternatively, pressing the Filter/∅ button on the remote will cycle through different digital filter phase modes: Linear, Minimum, Steep, Linear inverted, Minimum inverted and Steep inverted. Alternative digital filters can offer subtly different sound quality characteristics. See later section for further details. The currently selected filter is displayed by the indicators just above the button.

Phase

Press the Filter button on the remote to cycle through different phase output.

If you suspect that your source material or amplifier, etc., is inverting the phase of the musical signal, you can use this function to re-invert the audio and regain absolute positive phase by pressing the phase button in the setup menu. Alternatively, to select using the remote control, cycle through the modes as described above.

5 Infrared sensor

Receives IR commands from the supplied Azur remote control. A clear unobstructed line of sight between the remote control and the sensor is required.

6 & 8 Source select buttons

Push the appropriate input selection button to select the source component that you wish to listen to (highlighted by a solid circle on the display).

7 Display

LCD used to control the 851D. Please refer to the 'Operating instructions' and 'Settings' section of this manual for more information.

9 Volume

When Pre-amp mode is enabled, use to increase/decrease the level of the sound from the outputs of the pre-amplifier. This control affects the level of the analogue audio output, and the headphones output. It does not affect the digital output connections

Please refer to the 'Operating instructions' section of this manual for more information on some of the functions of these buttons.

Remote control

The 851D is supplied with a Cambridge Audio System remote control that operates both this upsampling DAC/digital pre-amp and Cambridge Audio 851 series and Stream Magic products. Insert the supplied AAA batteries to activate.

The functions relevant to the 851D are as follows:

1. Standby/On

Switches the 851D between On and Standby mode.

2. Mute

Mutes the audio on the pre-amplifier. The mute mode is indicated by MUTE appearing and the volume level being replaced by two flashing dashes in the display. Press again to cancel mute.

3. Bright

Adjust the backlight of the front panel display; bright, dim or off.

4. Headphone volume

Increase or decrease the volume of the headphone output.

5. Home

Press to return to main menu.

6. Volume

Increase or decrease the volume of the pre-amplifier output.

7. Back

Press to go back to the previous menu item.

8. Navigation buttons

Press to navigate around the main menus.

9. Illuminate button

Press to illuminate the buttons on the remote.

10. Source buttons

D1-D6: Press the corresponding source button to select the digital source inputs.

 **Bluetooth (BT100):** Press to select bluetooth source input using the BT100 dongle. To pair devices, press and hold for a few seconds to initiate the pairing function.

Note: Disconnect one device before pairing another, or turn the Bluetooth function off from the currently connected device before pairing another.

 **USB (PC):** Press to select the USB audio source input.

See later sections for more details.

11. Trigger

Press to override the current trigger output state, for example to turn a power amplifier or projector on or off.

12. Filter/Ø

Press to cycle through different digital filter phase modes: Linear, Minimum, Steep, Linear inverted, Minimum inverted and Steep inverted. The corresponding LED will light up to show which filter has been selected. These affect the analogue outputs only. See later section for more details.

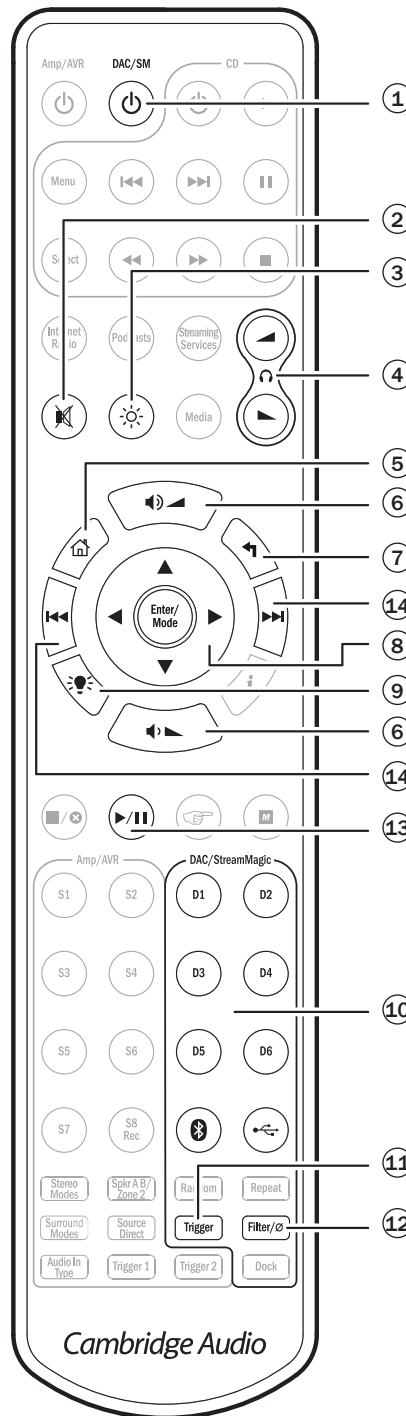

The following functions are available via USB and Bluetooth playback.

Note: These functions will depend on the audio software installed on the host personal computer or paired devices.

13. Play / Pause

Press the relevant button to play or pause a track.

14. Skip

Right Skip () – Press once to skip forward by one track on the playlist.

Left Skip () – Press once to skip backward by one track on the playlist.

Source connections

Important: Do not turn on any of the units until all connections have been made.

When designing our products we include features that allow you to connect your system in various ways. The inclusion of these features means that you can flexibly configure your system depending on your requirements.

Unbalanced audio connection

The diagram below shows a Stream Magic 6 being connected to Digital Input 1 of the 851D, which is in turn connected to the 851A via the Unbalanced output.

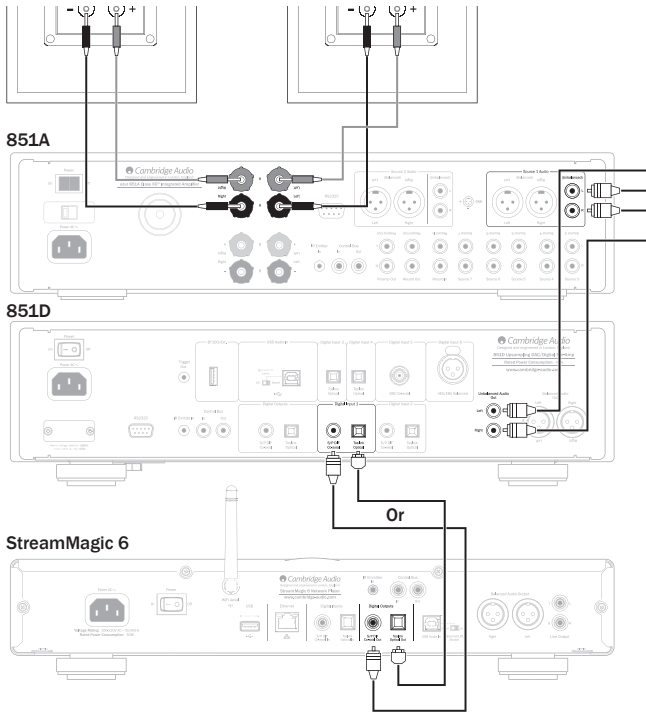

Balanced audio connection

The diagram below shows a Stream Magic 6 being connected to Digital Input 1 of the 851D, which is in turn connected to the 851A via the Balanced output.

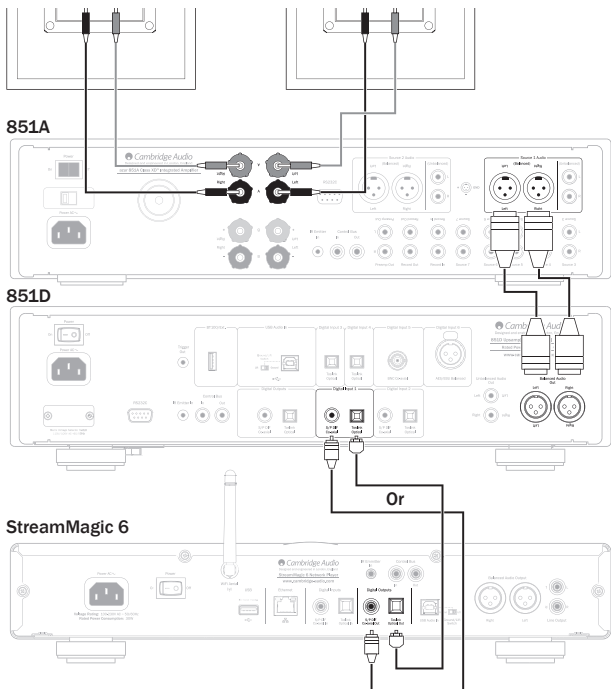

PC-USB connection

The diagram below shows the USB audio input connection from a personal computer using a type A-B USB lead to your 851D and an 851A amplifier using Source 1 (Balanced).

Note: Unbalanced connection can also be used, if preferred.

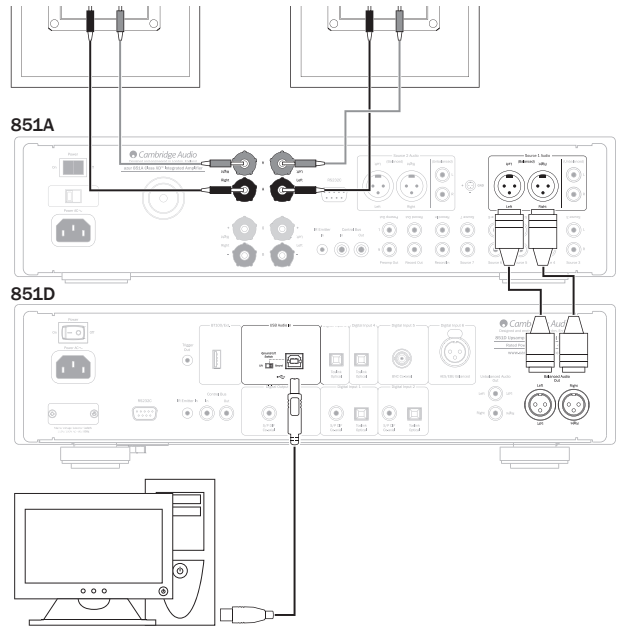

PC/Mac

Note: Always use a certified cable for USB Audio, preferably one that displays an official USB Audio 2.0 logo. The cable should be the 'Hi-Speed USB' certified. USB cable connections longer than 3m may result in inconsistent audio performance.

Bluetooth audio connection

The diagram below shows the bluetooth audio input connection of your paired device to your 851D using the BT100 bluetooth dongle and a 851A amplifier using Source 1 (Balanced).

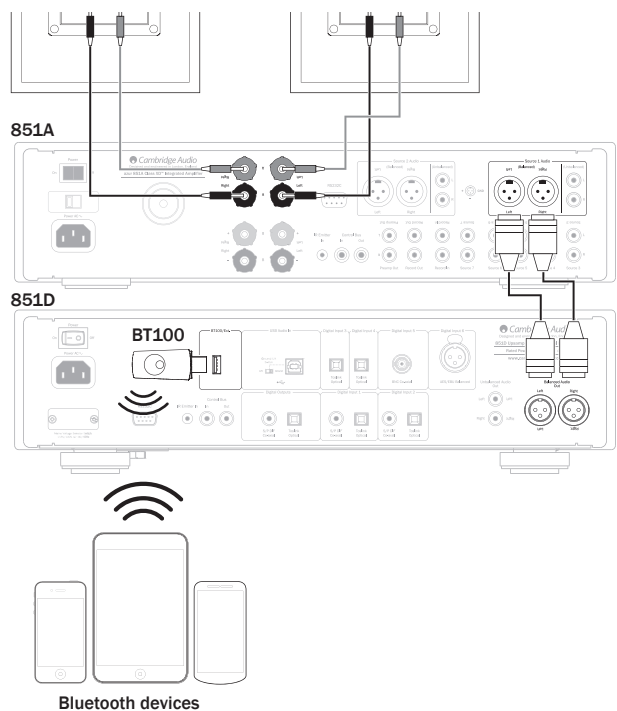

For more information on BT100, please contact your dealer.

Pre-Amp mode connection with power syncing

The diagrams below shows the 851D in Pre-Amp mode, connected to an 851W power amplifier through the Balanced Audio Out and also with power syncing connection, through Control Bus or Trigger Out. See later section of the manual.

Note: When connecting to an 851W, Unbalanced connection can also be used, if preferred.

Control Bus connection

Control Bus is the recommended method when using the 851D and other Cambridge Audio equipment with Control Bus In/Out.

Trigger connection

Trigger Out can be useful if the 851D is desired to control other equipment that features trigger connections (Custom install and/or Multi-Room Systems etc).

Control Bus connection

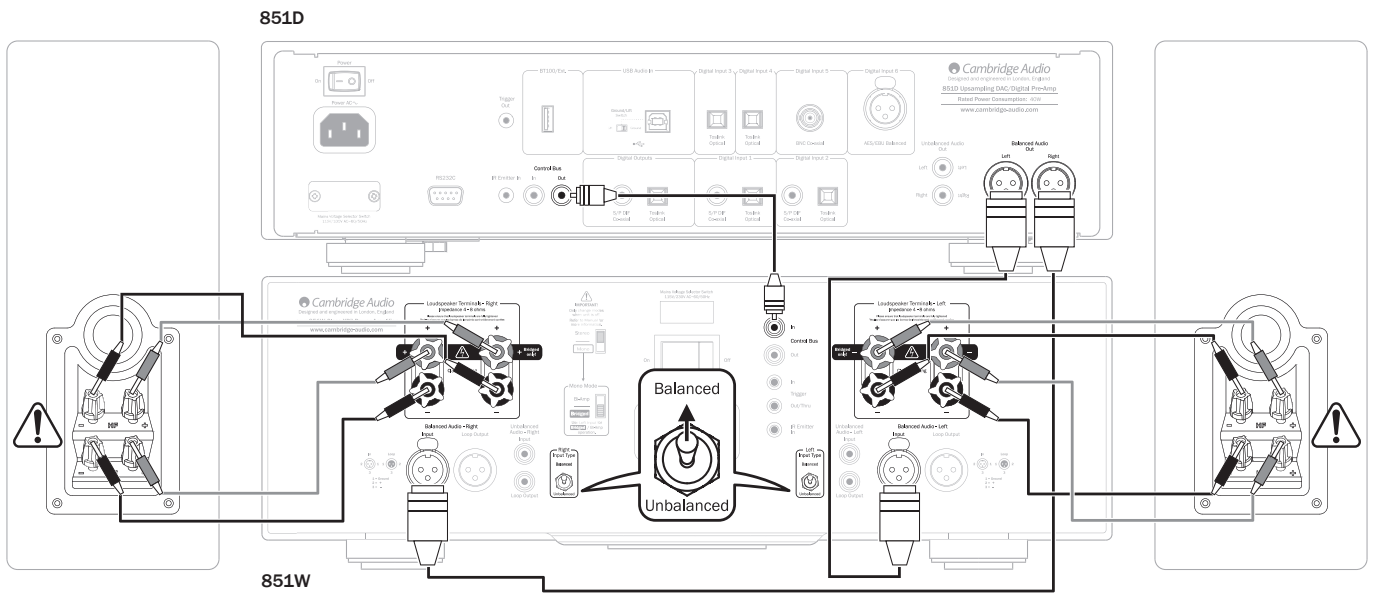

Trigger connection

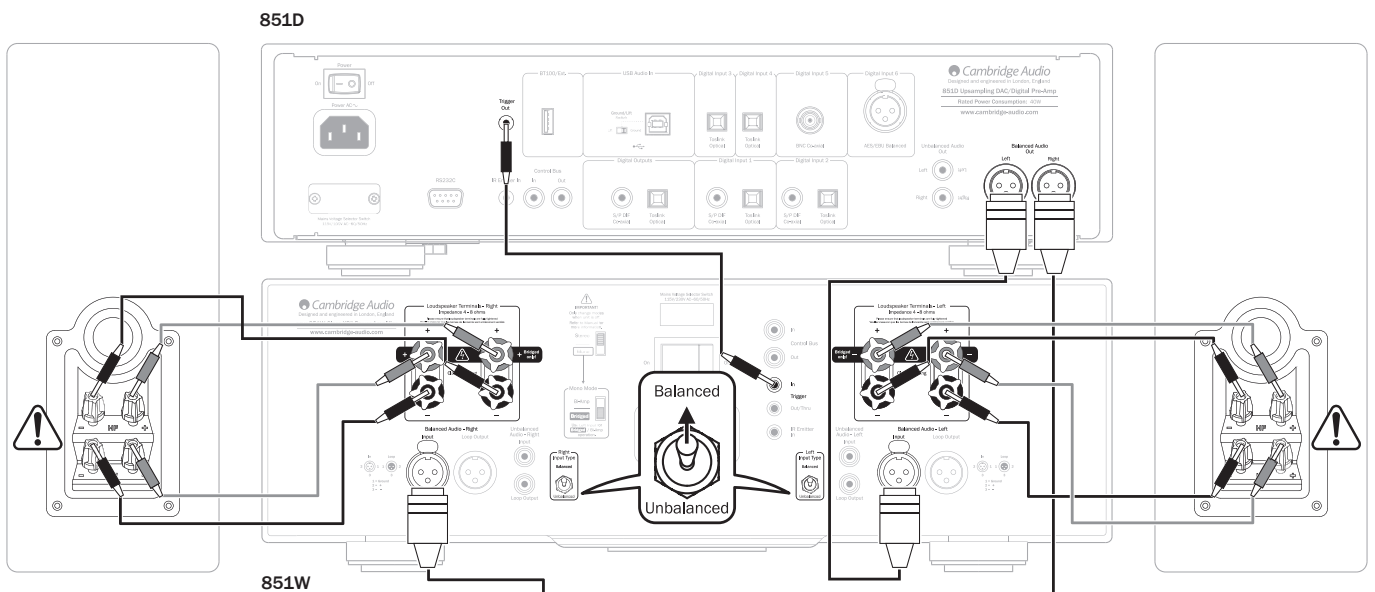

Operating instructions

The 851D has a custom-made display on the front of the unit that shows the current status and allows you to access the system settings menu. Here you can adjust the listening settings to your personal preference. The system menu is easy to navigate and control, simply by using the input select buttons to turn a feature on (solid circle) or off (no circle) and the volume control knob to increase/decrease settings.

Note: To exit the System settings menu or go back one level, press the Menu button.

Selecting input source

Push the appropriate input selection button to select the source component that you wish to listen to (highlighted by a solid circle on the display).

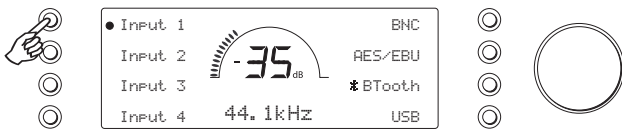

Filter and phase selection

Press the relevant input select button for four seconds to access the submenu. Choose either of the three filter or the phase by pressing the corresponding button. See later section for further details.

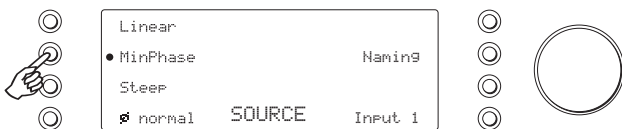

Note: The 851D remembers and recalls the selected filter type for each input individually, making it possible, for example, to select Steep for the USB input and Linear Phase for Digital Input 1, and so on.

Changing input names / source naming

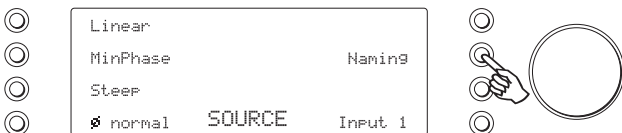

Press the relevant input select button for four seconds to access the submenu. Press the Naming button, for example, if Input 1 is a CD player, name it "CD" etc. Letters are selected by turning the volume control to scroll through the available characters. Press the 'Left' or 'Right' button to select which character you wish to edit. Press the 'Done' button to save and exit the input name change menu and return to the previous menu.

Alternatively, you can change the input name source by pressing the Menu button then navigating to 'Source > Naming'.

USB audio

The 851D is both USB 2.0 (Hi-Speed) and USB 1.1 (Full-speed) USB port compatible.

It will also work with the new USB 3.0 ports where the PC will simply treat the 851D as if it were a USB 2.0 or 1.1 device.

The 851D also supports two USB Audio protocols (not the same as the port types themselves) USB Audio 1.0 (which works over USB 1.1 ports and supports up to 24-bit/96kHz) or USB Audio 2.0 (which requires a USB 2.0 port and can support up to 24-bit/192kHz).

The default configuration is USB 2.0 and USB Audio 2.0 which works with nearly all common operating systems and computer types without drivers and supports up to 24-bit/96kHz audio, simply plug in and play.

In this configuration the 851D is able to work at up to 24-bit/96kHz by declaring to your computer that it can handle any sample rate from 32kHz to 96kHz.

However in some Windows/Mac operating system variants the operating system itself may restrict or fix the output sample rate or re-sample the audio.

See our online guide at www.cambridge-audio.com/851DSupport on USB Audio for more details on this. With careful choice of playback software and settings many pitfalls can be avoided.

In particular our free Windows USB Audio 2.0 driver (available from our website) supports up to 24-bit/192kHz audio and WASAPI Exclusive or ASIO modes that can give enhanced performance.

Switching between USB Class 1 and USB Class 2 operation

Your 851D will come set to driverless USB Audio Class 1 by default, but it can be configured to run in either USB Class 1 or 2 mode. To change USB Class, press the Menu button, then press the USB button to switch between USB 1 and 2 class.

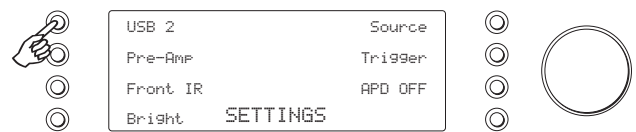

Use with PCs

With the 851D switched to USB Audio 2.0, the 851D needs the Cambridge Audio USB Audio 2.0 Driver to be loaded and can then accept up to 24-bit/192kHz (and support ASIO and WASAPI Exclusive if required).

With the 851D switched to USB Audio 1.0, the 851D will work with the native Windows XP, Vista, 7 or 8 Audio 1.0 driver (no need to load any new driver) and accept audio up to 24-bit/96kHz.

The driver is available from www.cambridge-audio.com/851DSupport.

Use with Macs

With the 851D switched to USB Audio 2.0 the 851D works with the native Mac OS-X 10.5 (Leopard) or above Audio 2.0 driver and can accept audio up to 24/192kHz.

No extra drivers are required. With the 851D switched to USB Audio 1.0 the 851D will work with the native Mac OS-X 10.5 (Leopard) or above Audio 1.0 driver and accept audio up to 24/96kHz.

Use with Linux

For most builds of Linux with the 851D switched to USB Audio 1.0 the 851D will work with the native Audio 1.0 driver and accept audio up to 24-bit/96kHz.

Some very new builds of Linux are now supporting USB Audio 2.0 for which the 851D should be switched to Audio 2.0 support to accept audio up to 24-bit/192kHz.

For both cases, because Linux builds vary according to their creators choice of software components (including drivers) it is not possible to guarantee operation and Audio drivers may need to be loaded.

'Class drivers', as they are called for generic support of Audio Class 1.0 or Audio Class 2.0 devices, may be available from the Linux community, however we do not supply these.

For full USB audio setup guides and to download the Windows USB 2.0 driver, visit www.cambridge-audio.com

Pre-amp mode

The 851D can optionally be used as a digital pre-amp and connected directly to a suitable power-amp.

To ensure that the Pre-Amp mode is selected, press the Menu button then select the Pre-Amp item.

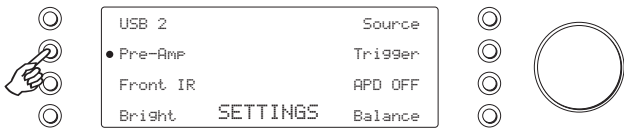

Once Pre-Amp is enabled, the handset Volume Up and Down buttons and the Volume knob on the front panel will affect the signal output level from the 851D. A Balance (Channel Balance) option is also available in the menu structure.

The level at both the balanced XLR and single-ended Phono/RCA outputs is affected and either connection type can be used, see previous 'Balanced' and 'Unbalanced' diagrams.

To disable the Pre-Amp mode, select the button again and a display will ask you to confirm your selection.

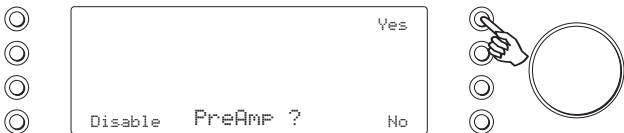

Press the Yes button to confirm.

Be careful not to disable the Pre-Amp when connected to a power amplifier in this way, as this returns the output level to an un-adjustable maximum level for use only into an integrated amplifier or pre-amplifier with its own volume control.

Balance

When the 851D is in Pre-Amp mode, the Balance menu item will be available. Press the Balance menu item button to enter the balance mode.

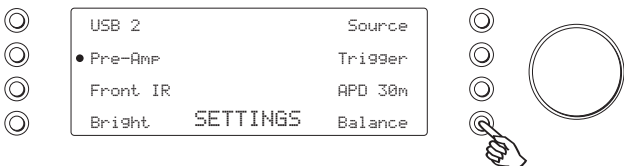

BALANCE will appear on the display and can be adjusted using the volume control.

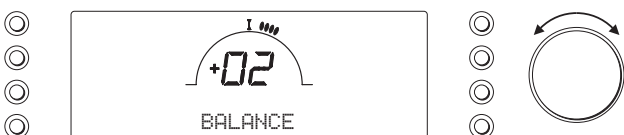

This allows adjustment of the relative level between left and right channels for circumstances where one speaker is further away than the other or the source material itself has a channel imbalance.

Front IR

Used in conjunction with Custom Installation (C.I.) systems or IR repeater systems. It may be desirable to disable the front panel IR by setting Front IR to off, go to Settings menu and press the Front IR button to turn off (the solid circle should not show).

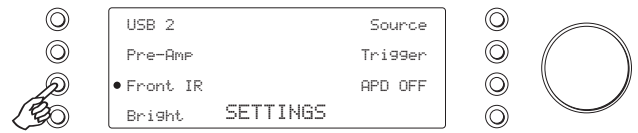

LCD brightness

In the Settings menu, press the Bright button to scroll through bright/dim/off settings for the front panel display.

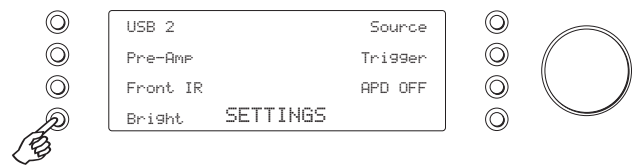

Trigger out

In the System settings menu, press the Trigger input select button to enter the submenu.

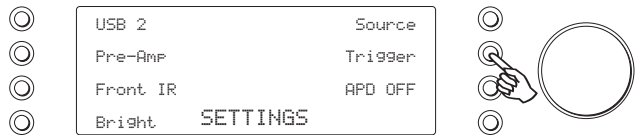

The functions are:

AlwaysOn - Trigger will always be enabled when unit is not in standby.

BySource - Trigger will be enabled when a source is selected. Sources can individually be selected: Input 1-4, BNC, AES/EBU, Bluetooth and USB. To select this function, press the Sources button then select the trigger source/s.

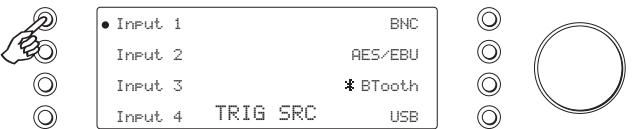
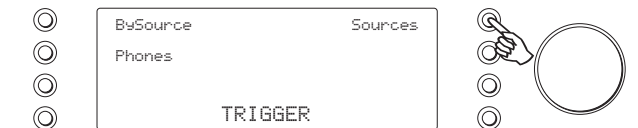

Phones - When this mode is enabled, trigger output will be disabled when headphones are plugged in.

Auto Power Down (APD)

This product has APD (Auto Power Down) enabled as default. After inactivity of 30 minutes, the product will automatically switch to Standby. Changing the default settings can be done by going to the Settings menu and by pressing the APD item button to cycle through the different options. The options are: 2hrs, 1hr, 30 minutes and Off.

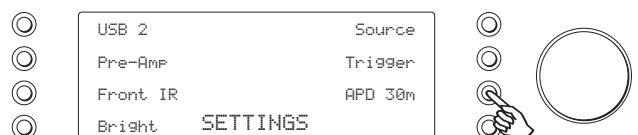

Bluetooth

The 851D is supplied with a BT100 Bluetooth adaptor. This allows the 851D to receive wireless Bluetooth audio from suitable phones/tablets and laptops.

To send Bluetooth audio to the BT100 you must first pair your phone/tablet or laptop with the BT100.

1. Connect the BT100 to the BT100 USB socket on the rear of the 851D.
2. Put the BT100 in pairing mode by pressing and holding the Bluetooth button on the remote control for 4-5 seconds, or by double pressing the button on the BT100 itself.

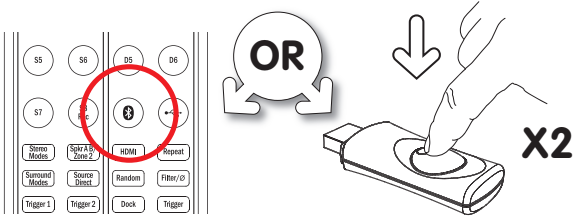

3. Now pair with your phone/tablet/computer (you may need to consult your Bluetooth device's user manual for details). You only need to do this the once, as the BT100 will remember your Bluetooth device the next time you wish to use it.

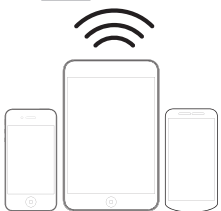
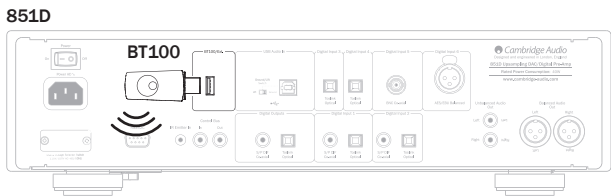

Bluetooth devices

4. With a BT100 installed and paired to your device, press the BTooth select button or the Bluetooth button on the remote to start listening to your music.

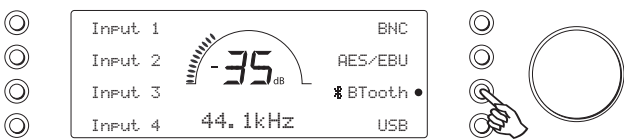

Filters

The 851D DSP has three different Filter functions: Linear Phase, Minimum Phase and Steep. All three filters are highly sophisticated audiophile topologies, optimised specifically for audio playback. In our opinion, these filters offer excellent sound quality but differ subtly in optimisation, hence we've made all three available to you.

Note: For clarity, all diagrams show the theoretical response of the DSP itself, excluding any analogue filtering at the DAC output or the anti-aliasing filter applied during recording and/or mastering of the digital source.

Linear phase filter

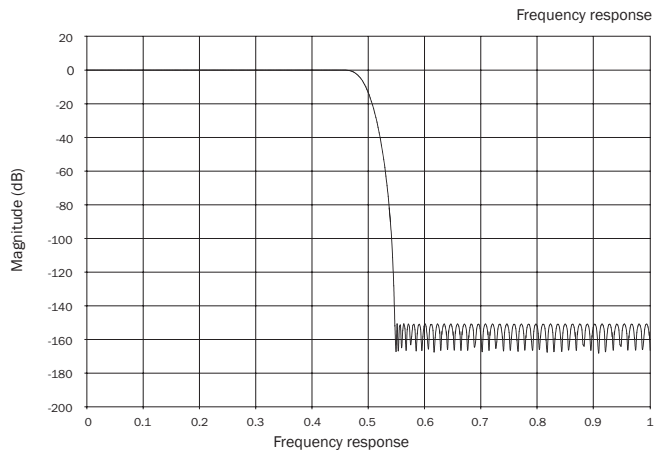

The Linear Phase filter is a highly regarded audio filter offering low ripple in both the pass and stop bands, and what is known as constant group delay. Constant group delay means that audio signals of all frequencies are always delayed by the same amount when passing through the filter. All audio is therefore fully time-coherent at the output.

The trade-off with this type of filter is that due to internal feed-forward in the DSP, its impulse response will exhibit some pre-ringing. In other words, when excited with a theoretical impulse, the output has both a small amount of pre- and post-spike amplitude ringing (albeit well damped).

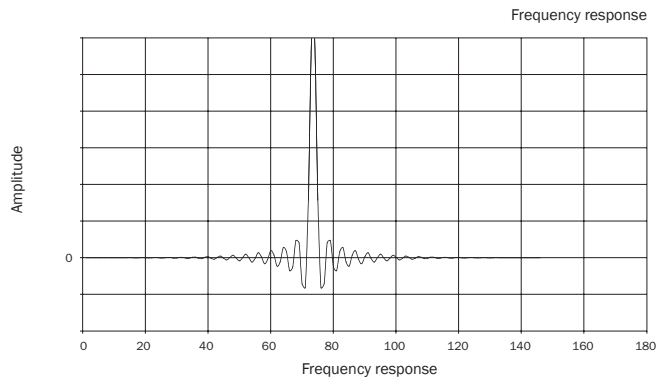

Minimum phase filter

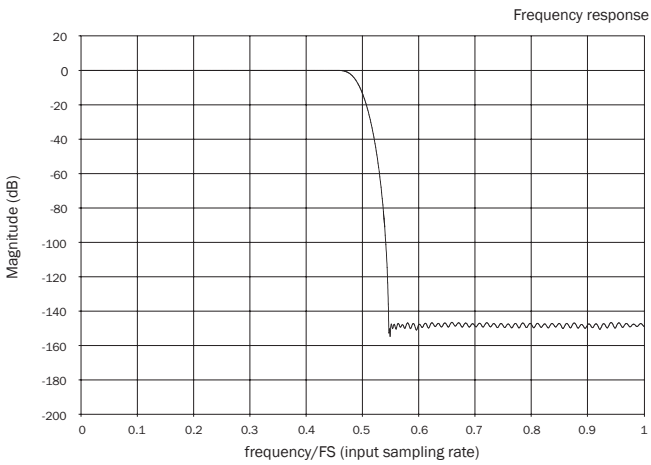

The Minimum Phase filter is another highly regarded audio filter that offers even lower ripple in the pass and stop bands. Unlike the Linear Phase filter, group delay is not constant; however, phase shift is low and the particular benefit with this filter is that the impulse response exhibits no pre-ringing.

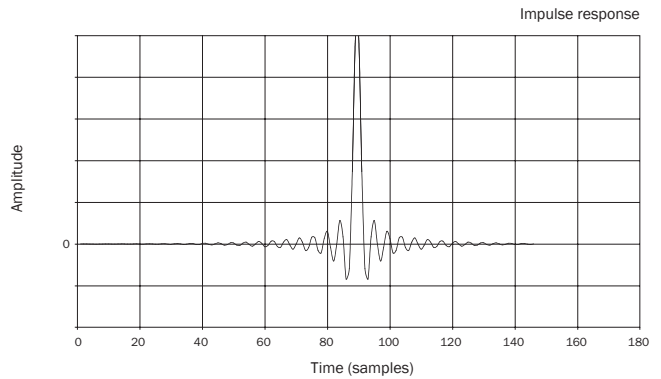
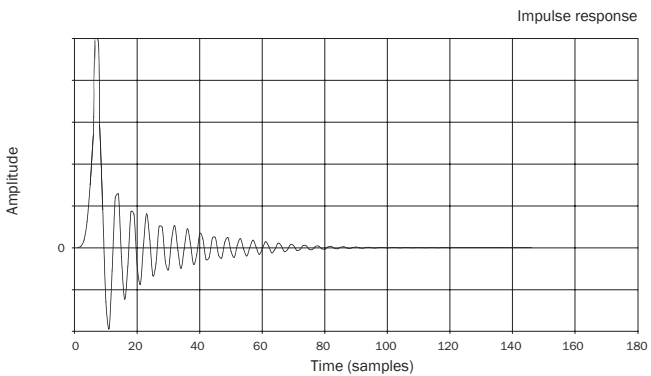

Note: All filters exhibit the same ultimate roll-off of approximately 140dB. The following table shows the filter stop band attenuation for 44.1kHz material:

	Linear Phase	Minimum Phase	Steep
Roll-off at 20kHz	-0.1dB	-0.1dB	-2dB
Roll-off at 22kHz	-10dB	-10dB	-82dB
Ultimate roll-off	140dB	140dB	140dB

We encourage you to experiment with the filters to determine which sound best to your ears and using your source equipment/programme material. The 851D remembers and recalls the selected filter type for each input individually, making it possible, for example, to select Steep for the USB input and Linear Phase for Digital Input 1, and so on.

Step filter

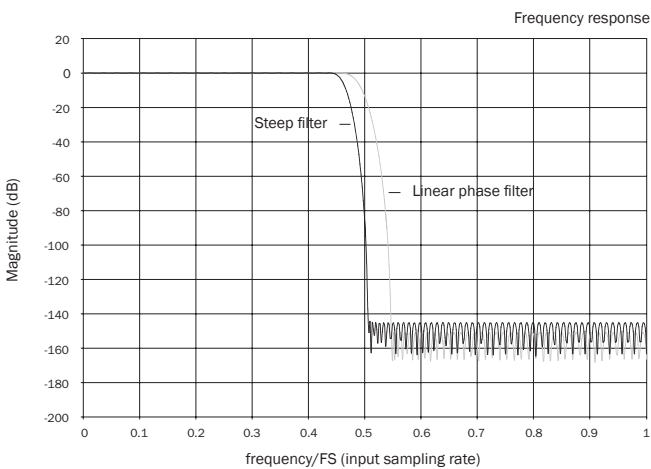

Our Steep filter is a linear phase filter that has been optimised for stop band attenuation of close-in aliasing images. Here we have traded a little attenuation of the very highest frequency response (-2dB at 20kHz for 44.1kHz material) and a little more pre- and post-ringing for a very steep attenuation just outside the pass band. The Steep filter is able to attenuate aliasing at 22kHz by some 80dB for 44.1kHz material for instance.

Custom installation (C.I.) use

The 851D features a Control Bus input/output that allow un-modulated remote control commands (positive logic, TTL level) to be received electrically by the unit and looped to another unit if desired. These control commands are typically generated by custom installation (multi-room) systems or remote IR receiver systems. The Control Bus sockets are colour-coded orange.

An IR Emitter Input is also provided that allows modulated IR remote control commands to be received electrically by the unit. Commands on this input operate the unit only and are not looped out demodulated on the Control Bus Output.

An RS232C port is also featured which allows the 851D to be controlled by C.I. systems.

In addition the units feature 'direct' IR/Control codes as well as toggle codes for some of their features to simplify programming custom installation systems. Special direct On/Off and Mute commands can be accessed on the supplied remote control for teaching into C.I. systems as follows:

1. Press and hold the Standby/On button. The remote first generates it's standby (toggle) command. Keep the button held down, after 12 seconds an amplifier "On" command will be generated. If the button is kept held down for a further 12 seconds, an amplifier player "Off" command is generated.
2. Press and hold the Mute button. The remote first generates it's mute (toggle) command. Keep the button held down, after 12 seconds a "Mute on" command will be generated. If the button is kept held down for a further 12 seconds, a "Mute off" command is generated.

A full code table and RS232 protocol for this product is available on the Cambridge Audio website: www.cambridge-audio.com

Troubleshooting

The 851D is a complex product but even so, should things seem not quite right, the answer is very often a simple one.

There is no power

Ensure the AC power cord is connected securely.

Ensure the plug is fully inserted into the wall socket and is switched on.

Check fuse in the mains plug or adaptor.

There is no sound

Ensure that the unit is configured correctly.

Check that the interconnects are inserted correctly.

There is a hum coming from the speaker

Ensure that all cable connections are secure.

If USB playback, set the USB Ground Lift Switch to "Lift".

The remote handset will not function

Check that the batteries have not expired.

Ensure that nothing is blocking the remote sensor.

For more frequently asked questions (FAQ's), technical advice and information on getting the most out of your 851D, please visit the Support section on Cambridge Audio's website:

www.cambridgeaudio.com/support.php

For all servicing, in or out of warranty, please contact your dealer.

Technical specifications

All measurements are for 24-bit signals via the digital inputs so as not to be source material limited unless stated.

D/A converters	Dual Analog Devices AD1955 24-bit DACs
Digital filter	Analog Devices Black Fin ADSP-BF532 32-bit DSP performing 2nd Generation ATF2 up-sampling to 24-bit 384kHz Linear, Minimum, Steep or Phase modes.
Analog filter	2 Pole Fully Differential Linear Phase Bessel filter
Digital Input 1 and 2	S/PDIF 75 ohms or TosLink optical
Digital Input 3 and 4	TosLink optical
Digital Input 5	BNC Co-axial 75 ohms
Digital Input 6	XLR balanced 110 ohms per phase
USB Audio Input	USB Type B conforming to Audio profile 1.0 or USB Audio profile 2.0 (user selectable)
Compatibility	USB 1.0: 24-bit 44.1kHz, 48kHz, 96kHz USB 2.0: 16/24-bit 44.1kHz, 48kHz, 88.2kHz, 96kHz, 176.4kHz, 192kHz Toslink: 16/24-bit 32-192kHz BNC, S/PDIF and AES/EBU: 16/24-bit 32-192kHz

Dimensions - H x W x D	115 x 430 x 360 mm (4.5 x 16.9 x 14.7")
Max power consumption	40W
Idle consumption	8W approx
Standby power consumption	<0.5W
Weight	7.5kg (16.5lbs)

Line level / balanced output

Frequency response	20Hz to 20kHz (+/-0.1dB)
THD @ 1Khz 0dBFs	< 0.0004%
THD @ 1Khz -10dBFs	< 0.0004%
THD @ 20Khz 0dBFs	< 0.0007%
IMD (19/20kHz) 0dBFs	< 0.0002%
Linearity @ -90dBFs	+/- 0.2dB
Linearity @ -120dB	+/- 0.4dB
Stop-band rejection (>24kHz)	> 120dB
S/N ratio, A weighted	> 113dB
Total correlated jitter	< 60pS for all digital inputs and USB 2.0 < 180pS for USB 1.0
Crosstalk @1kHz	< -130dB
Crosstalk @20kHz	< -114dB
Output impedance	< 50 ohms
0dB Fs Output	2.2Vrms (2.2Vrms each phase for the balanced output)

Headphones

Connector	1 x ¼"/6.35mm Headphone output
Compatibility	12 - 600 ohms
Frequency response	20Hz to 20kHz (+/-0.1dB)
THD @ 1Khz 0dBFs	< 0.0007%
THD @ 1Khz -10dBFs	< 0.0019%
THD @ 20Khz 0dBFs	< 0.0009%

(Measurements taken into a 32 ohm load)

Cambridge Audio is a brand of Audio Partnership Plc
Registered Office: Gallery Court, Hankey Place
London SE1 4BB, United Kingdom
Registered in England No. 2953313

www.cambridge-audio.com

