

Integrated amplifier
User's manual
2

ENGLISH

azur

651A

 **Cambridge Audio**
Your music + our passion

Contents

Introduction	2
Important safety instructions	3
Limited warranty	4
Rear panel connections	5
Connections	6
Front panel controls	9
Apple device compatibility	10
Remote control	10
Custom installation (C.I.) use	11
CAP5: Five-way protection system	11
Technical specifications	12
Troubleshooting	12

Introduction

Thank you for purchasing this 651A Amplifier. We are confident that you will enjoy many years of listening pleasure from it. Like all Cambridge Audio products the 651A adheres to our three core principles – stunning performance, ease of use and incredible value.

Developed as part of our on-going research and development regime, including extensive listening tests, we have incorporated many subtle tweaks and improvements to our circuits, components and layouts in the pursuit of our passion for sound quality.

Very high quality components are used throughout including an Alps volume pot, polypropylene signal capacitors, gold-plated speaker outputs, custom-made electrolytic capacitors in critical positions and several new circuit tweaks. The amplifier is a completely discrete bipolar transistor-based circuit honed over many years powered from a bespoke audiophile-grade toroidal transformer.

Also featured is an environmentally friendly low power (<0.5W) standby circuit. This circuit completely powers down the amplifier circuits in Standby mode yet is itself totally isolated when the amplifier is on, thus having no effect on sound quality.

All this proprietary engineering is housed within our low resonance, acoustically damped chassis. An Azur Navigator remote control is also provided, giving full remote control of your amplifier in an attractive and easy to use handset.

Remember your 651A can only be as good as the system it is connected to. Please do not compromise on your source equipment, speakers or cabling.

Naturally we particularly recommend source components from the Cambridge Audio Azur range which includes CD players, BD/DVD/SACD/DVD players, iPod docks and Network players which have been designed to the same exacting standards as this amplifier.

Your dealer can also supply excellent quality Cambridge Audio interconnects to ensure your system realises its full potential.

Thanks for taking the time to read this manual, we do recommend you keep it for future reference.



Matthew Bramble
Cambridge Audio Technical Director
and the 651A design team

Make sure you register your purchase.

Visit: www.cambridgeaudio.com/sts

By registering, you'll be the first to know about:

- Future product releases
- Software upgrades
- News, events and exclusive offers plus competitions!

This guide is designed to make installing and using this product as easy as possible. Information in this document has been carefully checked for accuracy at the time of printing; however, Cambridge Audio's policy is one of continuous improvement, therefore design and specifications are subject to change without prior notice.

This document contains proprietary information protected by copyright. All rights are reserved. No part of this manual may be reproduced by any mechanical, electronic or other means, in any form, without prior written permission of the manufacturer. All trademarks and registered trademarks are the property of their respective owners.

© Copyright Cambridge Audio Ltd 2013

Important safety instructions

For your own safety please read the following important safety instructions carefully before attempting to connect this unit to the mains power supply. They will also enable you to get the best performance from and prolong the life of the unit:

1. Read these instructions.
2. Keep these instructions.
3. Heed all warnings.
4. Follow all instructions.
5. Do not use this apparatus near water.
6. Clean only with a dry cloth.
7. Do not block any ventilation openings. Install in accordance with the manufacturer's instructions.
8. Do not install near any heat sources such as radiators, heat registers, stoves, or other apparatus (including other amplifiers) that produce heat.
9. Do not defeat the safety purpose of the polarized or grounding-type plug. A polarized plug has two blades with one wider than the other. A grounding-type plug has two blades and a third grounding prong. The wide blade or the third prong are provided for your safety. If the provided plug does not fit into your outlet, consult an electrician for replacement of the obsolete outlet.
10. Protect the power cord from being walked on or pinched, particularly at plugs, convenience receptacles and the point where they exit from the apparatus.
11. Only use attachments/accessories specified by the manufacturer.
12. Use with only the cart, stand, tripod, bracket, or table specified by the manufacturer, or sold with the apparatus. When a cart is used, use caution when moving the cart/apparatus combination to avoid injury from tip-over. 
13. Unplug this apparatus during lightning storms or when unused for long periods of time.
14. Refer all servicing to qualified service personnel. Servicing is required when the apparatus has been damaged in any way, such as the power-supply cord or plug having been damaged, liquid has been spilled or objects have fallen into the apparatus, the apparatus has been exposed to rain or moisture, does not operate normally, or has been dropped.

WARNING

- To reduce the risk of fire or electric shock, do not expose this unit to rain or moisture.
- Batteries (battery pack or batteries installed) shall not be exposed to excessive heat such as sunshine, fire or the like.

The unit is of Class 1 construction and must be connected to a mains socket outlet with a protective earthing connection.

The unit must be installed in a manner that makes disconnection of the mains plug from the mains socket outlet (or appliance connector from the rear of the unit) possible. Where the mains plug is used as the disconnect device, the disconnect device shall remain readily operable. Only use the mains cord supplied with this unit.

Please ensure there is ample ventilation. We recommend that you do not place the unit in an enclosed space; if you wish to place the unit on a shelf, use the top shelf to allow maximum ventilation. Do not put any objects on top of this unit. Do not situate it on a rug or other soft surface and do not obstruct any air inlets or outlet grilles. Do not cover the ventilation grilles with items such as newspapers, tablecloths, curtains, etc.

This unit must not be used near water or exposed to dripping or splashing water or other liquids. No objects filled with liquid, such as vases, shall be placed on the unit.



The lightning flash with the arrowhead symbol within an equilateral triangle is intended to alert the user to the presence of un-insulated 'dangerous voltage' within the product's enclosure that may be of sufficient magnitude to constitute a risk of electric shock to persons.

The exclamation point within an equilateral triangle is intended to alert the user to the presence of important operating and maintenance instructions in the service literature relevant to this appliance.

WEEE symbol



The crossed-out wheeled bin is the European Union symbol for indicating separate collection for electrical and electronic equipment. This product contains electrical and electronic equipment which should be reused, recycled or recovered and should not be disposed of with unsorted regular waste. Please return the unit or contact the authorised dealer from whom you purchased this product for more information.

CE mark



This product complies with European Low Voltage (2006/95/EC), Electromagnetic Compatibility (2004/108/EC) and Environmentally-friendly design of Energy-related Products (2009/125/EC) Directives when used and installed according to this instruction manual. For continued compliance only Cambridge Audio accessories should be used with this product and servicing must be referred to qualified service personnel.

C-Tick mark



This product meets the Australian Communications Authority's Radio communications and EMC requirements.

Gost-R stamp



This product meets Russian electronic safety approvals.

FCC regulations

NOTE: THE MANUFACTURER IS NOT RESPONSIBLE FOR ANY RADIO OR TV INTERFERENCE CAUSED BY UNAUTHORIZED MODIFICATIONS TO THIS EQUIPMENT. SUCH MODIFICATIONS COULD VOID THE USER AUTHORITY TO OPERATE THE EQUIPMENT.



This equipment has been tested and found to comply with the limits for a Class B digital device, pursuant to Part 15 of the FCC Rules. These limits are designed to provide reasonable protection against harmful interference in a residential installation. This equipment generates, uses and can radiate radio frequency energy and, if not installed and used in accordance with the instructions, may cause harmful interference to radio communications. However, there is no guarantee that interference will not occur in a particular installation.

If this equipment does cause harmful interference to radio or television reception, which can be determined by turning the equipment off and on, the user is encouraged to try to correct the interference by one or more of the following measures:

- Re-orient or relocate the receiving antenna.
- Increase the separation between the equipment and receiver.
- Connect the equipment into an outlet on a circuit different from that to which the receiver is connected.
- Consult the dealer or an experienced radio/TV technician for help.

Ventilation

IMPORTANT – The unit will become hot when in use. Do not place anything on top of the unit. Do not place in an enclosed area such as a bookcase or in a cabinet without sufficient ventilation.

Ensure that small objects do not fall through any ventilation grille. If this happens, switch off immediately, disconnect from the mains supply and contact your dealer for advice.

Positioning

Choose the installation location carefully. Avoid placing it in direct sunlight or close to a source of heat. No naked flame sources, such as lighted candles, should be placed on the unit. Also avoid locations subject to vibration and excessive dust, cold or moisture. The unit can be used in a moderate climate.

This unit must be installed on a sturdy, level surface. Do not place in a sealed area such as a bookcase or in a cabinet. Do not place the unit on an unstable surface or shelf. The unit may fall, causing serious injury to a child or adult as well as serious damage to the product. Do not place other equipment on top of the unit.

Due to stray magnetic fields, turntables or CRT TVs should not be located nearby due to possible interference.

Electronic audio components have a running in period of around a week (if used several hours per day). This will allow the new components to settle down and the sonic properties will improve over this time.

Power sources

The unit should be operated only from the type of power source indicated on the marking label. If you are not sure of the type of power-supply to your home, consult your product dealer or local power company.

This unit can be left in Standby mode when not in use and will draw <0.5W in this state. To turn the unit off, switch off at the rear panel. If you do not intend to use this unit for a long period of time, unplug it from the mains socket.

Overloading

Do not overload wall outlets or extension cords as this can result in a risk of fire or electric shock. Overloaded AC outlets, extension cords, frayed power cords, damaged or cracked wire insulation and broken plugs are dangerous. They may result in a shock or fire hazard.

Be sure to insert each power cord securely. To prevent hum and noise, do not bundle the interconnect leads with the power cord or speaker leads.

Cleaning

To clean the unit, wipe its case with a dry, lint-free cloth. Do not use any cleaning fluids containing alcohol, ammonia or abrasives. Do not spray an aerosol at or near the unit.

Battery disposal

Please dispose of any discharged batteries according to local environmental/electronic waste disposal guidelines.

Loudspeakers

Before making any connections to loudspeakers, make sure all power is turned off and only use suitable interconnects.

Servicing

These units are not user serviceable. Never attempt to repair, disassemble or reconstruct the unit if there seems to be a problem. A serious electric shock could result if this precautionary measure is ignored. In the event of a problem or failure, please contact your dealer.

Limited warranty

Cambridge Audio warrants this product to be free from defects in materials and workmanship (subject to the terms set forth below). Cambridge Audio will repair or replace (at Cambridge Audio's option) this product or any defective parts in this product. Warranty periods may vary from country to country. If in doubt consult your dealer and ensure that you retain proof of purchase.

To obtain warranty service, please contact the Cambridge Audio authorised dealer from which you purchased this product. If your dealer is not equipped to perform the repair of your Cambridge Audio product, it can be returned by your dealer to Cambridge Audio or an authorised Cambridge Audio service agent. You will need to ship this product in either its original packaging or packaging affording an equal degree of protection.

Proof of purchase in the form of a bill of sale or receipted invoice, which is evidence that this product is within the warranty period, must be presented to obtain warranty service.

This Warranty is invalid if (a) the factory-applied serial number has been altered or removed from this product or (b) this product was not purchased from a Cambridge Audio authorised dealer. You may call Cambridge Audio or your local country Cambridge Audio distributor to confirm that you have an unaltered serial number and/or you made a purchase from a Cambridge Audio authorised dealer.

This Warranty does not cover cosmetic damage or damage due to acts of God, accident, misuse, abuse, negligence, commercial use, or modification of, or to any part of, the product. This Warranty does not cover damage due to improper operation, maintenance or installation, or attempted repair by anyone other than Cambridge Audio or a Cambridge Audio dealer, or authorised service agent which is authorised to do Cambridge Audio warranty work. Any unauthorised repairs will void this Warranty. This Warranty does not cover products sold AS IS or WITH ALL FAULTS.

REPAIRS OR REPLACEMENTS AS PROVIDED UNDER THIS WARRANTY ARE THE EXCLUSIVE REMEDY OF THE CONSUMER. CAMBRIDGE AUDIO SHALL NOT BE LIABLE FOR ANY INCIDENTAL OR CONSEQUENTIAL DAMAGES FOR BREACH OF ANY EXPRESS OR IMPLIED WARRANTY IN THIS PRODUCT. EXCEPT TO THE EXTENT PROHIBITED BY LAW, THIS WARRANTY IS EXCLUSIVE AND IN LIEU OF ALL OTHER EXPRESS AND IMPLIED WARRANTIES WHATSOEVER INCLUDING, BUT NOT LIMITED TO, THE WARRANTY OF MERCHANTABILITY AND FITNESS FOR A PRACTICAL PURPOSE.

Some countries and US states do not allow the exclusion or limitation of incidental or consequential damages or implied warranties so the above exclusions may not apply to you. This Warranty gives you specific legal rights, and you may have other statutory rights, which vary from state to state or country to country.

For any service, in or out of warranty, please contact your dealer.

Plug-fitting Instructions (UK only)

The cord supplied with this appliance is factory-fitted with a UK mains plug fitted with a 5-amp fuse inside. If it is necessary to change the fuse, it is important that a 5-amp fuse is used. If the plug needs to be changed because it is not suitable for your socket, or becomes damaged, it should be cut off and an appropriate plug fitted following the wiring instructions below. The plug must then be disposed of safely, as insertion into a mains socket is likely to cause an electrical hazard. Should it be necessary to fit a 3-pin BS mains plug to the power cord, the wires should be fitted as shown in this diagram. The colours of the wires in the mains lead of this appliance may not correspond with the coloured markings identifying the terminals in your plug. Connect them as follows:

The wire which is coloured BLUE must be connected to the terminal which is marked with the letter 'N' or coloured BLACK.

The wire which is coloured BROWN must be connected to the terminal which is marked with the letter 'L' or coloured RED.

The wire which is coloured GREEN/YELLOW must be connected to the terminal which is marked with the letter 'E' or coloured GREEN.

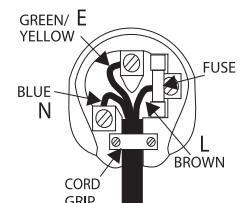

If a standard 13-amp (BS 1363) plug is used, a 5-amp fuse must be fitted or, if any other type of plug is used, a 5-amp fuse must be fitted, either in the plug or adaptor, or on the distribution board.

Rear panel connections

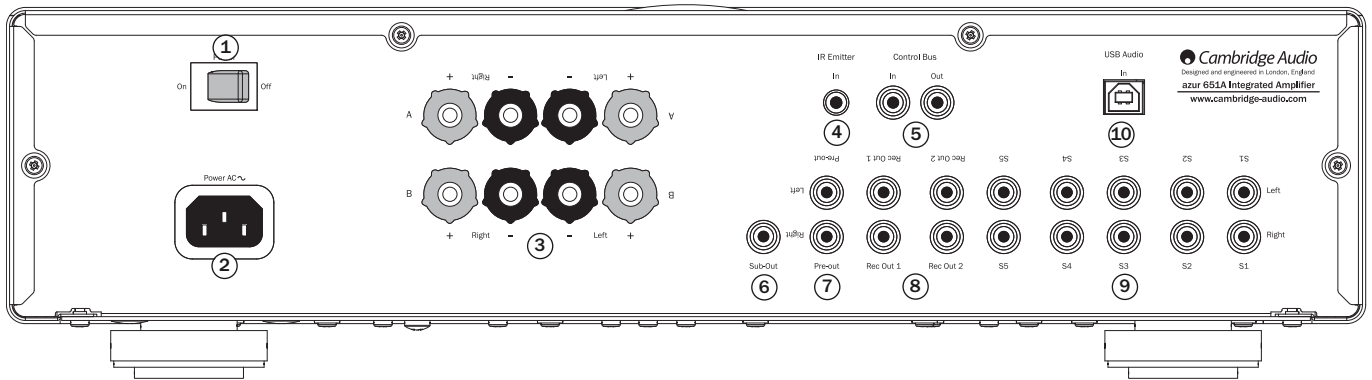

① Power On/Off

Switches the unit on and off. This switch is a master on/off control that completely powers down the unit.

② AC power socket

Once you have completed all connections to the amplifier, plug the AC power cable into an appropriate mains socket and turn the unit on. Your amplifier is now ready for use.

③ Loudspeaker terminals

Two sets of loudspeaker terminals are available, **A** (main loudspeaker terminals, top row) and **B** (secondary switchable loudspeaker terminals, bottom row). Connect the wires from your left channel loudspeaker to the LEFT positive and negative terminals, and the wires from the right channel loudspeaker to the RIGHT positive and negative terminals. In each case, the red terminal is the positive output and the black terminal is the negative output.

Care should be taken to ensure no stray strands of wire are shorting speaker outputs together. Please ensure that the loudspeaker terminals have been tightened adequately to provide a good electrical connection. It is possible for the sound quality to be affected if the screw terminals are loose.

The use of A and B speakers affords you an easy and inexpensive way to create a simple multi-room system.

Note: When using two pairs of speakers, use speakers with a minimum nominal impedance of 8 ohms.

④ IR (Infrared) Emitter In

Allows modulated IR commands from multi-room systems or IR repeater systems to be received by the amplifier. Commands received here are not looped out of the Control Bus. Refer to the 'Custom Installation' section for more information.

⑤ Control Bus

In Allows un-modulated commands from multi-room systems or other components to be received by the unit.

Out Loop out for control bus commands to another unit.

⑥ Sub-Out

This output can be used to connect to a subwoofer, if desired.

⑦ Pre-Out

These outputs can be used to connect to the inputs on an external power amplifier or an active subwoofer, etc.

⑧ Record Out 1/2

These two identical output sockets can be connected to a tape deck or to the analogue Record In sockets on a MiniDisc or CD recorder etc.

⑨ S1-S5

These inputs are suitable for any 'line level' source equipment such as BD/DVD players, DAB or FM/AM tuners, CD players, Network Players, iPod docks, MP3 players, etc.

Note: These inputs are for analogue audio signals only. They should not be connected to the digital output of a CD player or any other digital device.

Connecting a turntable

If it is desired to connect a turntable without a built-in phono stage, an external phono stage such as our 551P or 651P models should be used. Contact your Cambridge Audio dealer for more details.

Note: A very few turntables have built-in phono stages, in which case it is not necessary to use a separate phono stage amplifier. If you're unsure, please consult your turntable user manual.

⑩ USB interface

A USB B type socket is fitted to the 651A to enable the playback of audio from a personal computer running either Microsoft Windows or Apple Mac OS X operating systems. Some builds of Linux are also suitable.

Note: Always use a certified cable for USB Audio preferably one that displays an official mark. USB cable connections longer than 3m may result in inconsistent audio performance.



Always turn the Volume to minimum, or turn the 651A off before plugging/unplugging cables to the USB input or whilst booting up your PC/Mac.

Connections

Note: Before making any connections, make sure that the 651A is turned off.

When designing our amplifiers we include features that allow you to connect your system in various ways. The inclusion of features such as Pre-Out and Speaker B connections mean that you can flexibly configure your system depending on your requirements.

Basic connection

The diagram below shows the basic connection of your amplifier to a CD player and a pair of loudspeakers.

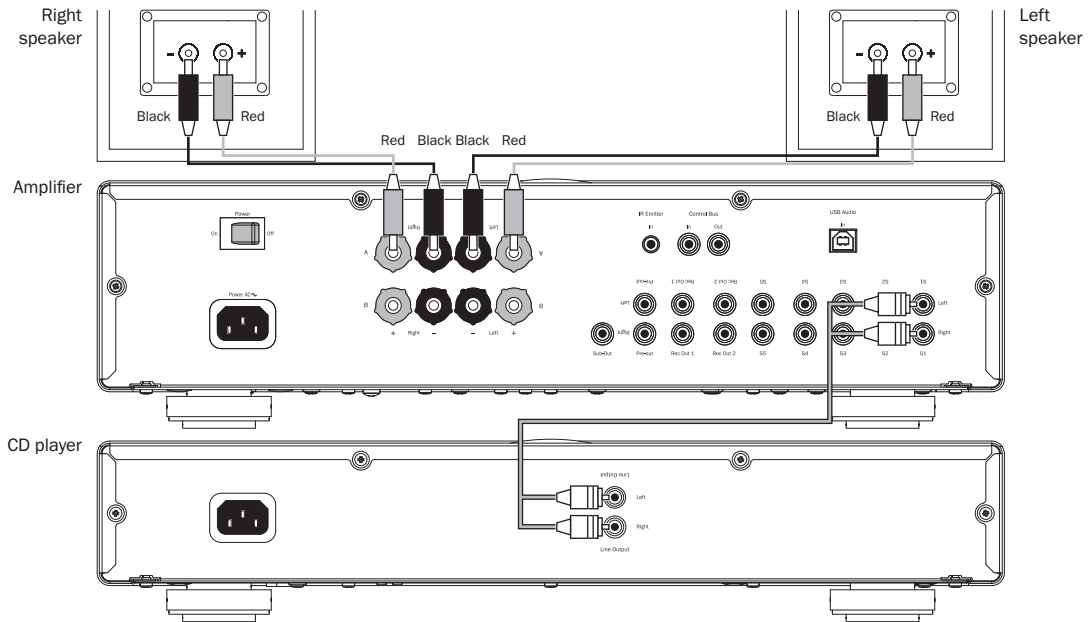

Record out connection

The diagram below shows how to connect the amplifier to a tape recorder or other component with a record function. Please note that either of the record outputs can be used (as they are both the same signal in parallel).

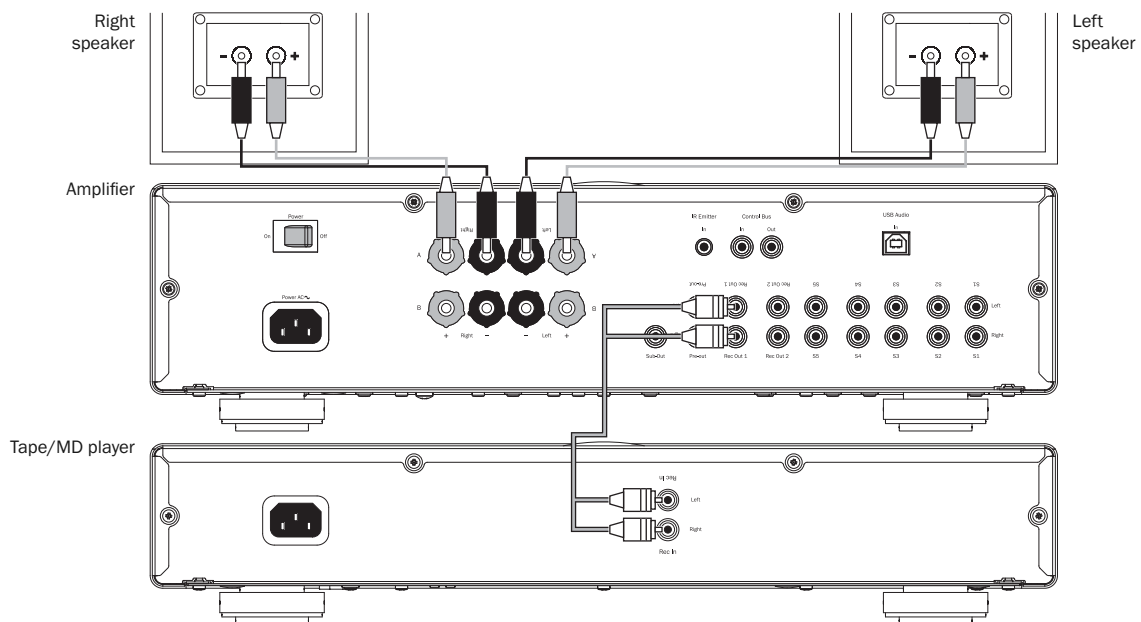

Speaker B connections

The Speaker B connections on the back of the amplifier allow for a second set of speakers to be used (i.e. speakers located in another room). The Speaker A/B button on the remote control allows the two sets of speakers to be toggled on and off. Refer to the Remote Control section of this manual for more information on the Speaker A/B operation.

Set either A or B, or both A and B may be selected for use.

Note: When using two pairs of speakers, use speakers with a minimum nominal impedance of 8 ohms each.

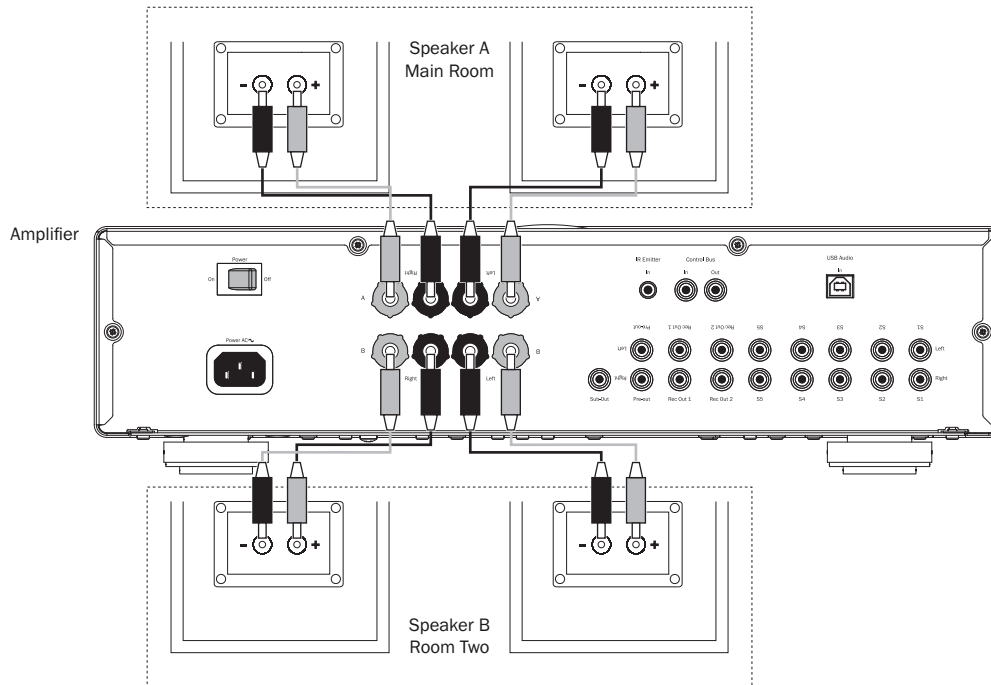

Pre-Out connections

The Pre-Out sockets are for connecting to the input sockets of a power amplifier, or active subwoofer. The diagram below shows how to connect the amplifier to an active subwoofer via either a mono Sub in or Stereo Line In inputs on the subwoofer.

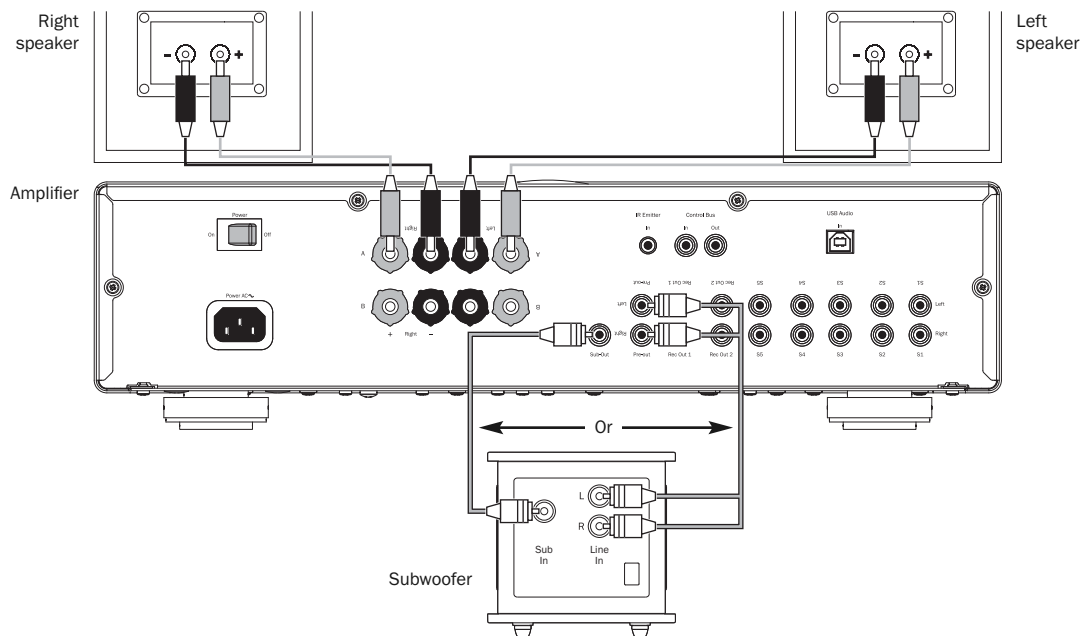

Front panel controls

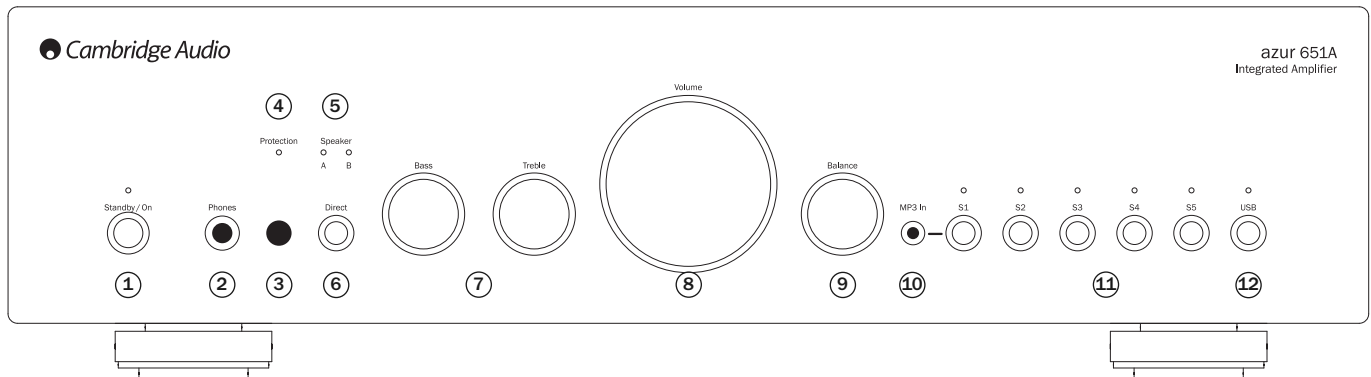

① Standby/On

Switches the unit between Standby mode (indicated by dim power LED) and On (indicated by bright power LED). Standby is a low power mode where the power consumption is less than 0.5 Watts. The unit can be left in Standby mode when not in use.

This product has a permanent APD (Auto Power Down) function. After inactivity of 30 minutes, the product will automatically switch to Standby.

② Phones

Allows for the connection of headphones with a ¼" jack plug connector. Headphones with an impedance of between 32 and 600 ohms are recommended. When the headphones are connected, the output to the loudspeakers is switched off (both speakers A and B).

③ Infrared sensor

Receives IR commands from the supplied Azur remote control. A clear, unobstructed line of sight between the remote control and the sensor is required.

④ Protection

LED flashes to indicate activation of CAP5 protection system. Refer to the CAP5 section of this manual for more information.

⑤ Speaker LEDs

Indicator shows the speaker terminals that are selected. The speaker terminals selected are changed with the remote control.

⑥ Direct

This control gives the audio signal a more direct path to the power amplifier stage of your amplifier, bypassing the bass and treble control circuits for the purest possible sound quality.

⑦ Bass and Treble

These controls allow subtle adjustments to the tonal balance of the sound. In the central position these controls have no effect. They only modify the sound through your loudspeakers and the Pre-Out sockets, and do not affect the signals sent through the Rec Out connections. With well-produced source material and a good system, the tone controls are unnecessary and can be switched out by the 'Direct' switch. If the musical recording is of poor quality or other factors are affecting the sound quality, it may be necessary to adjust the tone controls to compensate.

⑧ Volume

Use to increase or decrease the level of the sound from the outputs of the amplifier. This control affects the level of the loudspeaker output, the pre-amp output and the headphone output. It does not affect the Rec Out connections. It is advisable to turn the Volume control fully anti-clockwise before switching the amplifier on.

⑨ Balance

This control allows you to adjust the relative output levels of the left and right channels. In the central position the output from each channel is equal. This control only modifies the sound through your loudspeakers and the Pre-Out sockets – it does not affect the signals sent through the Rec Out connections.

⑩ S1/MP3 input

This source input allows you to connect a portable audio device such as an MP3 player, plugged into either the rear panel 'S1' Phono/RCA input pair or the front panel 3.5mm stereo-jack input (labelled 'MP3 In').

Press the S1 button on the front panel to select the input, or insert a device into the front panel socket which automatically selects the input and overrides the rear Phono/RCA sockets.

Note: Whilst plugging a device into the front panel automatically selects the MP3 input, any other input can still be selected once this has been done. As a result you may, if desired, leave a device permanently plugged into the front panel.

⑪ S2-S5 Source inputs

Push the appropriate input selection button to select the source component that you wish to listen to. The signal selected is also fed to the Rec Out sockets so that it may be recorded. The input should not be changed whilst recording.

⑫ USB

This source input allows connection of a personal computer via USB.

Remote control

The 651A is supplied with an Azur Navigator remote control that operates both this amplifier and Cambridge Audio Azur range CD players. Insert the supplied AAA batteries to activate. The functions relevant to the amplifier are as follows:

Standby/On

Switches the amplifier between On and Standby mode.

Source

Cycles through the amplifier's source inputs.

Mute

Mutes the audio on the amplifier. The mute mode is indicated by the source LED flashing. Press again to cancel mute.

Note: The speaker outputs, Pre-out and headphone outputs will all be muted. The Record outputs are unaffected.

Speaker A/B

Toggles the speaker terminals on the rear panel to output speaker A only, speaker B only, both speakers A and B or no speaker output at all. The speaker indicators on the front panel of the amplifier show which speaker terminals are selected.

Note: The 'no speaker output' option allows the 651A to be used as a preamplifier only.

Volume controls

Increases or decreases the volume of the amplifier output.



The six source select buttons are used to directly select the input source to the amplifier.

The remaining buttons are reserved for use with Cambridge Audio Azur CD players.

Open/Close

Opens and closes the disc tray

Numerical track select

Press the number of the desired track. The track will then play automatically from the start of the track.

Track select

To select a track number greater than nine, press -/-- followed by the track number. Playback of the chosen track starts automatically.

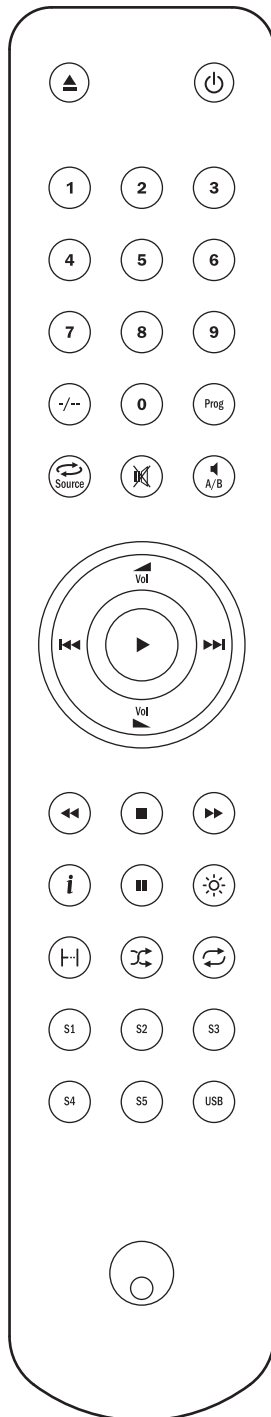

Play/ Stop/ Pause

Press the relevant button to play, stop or pause the CD.

Skip

Right Skip Press to skip forward by one track on the CD.

Left Skip Press to skip backward by one track on the CD.

Scan

Press and hold to scan within the selected track. Hold down for seven seconds to increase scan speed. Press the right button to fast forward, the left button to rewind.

Info

Used with CDs that support CD-text. In stop mode, press to toggle between album name and total time on the display. During playback, press to toggle between track name and track time.

Bright

Alters the brightness of the display backlight. There are three levels of brightness: Bright, Dim and Off.



Read the 'Operating Instructions' section of the Azur CD manual for information on the functions of these buttons.

Note: these buttons will function only when the display backlight is in either 'Bright' or 'Dim' modes. If it is set to 'Off', the functions do not respond.

Apple device compatibility

The Azur 651AC Navigator remote control can control the basic functions of Apple devices such as Apple TV and Apple's iPod/iPhone/iPad range when docked in a Cambridge Audio or Apple dock.

Press and hold the source button that corresponds to the input that the Apple product is connected to whilst also pressing one of the buttons below.

The functions are slightly different depending on the Apple product.

 Select

 Play/pause

 Stop or Menu

 Press briefly to skip or navigate left or right. Press and hold to scan forwards or backwards.

 Used to control volume and/or navigate menus.

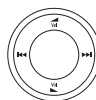

Used to navigate menus.

In addition, the Azur remote can be paired with up to six specific Apple devices using any of the six source buttons. This can be useful if you have more than one Apple product.

For more information on pairing refer to your Apple device's instruction manual.

Pairing – To pair with an Apple device, press and hold the required source button along with the  button for six seconds. Some devices like Apple TV have visual indication once pairing is achieved.

Un-pairing – To un-pair an Apple device, press and hold any of the source buttons along with the  button for six seconds.

CAP5: Five-way protection system

Cambridge Audio has developed a proprietary protection system to ensure reliability and long life of its amplifiers. This protection system comprises five main protection methods:

1. DC detection *

Indicator – Unit has switched off during operation, protection LED constantly flashes in single bursts.

Description – CAP5 offers loudspeaker protection if the output of the amplifier goes to a high constant voltage (DC). This is a rare fault, although detecting it could just save those expensive loudspeakers.

Remedy – Due to the necessary sensitivity of the DC protection circuit, hard clipping of the amplifier may cause DC protection to be triggered. If this fault occurs please switch the unit off, power up again and check operation with a reduced volume level. If the DC fault occurs again please contact your dealer for service.

2. Over temperature detection **

Indicator – Unit has switched off during operation, protection LED constantly flashes in bursts of two.

Description – CAP5 includes temperature detection which constantly monitors the heat generated by the output transistors. If the monitored temperature reaches a high level (suitably within the limits of the output devices) the amplifier will automatically switch into a fault mode. If the loudspeaker impedance is low, the temperature of the amplifier may rise faster as the amplifier is working harder. If the amplifier is mounted in a cabinet or the ventilation slots are obstructed, the over-temperature detection may activate/reactivate after a short listening time.

Remedy – The unit is not damaged, although it should be left for 15 minutes to cool down before being switched out of Standby.

3. Overvoltage/overcurrent detection ***

Indicator – Unit has switched off during operation, protection LED constantly flashes in bursts of three.

Description – CAP5 offers V/I protection by constantly monitoring the output transistors to keep them working inside their Safe Operating Area (SOA). The SOA is a set of limits given by the output transistor manufacturer to ensure reliability. V/I also protects the amplifier against short-circuits on the speaker terminals during use.

Remedy – The amplifier is being used outside its performance envelope. Reduce the volume. Also check to see if there is a short- or partial short-circuit between the loudspeaker terminals.

Note: If the indication remains the same and multiple loudspeakers are being used on each loudspeaker output, then please remove a pair and retry. If too many loudspeakers are connected to any amplifier, causing the load resistance to drop too low, the amplifier will be overdriven. CAP5 will detect this situation. If the indication remains the same with only one set of loudspeakers connected, there may be a fault with one or both of the loudspeakers.

4. Short-circuit detection ****

Indicator – As the unit attempts to come out of Standby mode, the protection LED flashes in bursts of four.

Description – During power up from Standby, CAP5 performs a check on the loudspeaker terminals to see if a short across the terminals has been accidentally introduced. If the resistance measured across the loudspeaker terminals is too low, the unit will remain in Standby mode until the fault has been removed and power up is re-attempted.

Remedy – User-related fault. There may be a short-circuit between the loudspeaker terminals. Check all loudspeaker connections before attempting to switch the unit out of Standby.

5. Intelligent clipping detection ©

Indicator – Volume is nudged down automatically.

Description – CAP5 has the ability to detect when the amplifier starts to clip or overdrive at its output, which can damage loudspeakers and degrade the sound. Clipping distortion is caused at high volume levels when the output signal briefly goes outside the maximum voltage that the amplifier can provide, causing the tops of the signal to flatten off. When CAP5 detects clipping, the volume will be automatically nudged down until CAP5 detects an undistorted output.

The clipping detection is disabled by default. However, to enable the clipping detection, hold down the Standby/On button during power up (whilst switching on the unit at the rear panel power switch). The unit will indicate this by flashing the protection LED for several seconds.

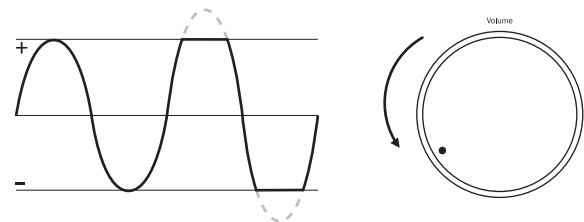

Custom installation (C.I.) use

The 651A feature a Control Bus input/output that allow un-modulated remote control commands (positive logic, TTL level) to be received electrically by the unit and looped to another unit if desired. These control commands are typically generated by custom installation (multi-room) systems or remote IR receiver systems. The Control Bus sockets are colour-coded orange.

An IR Emitter Input is also provided that allows modulated IR remote control commands to be received electrically by the unit. Commands on this input operate the unit only and are not looped out demodulated on the Control Bus Output.

In addition the units feature 'direct' IR/Control codes as well as toggle codes for some of their features to simplify programming custom installation systems. Special direct On/Off and Mute commands can be accessed on the supplied remote control for teaching into C.I. systems as follows:

1. Press and hold the Standby button. The remote first generates its standby (toggle) command. Keep holding the button down and after 12 seconds an amplifier "On" command will be generated. If the button is held down for a further 12 seconds, an amplifier "Off" command is generated.
2. Press and hold the Mute button. The remote first generates its mute (toggle) command. Keep holding the button down and after 12 seconds a "Mute On" command will be generated. If the button is held down for a further 12 seconds, a "Mute Off" command is generated.

A full code table for this product is available on the Cambridge Audio website at www.cambridge-audio.com.

Technical specifications

651A

Power output	75 watts (into 8Ω)
THD (unweighted)	<0.002% @ 1kHz, 80% of rated power <0.03% 20Hz - 20kHz, 80% of rated power <0.02% 20Hz - 20kHz @ 10W
Frequency response (-1dB)	5Hz - 50kHz
S/N ratio (ref 1W)	>92dB (unweighted)
Input impedances	47kohms
Power Amp damping factor	>100
Max. power consumption	600W
Standby power consumption	<0.5W @ rated mains
Bass/Treble controls	Shelving, ultimate boost/cut +/- 7.5dB @ 20Hz and 20kHz
USB input	USB Audio 1.0 16 bit 32kHz, 44.1kHz, 48kHz.
USB maximum current rating	500mA
Dimensions (H x W x D)	120 x 430 x 350mm (4.7 x 16.9 x 13.8")
Weight	8.4kg (18.5lbs)

Troubleshooting

There is no power

Ensure the AC power cord is connected securely.
Ensure the plug is fully inserted into the wall socket and is switched on.
Check the unit is switched on at the rear panel.
Check fuse in the mains plug or adaptor.

There is no sound

Make sure the unit is not in Standby mode.
Check that the source component is properly connected.
Check that your speakers are properly connected.
Check that the correct speaker outputs are switched on ('Speaker A/B' button on the remote control).
If source LED is flashing, turn 'Mute' off.

There is no sound on one channel

Ensure that balance control is in the correct position.
Check speaker connections.
Check interconnects.

There is a loud buzz or hum

Check turntable or tone arm for ground and connection lead fault.
Ensure no interconnects are loose or defective.
Ensure that your tape deck or turntable is not too close to the amplifier.

Unable to make tape recordings

Check that 'Rec Out' has been connected correctly.

There is weak bass or diffused stereo imaging

Ensure that speakers are not wired out of phase.

The sound is distorted

Check that the volume or tone controls are not set too high.

Protection LED flashing

See section on CAP5 protection system.

The remote handset will not function

Check that the batteries have not expired.
Ensure that nothing is blocking the remote sensor.

In the event that the above solutions do not remedy your problem, please consult our frequently asked questions (FAQ) section on our website: www.cambridge-audio.com/sts/faqs

For all servicing, in or out of warranty, please contact your dealer.

Cambridge Audio is a brand of Audio Partnership Plc
Registered Office: Gallery Court, Hankey Place
London SE1 4BB, United Kingdom
Registered in England No. 2953313

www.cambridge-audio.com

