

azur

651/751BD

 **Cambridge Audio**

Your movies + our passion

Make sure you register your purchase.

Visit: www.cambridge-audio.com/care

By registering, you'll be the first to know about:

- Future product releases
- Software upgrades
- News, events and exclusive offers plus competitions!

This guide is designed to make installing and using this product as easy as possible. Information in this document has been carefully checked for accuracy at the time of printing; however, Cambridge Audio's policy is one of continuous improvement, therefore design and specifications are subject to change without prior notice.

This document contains proprietary information protected by copyright. All rights are reserved. No part of this manual may be reproduced by any mechanical, electronic or other means, in any form, without prior written permission of the manufacturer. All trademarks and registered trademarks are the property of their respective owners.

© Copyright Cambridge Audio Ltd 2012

Manufactured under license from Dolby Laboratories. "Dolby" and the double-D symbol are trademarks of Dolby Laboratories.

Manufactured under license under U.S. Patent #'s: 5,451,942; 5,956,674; 5,974,380; 5,978,762; 6,226,616; 6,487,535; 7,392,195; 7,272,567; 7,333,929; 7,212,872 & other U.S. and worldwide patents issued & pending. DTS and the Symbol are registered trademarks, & DTS-HD, DTS-HD Master Audio | Essential and the DTS logos are trademarks of DTS, Inc. Product includes software. © DTS, Inc. All Rights Reserved.

"HDMI", "HDMI logo" and "High-Definition Multimedia Interface" are trademarks or registered trademarks of HDMI Licensing LLC.

"Blu-ray Disc", "Blu-ray", "Blu-ray 3D", "BD-Live", "BONUSVIEW", and the logos are trademarks of Blu-ray Disc Association.

Java and all Java-based trademarks and logos are trademarks or registered trademarks of Sun Microsystems, Inc. in the United States and other countries.

DVD Logo is a trademark of DVD Format/Logo Licensing Corp., registered in the U.S., Japan and other countries.

Super Audio CD, SACD and the SACD logo are joint trademarks of Sony Corporation and Philips Electronics N.V. Direct Stream Digital (DSD) is a trademark of Sony Corporation.

"AVCHD" and the "AVCHD" logo are trademarks of Panasonic Corporation and Sony Corporation.

Designed for Windows Media, Microsoft, HDCD, and the HDCD logo are trademarks or registered trademarks of Microsoft Corporation in the United States and/or other countries.

"DivX" is a trademark of DivX, Inc.

"Qdeo" and "QuietVideo" are trademarks of Marvell or its affiliates.

All other trademarks are the properties of their respective owners.

Contents

Introduction.....3

Important safety instructions4

Limited warranty6

Compatible disc types7

Rear panel connections8

Front panel controls and display9

Remote control10

Connecting to the Internet.....11

Audio connections.....12

Analogue video connections13

HDMI connections.....13

Setting up the player15

 Accessing the Easy Setup Wizard15

 Choose the primary video output.....15

 Select the best output resolution.....15

 Determine the display aspect ration.....16

 Select the audio setting.....16

Operating instructions.....17

 Picture-in-Picture and Secondary Audio18

 BD-Live.....18

 Output resolution19

 TV system selection19

Other media playback.....20

 Connecting a USB or an e-Sata Drive20

Using the Setup Menu System22

 Playback Setup.....23

 Video Setup24

 Audio Format Setup.....27

 Audio signal reference chart28

 Recommended audio format options29

 Audio Processing setup29

 Speaker Configuration30

 Other Audio Processing Settings31

 Device Setup.....31

 Network Setup.....33

 Picture Adjustment.....34

Appendix - language code list.....37

Technical specifications.....38

Troubleshooting.....39

Introduction

Thank you for purchasing this Cambridge Audio Azur Blu-ray Player. Like all Cambridge Audio products, our Blu-ray players adhere to our three core principles – stunning performance, ease of use and incredible value.

The 651BD/751BD both features almost universal disc compatibility and can play back CD, HDCD, DVD-Video, DVD-Audio, Super Audio CD and Blu-Ray discs including those with 3D content. 24/192kHz Digital to Analogue converters and our usual careful audio design ensure that the 651BD/751BD can reproduce the dynamics and scale required for modern movie soundtracks whilst also being able to reproduce a genuinely musical performance with either stereo or multi-channel music discs.

A full range of HDMI, digital and analogue outputs are fitted. These allow the connection of suitably equipped TVs and AV receivers.

Twin HDMI outputs allow two screens or a screen and a projector to be connected at the same time. Both are fully compatible with the HDMI 1.4 standard for 3D TV and deepcolour support.

The primary output also features a Marvell QDEO scaler with motion adaptive noise reduction and a host of technologies to further improve the picture quality for this output.

An Ethernet connection is provided for BD Live and other interactive features via the internet. Additionally the 751BD is supplied with a USB Wi-Fi dongle.

The latest surround-sound formats are supported including decoding of Dolby True HD, Dolby Digital Plus, DTS-HD Master Audio and DTS-HD High Resolution Audio in Stereo, 5.1 or 7.1 variants. In particular support for the true lossless Dolby True HD and DTS HD Master Audio formats provides unprecedented audio fidelity from Blu-ray discs.

The 651BD/751BD is also capable of outputting all of these formats as bitstreams over HDMI for decoding in a suitable AV Receiver.

Both models use 24/192kHz Digital to Analogue converters. The 651BD features a Cirrus Logic CS4382A 8 Channel multi-dac to create its 7.1 analog output (which can be set to Stereo mode also).

The 751BD instead uses five WM8740 stereo DACs from Wolfson Microelectronics and features both a permanent 7.1 and a separate Stereo output. For the 751BD all analog outputs are also up-sampled via an Analog Devices DSP running our proprietary Q5 Upsampling and jitter suppression algorithm from Anagram Technologies to 24 bits and 192kHz.

Both models feature an environmentally friendly low power (1W) standby circuit.

All this proprietary engineering is housed within our low resonance, acoustically damped chassis. An Azur Navigator remote control is also provided, giving full remote control of your Blu-ray player and if required a Cambridge Audio amplifier or AV receiver in an attractive and easy to use handset.

Remember your 651BD/751BD can only be as good as the system it is connected to. Please do not compromise on your AV receiver or speaker package and always use good quality video and audio cabling. Naturally we particularly recommend AV receivers such as those from the Cambridge Audio Azur range, which has been designed to the same exacting standards as this product. Your dealer can also supply excellent quality Cambridge Audio interconnects to ensure your system realises its full potential.

Thank you for taking the time to read this manual; we recommend you keep it for future reference.



Matthew Bramble
Cambridge Audio Technical Director
and the 651BD/751BD design team

Important safety instructions

For your own safety please read the following important safety instructions carefully before attempting to connect this unit to the mains power supply. They will also enable you to get the best performance from and prolong the life of the unit:

1. Read these instructions.
2. Keep these instructions.
3. Heed all warnings.
4. Follow all instructions.
5. Do not use this apparatus near water.
6. Clean only with a dry cloth.
7. Do not block any ventilation openings. Install in accordance with the manufacturer's instructions.
8. Do not install near any heat sources such as radiators, heat registers, stoves, or other apparatus (including amplifiers) that produce heat.
9. Do not defeat the safety purpose of the polarized or grounding-type plug. A polarized plug has two blades with one wider than the other. A grounding-type plug has two blades and a third grounding prong. The wide blade or the third prong are provided for your safety. If the provided plug does not fit into your outlet, consult an electrician for replacement of the obsolete outlet.
10. Protect the power cord from being walked on or pinched, particularly at plugs, convenience receptacles and the point where they exit from the apparatus.
11. Only use attachments/accessories specified by the manufacturer.
12. Use with only the cart, stand, tripod, bracket, or table specified by the manufacturer, or sold with the apparatus. When a cart is used, use caution when moving the cart/apparatus combination to avoid injury from tip-over. 
13. Unplug this apparatus during lightning storms or when unused for long periods of time.
14. Refer all servicing to qualified service personnel. Servicing is required when the apparatus has been damaged in any way, such as the power-supply cord or plug having been damaged, liquid has been spilled or objects have fallen into the apparatus, the apparatus has been exposed to rain or moisture, does not operate normally, or has been dropped.

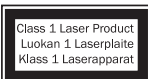

This product utilises a Laser. Use of controls or adjustments or performance of procedures other than those specified herein may result in hazardous radiation exposure. Do not open covers and do not repair yourself. Refer servicing to qualified personnel.



This label is located on the laser protective housing inside the product.

WARNING

- To reduce the risk of fire or electric shock, do not expose this unit to rain or moisture.
- Batteries (battery pack or batteries installed) shall not be exposed to excessive heat such as sunshine, fire or the like.

The unit must be installed in a manner that makes disconnection of the mains plug from the mains socket outlet (or appliance connector from the rear of the unit) possible. Where the mains plug is used as the disconnect device, the disconnect device shall remain readily operable. Only use the mains cord supplied with this unit.

Please ensure there is ample ventilation (at least 10cm clearance all round). Do not put any objects on top of this unit. Do not situate it on a rug or other soft surface and do not obstruct any air inlets or outlet grilles. Do not cover the ventilation grilles with items such as newspapers, tablecloths, curtains, etc.

This unit must not be used near water or exposed to dripping or splashing water or other liquids. No objects filled with liquid, such as vases, shall be placed on the unit.



CAUTION
Risk of electric shock.
Do not open.

AVIS
Risque de choc électrique.
Ne pas ouvrir.

ACHTUNG
Vorm öffnen des Gerätes.
Netzstecker ziehen.



The lightning flash with the arrowhead symbol within an equilateral triangle is intended to alert the user to the presence of un-insulated 'dangerous voltage' within the product's enclosure that may be of sufficient magnitude to constitute a risk of electric shock to persons.

The exclamation point within an equilateral triangle is intended to alert the user to the presence of important operating and maintenance instructions in the service literature relevant to this appliance.



The symbol on this product indicates that it is of CLASS II (double insulated) construction.



WEEE symbol

The crossed-out wheeled bin is the European Union symbol for indicating separate collection for electrical and electronic equipment. This product contains electrical and electronic equipment which should be reused, recycled or recovered and should not be disposed of with unsorted regular waste. Please return the unit or contact the authorised dealer from whom you purchased this product for more information.



CE mark

This product complies with European Low Voltage (2006/95/EC), Electromagnetic Compatibility (2004/108/EC) and Environmentally-friendly design of Energy-related Products (2009/125/EC) Directives when used and installed according to this instruction manual. For continued compliance only Cambridge Audio accessories should be used with this product and servicing must be referred to qualified service personnel.



C-Tick mark

This product meets the Australian Communications Authority's Radio communications and EMC requirements.



Gost-R Mark

This product meets Russian electronic safety approvals.

Ventilation

IMPORTANT – The unit will become hot when in use. Do not stack multiple units on top of each other. Do not place in an enclosed area such as a bookcase or in a cabinet without sufficient ventilation.

Ensure that small objects do not fall through any ventilation grille. If this happens, switch off immediately, disconnect from the mains supply and contact your dealer for advice.

Positioning

Choose the installation location carefully. Avoid placing it in direct sunlight or close to a source of heat. No naked flame sources, such as lighted candles, should be placed on the unit. Also avoid locations subject to vibration and excessive dust, cold or moisture. The unit can be used in a moderate climate.

This unit must be installed on a sturdy, level surface. Do not place in a sealed area such as a bookcase or in a cabinet. Do not place the unit on an unstable surface or shelf. The unit may fall, causing serious injury to a child or adult as well as serious damage to the product. Do not place other equipment on top of the unit.

Due to stray magnetic fields, turntables or CRT TVs should not be located nearby due to possible interference.

Electronic audio components have a running in period of around a week (if used several hours per day). This will allow the new components to settle down and the sonic properties will improve over this time.

Power sources

The unit should be operated only from the type of power source indicated on the marking label. If you are not sure of the type of power-supply to your home, consult your product dealer or local power company.

This unit can be left in Standby mode when not in use and will draw <1W in this state. To turn the unit off, unplug it from the mains socket.

Overloading

Do not overload wall outlets or extension cords as this can result in a risk of fire or electric shock. Overloaded AC outlets, extension cords, frayed power cords, damaged or cracked wire insulation and broken plugs are dangerous. They may result in a shock or fire hazard.

Be sure to insert each power cord securely. To prevent hum and noise, do not bundle the interconnect leads with the power cord or speaker leads.

Cleaning

To clean the unit, wipe its case with a dry, lint-free cloth. Do not use any cleaning fluids containing alcohol, ammonia or abrasives. Do not spray an aerosol at or near the unit.

Battery disposal

Please dispose of any discharged batteries according to local environmental/electronic waste disposal guidelines.

Connections

Before making any connections, make sure all power is turned off and only use suitable interconnects.

Servicing

These units are not user serviceable. Never attempt to repair, disassemble or reconstruct the unit if there seems to be a problem. A serious electric shock could result if this precautionary measure is ignored. In the event of a problem or failure, please contact your dealer.

Wi-Fi information

FCC Statement

DECLARATION OF CONFORMITY WITH FCC RULES FOR ELECTROMAGNETIC COMPATIBILITY

We, Cambridge Audio, of Gallery Court, Hankey Place, London SE1 4BB, declare under our sole responsibility that this device,

azur 651/751BD with Wi-Fi dongle

to which this declaration relates, complies with Part 15 of the FCC Rules. Operation is subject to the following two conditions: (1) this device may not cause harmful interference, and (2) this device must accept any interference received, including interference that may cause undesired operation.

Caution: Exposure to Radio Frequency Radiation.

The device shall be used in such a manner that the potential for human contact during normal operation is minimized.

When connecting an external antenna to the device, the antenna shall be placed in such a manner to minimize the potential for human contact during normal operation. This transmitter must not be co-located or operating in conjunction with any other antenna or transmitter.

Federal Communications Commission Notice

This equipment has been tested and found to comply with the limits for a Class B digital device, pursuant to Part 15 of the FCC Rules. These limits are designed to provide reasonable protection against harmful interference in a residential installation.

This equipment generates, uses, and can radiate radio frequency energy, and if not installed and used in accordance with the instructions, may cause harmful interference to radio communications. However, there is no guarantee that interference will not occur in a particular installation. If this equipment does cause harmful interference to radio or television reception, which can be determined by turning the equipment off and on, the user is encouraged to try and correct the interference by one or more of the following measures:

- Reorient or relocate the receiving antenna.
- Increase the distance between the equipment and the receiver.
- Connect the equipment to an outlet on a circuit different from that to which the receiver is connected.
- Consult the dealer or an experienced radio/TV technician for help.

FCC Caution: Any changes or modifications not expressly approved by the party responsible for compliance could void the user’s authority to operate this equipment.

IMPORTANT NOTE:

FCC Radiation Exposure Statement:

This equipment complies with FCC radiation exposure limits set forth for an uncontrolled environment. This equipment should be installed and operated with a minimum distance of 20cm between the radiator and your body.

This transmitter must not be co-located or operating in conjunction with any other antenna or transmitter.

2.4GHz operation of this product in the USA is firmware-limited to channels 1 through 11.

Modifications

The FCC requires the user to be notified that any changes or modifications to this device that are not expressly approved by Cambridge Audio, may void the user’s authority to operate the equipment.

Wi-Fi information

Canada-Industry Canada (IC)

The wireless radio of this device complies with RSS 210 Industry Canada. This Class B digital apparatus complies with Canadian ICES-003. Operation is subject to the following two conditions:

- 1) this device may not cause interference, and
- 2) this device must accept any interference, including interference that may cause undesired operation of the device.

IMPORTANT NOTE:

IC Radiation Exposure Statement:

This equipment complies with Canada radiation exposure limits set forth for uncontrolled environments. This equipment should be installed and operated with a minimum distance of 20cm between the radiator and your body.

This transmitter must not be co-located or operating in conjunction with any other antenna or transmitter.

Cet appareil numérique de la classe B conforme à la norme NMB-003 du Canada.

Europe-European Union Notice

Radio products with the CE 0889 or CE alert marking comply with the R&TTE Directive (1995/5/EC) issued by the Commission of the European Community.

Compliance with this directive implies conformity to the following European Norms.

- EN 60950-1 – Product Safety.
- EN 300 328 – Technical requirement for radio equipment.
- EN 301 489 – General EMC requirements for radio equipment.

To determine the type of transmitter, check the identification label on your Cambridge Audio product.

Products with the CE marking comply with European Low Voltage (2006/95/EC), Electromagnetic Compatibility (2004/108/EC) and Environmentally-friendly design of Energy-related Products (2009/125/EC) Directives issued by the Commission of the European Community. Compliance with these directives implies conformity to the following European Norms.

- EN 55022 – Electromagnetic Interference.
- EN 55024 – Electromagnetic Immunity.
- EN 61000-3-2 – Power Line Harmonics.
- EN 61000-3-3 – Power Line Flicker.
- EN 60950-1 – Product Safety Products that contain the radio transmitter are labeled with CE 0889 or CE alert marking and may also carry the CE logo.
- EN 62301:2005 - Household electrical appliances. Measurement of standby power.
- 1275/2008 - Implementing EuP Directive for Standby Power Consumption.

Limited warranty

Cambridge Audio warrants this product to be free from defects in materials and workmanship (subject to the terms set forth below). Cambridge Audio will repair or replace (at Cambridge Audio's option) this product or any defective parts in this product. Warranty periods may vary from country to country. If in doubt consult your dealer and ensure that you retain proof of purchase.

To obtain warranty service, please contact the Cambridge Audio authorised dealer from which you purchased this product. If your dealer is not equipped to perform the repair of your Cambridge Audio product, it can be returned by your dealer to Cambridge Audio or an authorised Cambridge Audio service agent. You will need to ship this product in either its original packaging or packaging affording an equal degree of protection.

Proof of purchase in the form of a bill of sale or receipted invoice, which is evidence that this product is within the warranty period, must be presented to obtain warranty service.

This warranty is invalid if (a) the factory-applied serial number has been altered or removed from this product or (b) this product was not purchased from a Cambridge Audio authorised dealer. You may call Cambridge Audio or your local country Cambridge Audio distributor to confirm that you have an unaltered serial number and/or you made a purchase from a Cambridge Audio authorised dealer.

This warranty does not cover cosmetic damage or damage due to acts of God, accident, misuse, abuse, negligence, commercial use, or modification of, or to any part of, the product. This warranty does not cover damage due to improper operation, maintenance or installation, or attempted repair by anyone other than Cambridge Audio or a Cambridge Audio dealer, or authorised service agent which is authorised to do Cambridge Audio warranty work. Any unauthorised repairs will void this warranty. This warranty does not cover products sold AS IS or WITH ALL FAULTS.

REPAIRS OR REPLACEMENTS AS PROVIDED UNDER THIS WARRANTY ARE THE EXCLUSIVE REMEDY OF THE CONSUMER. CAMBRIDGE AUDIO SHALL NOT BE LIABLE FOR ANY INCIDENTAL OR CONSEQUENTIAL DAMAGES FOR BREACH OF ANY EXPRESS OR IMPLIED WARRANTY IN THIS PRODUCT. EXCEPT TO THE EXTENT PROHIBITED BY LAW, THIS WARRANTY IS EXCLUSIVE AND IN LIEU OF ALL OTHER EXPRESS AND IMPLIED WARRANTIES WHATSOEVER INCLUDING, BUT NOT LIMITED TO, THE WARRANTY OF MERCHANTABILITY AND FITNESS FOR A PRACTICAL PURPOSE.

Some countries and US states do not allow the exclusion or limitation of incidental or consequential damages or implied warranties so the above exclusions may not apply to you. This warranty gives you specific legal rights, and you may have other statutory rights, which vary from state to state or country to country.

For any service, in or out of warranty, please contact your dealer.

Plug-fitting Instructions (UK only)

The cord supplied with this appliance is factory-fitted with a UK mains plug fitted with a 3-amp fuse inside. If it is necessary to change the fuse, it is important that a 3-amp fuse is used. If the plug needs to be changed because it is not suitable for your socket, or becomes damaged, it should be cut off and an appropriate plug fitted following the wiring instructions below. The plug must then be disposed of safely, as insertion into a mains socket is likely to cause an electrical hazard. Should it be necessary to fit a 3-pin BS mains plug to the power cord, the wires should be fitted as shown in this diagram. The colours of the wires in the mains lead of this appliance may not correspond with the coloured markings identifying the terminals in your plug. Connect them as follows:

The wire which is coloured BLUE must be connected to the terminal which is marked with the letter 'N' or coloured BLACK.

The wire which is coloured BROWN must be connected to the terminal which is marked with the letter 'L' or coloured RED.

The wire which is coloured GREEN/YELLOW must be connected to the terminal which is marked with the letter 'E' or coloured GREEN.

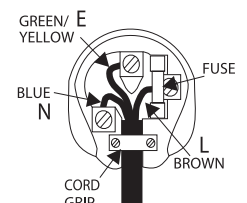

If a standard 13-amp (BS 1363) plug is used, a 3-amp fuse must be fitted or, if any other type of plug is used, a 3-amp or 5-amp fuse must be fitted, either in the plug or adaptor, or on the distribution board.

Compatible disc types



BD-Video

High Definition Blu-ray movie and music discs in BD-ROM, BD-RE and BD-R formats.



Blu-ray 3D

Discs supporting 3D Blu-ray content playback. 3D-compatible displays and active shutter glasses are required for 3D playback.

BONUS VIEW

Discs supporting BONUSVIEW that allows Virtual packages or Picture-in-Picture functions to be used.



Blu-ray Discs with interactive features when the player is connected to the Internet.



DVD-Video

DVD movie discs in DVD+RW/DVD+R/DVD-RW/DVD-R formats.



DVD-Audio

DVD format discs containing multi-channel or stereo high resolution audio of up to 24/96 5.1 or 24/192 resolution with video or still pictures. Some DVD-Audio discs also contain a DVD-Video portion.



Super Audio CD

High resolution audio-only discs with stereo and/or multi-channel audio recorded in a special bitstream format called DSD. Hybrid discs with both high resolution DSD and CD-compatible layers are supported.



Compact Disc

Compact Discs (CD-DA) and CD-R, CD-RW discs.

AVCHD

High-definition digital video camera format.



CD discs containing HDCD™ encoded material.

Discs that cannot be played

- BDs with cartridge
- DVD-RAMs
- HD DVDs
- Data portion of CD-Extras
- BD-Video/DVD-Video with a different region code to the Blu-ray player you have purchased.
- Some DualDiscs: A DualDisc is a two sided disc with DVD on one side and digital audio on the other side. The digital audio side does not generally meet the technical specifications of the Compact Disc Digital Audio (CD-DA) format so playback is not guaranteed.
- Music discs encoded with copyright protection technologies: among such discs, some again do not conform to the CD standard so playback is not guaranteed.

BD-ROM compatibility

Since the Blu-ray Disc specifications are new and evolving, some discs may not play properly depending on the disc type, version and encoding. It is possible that a Blu-ray disc manufactured after the player was manufactured uses certain new features of the Blu-ray Disc specifications. To ensure the best possible viewing experience, the player may need a firmware or software update from time to time.

Copyright protection

This product incorporates copyright protection technology that is protected by U.S. patents and other intellectual property rights. Use of this copyright protection technology must be authorized by Macrovision Corporation, and is intended for home and other limited viewing uses only unless otherwise authorized by Macrovision Corporation. Reverse engineering or disassembly is prohibited.

Region management information

This player is designed and manufactured to respond to the region management information of DVD or BD discs. If the region number of a BD-Video or DVD disc does not correspond to the region number of this player, this player cannot play the disc.

BD-Video – This player plays BD-Video with marks that match the code on the back of the unit (i.e. A, B or C).

Discs that have no region coding are also playable. These usually have all 3 region codes on the packaging in a pyramid.



DVD-Video – This player plays DVD-Video with marks that match the region code on the back of the unit (i.e. 1, 2, 3, 4 or 5).

Discs that are encoded for All regions are also playable.

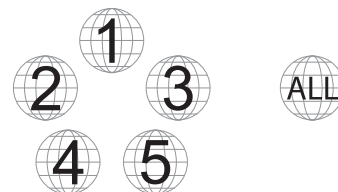

Disc care and handling

- To keep the disc clean from scratches or fingerprints, handle the disc by its edge. Do not touch the recording surface.
- Blu-ray Discs record data in very high density and the record layer is very close to the disc surface. For this reason, Blu-ray Discs are more sensitive to dust and fingerprints than DVD. Should you encounter playback problems and see dirty spots on the disc surface, clean the disc with a cleaning cloth. Wipe the disc from the centre out along the radial direction. Do not wipe the disc in a circular motion.
- Do not use record cleaning sprays or solvents such as benzene, thinner and anti-static spray.
- Do not attach labels or stickers to discs as this may cause the disc to warp, become imbalanced or too thick, resulting in playback problems.
- Avoid exposing the discs to direct sunlight or heat sources.
- Do not use the following discs:
 - Discs with exposed adhesive from removed stickers or labels. The disc may get stuck inside the player.
 - Warped or cracked discs.
 - Irregularly shaped discs, such as heart or business card shapes.

Rear panel connections

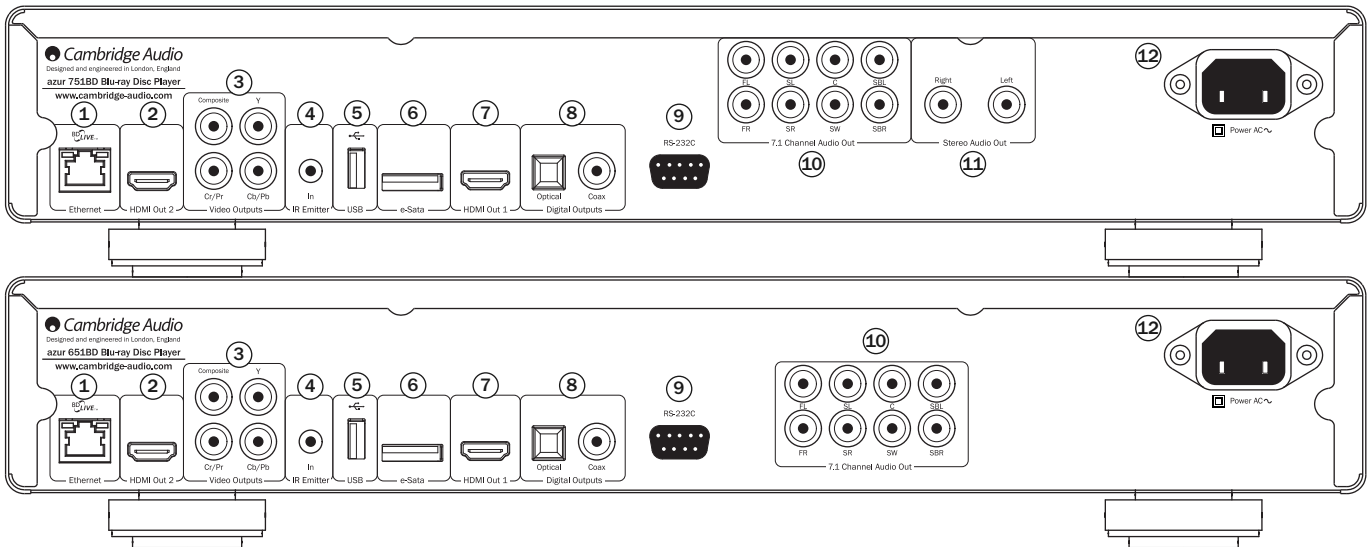

① Ethernet LAN port

Used for discs supporting BD-Live that provide interactive features when the player is connected to the Internet.

Future firmware updates may allow other online features to be accessed.

② HDMI output 2

Secondary HDMI output. Both outputs 1 and 2 can be used at the same time to send the same audio/video to two displays (with both being 3D TV compatible) or to send audio over one HDMI link and video over the other.

See later section of this manual.

③ Analogue video outputs

Component - Connect to the YCbCr or YPbPr terminals of a television set via three 75 ohm RCA/phono cables designed specifically for video use.

Composite - Connect to your television via a 75 ohms RCA/Phono cable designed specifically for video use.

④ IR (Infra-Red) Emitter In

Allows modulated IR commands from multi-room systems or IR repeater systems to be received by the unit.

⑤ USB port

Port for interfacing to a flash/memory card or Mass Storage Device.

Note:

- This unit supports USB Mass Storage Class Bulk Transport devices only. Most USB thumb drives, portable hard disk drives and card readers conform to this device class. Other USB devices such as MP3 players, digital cameras, and mobile phones that include their own memory management may not be compatible.
- Supported USB drives must be formatted with the FAT (File Allocation Table), FAT32 or NTFS (New Technology File System) file system.
- In some cases, an incompatible USB device may cause the player to stop responding. If this occurs simply turn off the power, remove the USB device, and turn the player back on.
- The player accesses the USB drive in read-only mode. In order to minimize the risk of data corruption, it is recommended that you only unplug the USB device when playback has completely stopped.

⑥ e-Sata port

For connecting a suitable hard drive.

⑦ HDMI output 1 (primary output)

HDMI (High-Definition Multi-Media Interface) is a purely digital connection that can carry both audio and video. Use a dedicated HDMI cable to connect to a TV/Monitor or AV Receiver with a compatible HDMI input.

This output is the primary output and benefits from the Marvell QDEO video processor. Both this output and output 2 are 3D TV compatible.

⑧ Digital outputs

Optical and Coaxial digital audio outputs, normally used to connect to a suitable Audio/Video Receiver for surround sound decoding (output must be set for "Bitstream" - refer to the "Audio setup" section). These outputs can also be used to connect to a separate DAC or digital recording device (output must be set for "LPCM" - refer to the "Audio setup" section).

Toslink Optical - Use a high quality TOSLINK fibre optic cable.

S/P DIF Co-Axial Digital - Use a high quality 75 ohm digital RCA/Phono interconnect cable designed specifically for digital audio use.

⑨ RS232C

Used for control of the 651/751BD in Custom Install situations. A full protocol is available for the 651/751BD on our website.

⑩ 7.1 channel analogue audio output

If Down-mix is set to "7.1 CH" in the Speaker Setup page (Down-mix mode section) of the 651/751BD's Setup menus, these sockets provide 7.1 output from the 651/751BD's built in Surround-Sound decoder. This can be used to connect to the 7.1 audio line-level inputs of an amplifier/AV receiver or amplified speaker package if required. Similarly, Down-mix can be set to "5.1 CH" to provide 5.1 output. If Down-mix is set to "LT/RT", "Stereo" or "V.Surround" the Left and Right outputs only are active and provide a stereo or stereo downmixed output. Refer to the "Speaker configuration" section of this manual for more information.

⑪ Stereo audio out (751BD only)

Permanent stereo outputs for use with Stereo material.

⑫ AC power socket

Once you have made all audio and video connections, plug the IEC type AC power cable into the rear of the unit and an appropriate mains socket then switch on. Your 651/751BD is now ready for use.

Front panel

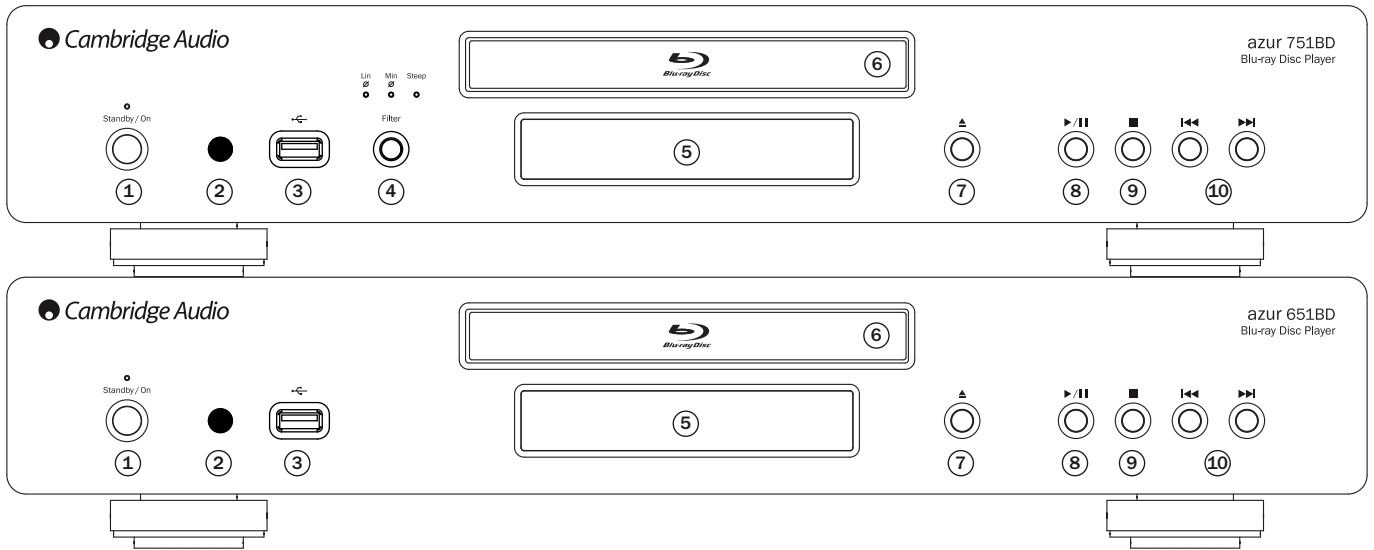

① Standby/On

Switches the unit between Standby mode (indicated by a dim power LED) and On (indicated by a bright power LED). Standby is a low power mode where the power consumption is less than 0.5W. The unit should be left in Standby mode when not in use.

② IR sensor

Receives IR commands from the supplied Azur Navigator remote control. A clear unobstructed line of sight between the remote control and the sensor is required.

③ USB port

Port for interfacing to a flash/memory card or "Mass Storage Device".

Notes:

- Only USB 2.0 certified products with the USB 2.0 logo on them are supported by the 651/751BD. Please either consult the manufacturer of the USB 2.0 product to make sure it is properly certified, or go to www.usb.org for a list of approved products. We cannot be held responsible for any incompatibility issues.
- This unit supports "USB Mass Storage Class Bulk-Only Transport" devices only. Most USB thumb drives, portable hard disk drives and card readers conform to this device class. Other USB devices such as MP3 players, digital cameras, and mobile phones may not be compatible.
- See rear USB port section for file system compatibility.

④ Filter Select (751BD only)

Press to select between three different filter audio modes: linear phase, minimum phase or steep. The corresponding LED will light up to show which filter has been selected. See later section for details.

⑤ Display

Used to display the 651/751BD's functions and playback state, etc. Please refer to the front panel display section on right for more information.

⑥ Disc tray

Use the Open/Close button to activate.

⑦ Open/Close

Allows you to open and close the disc tray for loading of discs. Pressing Play will also close the tray and start playing a disc if one is loaded.

⑧ Play/Pause

Plays the disc and pauses (freezes) playback.

⑨ Stop

Press once to stop playback. Pressing Play will cause the playback to be re-started from the same position. Press Stop again to fully stop playback.

⑩ Skip

Press once to skip between tracks/chapters.

Front panel display

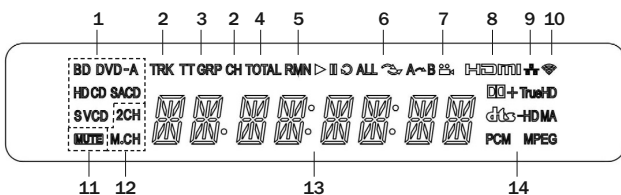

- 1. Disc Type Indication** – Indicates the currently playing disc type.
- 2. Track/Chapter** – When illuminated, the displayed time applies to a track or chapter.
- 3. Title/Group** – When illuminated, the displayed time applies to a title or group.
- 4. Total** – When illuminated, the displayed time is the total play time.
- 5. Remaining** – When illuminated, the displayed time is the remaining play time.

- 6. Playback Status** – Indicates playback status such as Play, Pause, Repeat, Repeat All, Random/Shuffle, and A-B Repeat.
- 7. Angle Icon** – Indicates that the scene contains additional camera angle(s) that can be selected.
- 8. HDMI** – Indicates that the HDMI output is active.
- 9. Network** – Indicates that the unit is connected to a network.
- 10. Wireless** – Indicates a connection to a wireless network.
- 11. Mute Icon** – Indicates that the audio is muted.
- 12. Audio Channel Indication** – Indicates whether the audio is 2ch stereo or multi-channel surround.
- 13. Main Display** – Text messages and numeric display.
- 14. Audio Type Indication** – Indicates the type of audio tracks playing.

Remote control

The Azur 651/751BD is supplied with a remote control. Insert the 3 supplied AAA batteries to activate. For further details of the various adjustment functions available, refer to the later sections of this manual.



Opens and closes the disc tray.



Switches the unit between On and Standby mode.

Info/Source

Press to show/hide the On Screen Information Display. Press and Hold to go to the Source Selection menu.

0-9 Numerical buttons

Used to enter numeric values such as the number of a desired chapter or track to go to.

Page ▲ / Page ▼

Show previous/next page.



Press to go to the Home menu.

Go To

Press once to bring up an OSD bar showing (from left to right) Playing Status, Title, Chapter, Time Counter, Progress Indicator, and Total Time. After pressing the Go To button for the first time, the cursor will be positioned at the Time Counter. This is the "Time Search" mode. Each subsequent press of the Go To button moves the cursor from Time to Chapter to Title and back round. Use the Numerical or Navigation button to enter the hours, minutes and seconds for your specified search and press the Enter button.

Clear

Press to remove outstanding track programs.

Top Menu

Show BD top menu or DVD title menu.

Pop Up Menu

Show BD pop-up menu or DVD menu.

Setup

Press to enter the Setup menu. Please refer to the "Blu-ray player setup" section of this manual for more information.

Pure Audio

Turn video off/on.

▲ ▼ ◀ ▶ Navigation

Press the directional arrows to move around menus.

Enter

Press to accept the item/function highlighted in the menu.



Press to play or pause playback.



Press to stop current playback.



Press to return to the previous menu.

Audio/Subtitle

Press once to access alternate audio soundtracks on the disc (if available on the disc).

Press and hold to access Subtitle function. When pressed for a few seconds, the Subtitle function will cycle through available languages.



Scan forwards and backwards



Right Skip – Press once to skip forward by one track/chapter on the disc.

Left Skip – Press once to skip backward by one track/chapter on the disc.

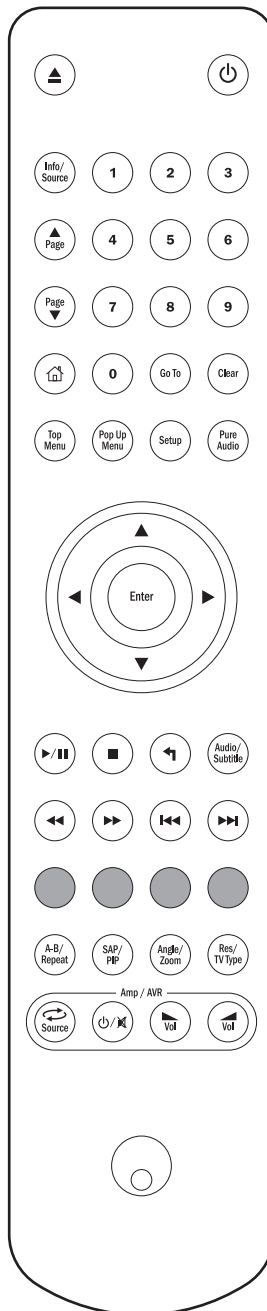

Colour buttons

These button functions vary by the content. See later section of the manual.

A-B/Repeat

Press to mark a segment between A and B for repeated playback. The first press marks point A, the second press marks point B.

Press and hold to access Repeat function. When pressed for a few seconds, the Repeat function will cycle as follows:

DVD and DVD-Audio – Repeat Chapter, Repeat Title, Repeat All, Repeat Off.

Blu-ray Disc – Repeat Chapter, Repeat Title, Repeat Off.

CD and SACD – Repeat One, Repeat All, Repeat Off.

SAP/PIP

Press to turn Secondary Audio Program on/off. Press and hold to cycle show/hide Picture-in-Picture. Refer to later section of the manual.

Angle/Zoom

Press to access various camera angles (if available on the disc). Press and hold to cycle through the various zoom magnifications (and back to normal display).

Note: These features may not be available with certain DVD or Blu-ray discs.

Res/TV Type

Press to switch output resolution. Press and hold to cycle through TV system output between PAL, NTSC or Multi. Refer to later section of this manual.

Important information if you are using a Cambridge Audio amplifier or AV receiver

Amp/AVR buttons

The 651/751BD remote also has buttons that allow control of a Cambridge Audio azur amplifier or AV receiver.

Note: These buttons are by default set to transmit codes for all current Azur AV Receivers.

The exceptions to this are the older 340R and 540R models. For these models, simply remove the batteries, leave the remote for a few minutes and then hold down the Source button whilst re-inserting the batteries.

To control an Azur stereo Amplifier, follow the same steps as above, but hold down the Standby/On/Mute button.

Source

Source Press repeatedly to scroll through the source inputs one by one.

Power/Mute Standby/On/Mute

Press to switch the amplifier/AV receiver between Standby mode and On. Press and hold to mute/un-mute the amplifier/AV receiver.

Volume

Press to decrease or increase the volume of the amplifier/AV Receiver.

Connecting to the Internet

Ethernet connection

The 651/751BD supports the BD-Live feature offered on some Blu-ray Disc titles. BD-Live offers extra downloadable content and additional online interactive programs. The available BD-Live content varies by discs and studios, and may include additional subtitles, commentaries, movie trailers, games, and/or online chat.

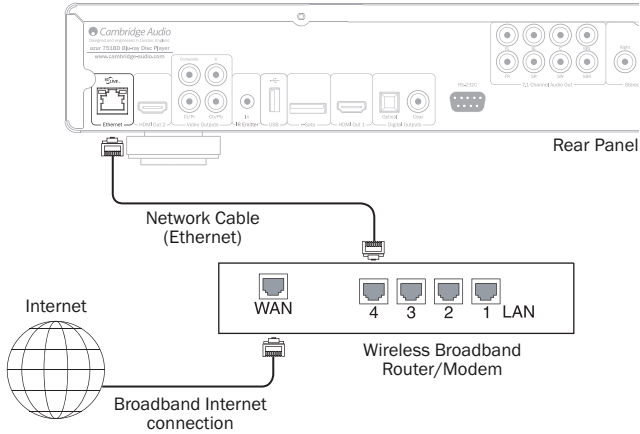

Connecting the player to the Internet will also allow the player to obtain firmware updates via the Internet.

In order to utilize the BD-Live feature or update firmware via the Internet, the player needs to be connected to a broadband Internet connection. It is not necessary to connect to the Internet if you do not intend to use the BD-Live and online firmware updating functionality.

- Plug one end of a network cable (Category 5/5E straight through Ethernet cable) into the LAN port on the back of the unit.
- Plug the other end of the network cable into a LAN port on your broadband router or modem.
- Some network configuration may be required. Please refer to the Network Setup section of the manual for more details.
- Refer to the operating instructions supplied with the broadband router or modem, or contact the Internet service provider for questions related to setting up of a router or modem.

Note: Only connect the LAN port of the player to an Ethernet port that supports 10BASE-T or 100BASE-TX. Connecting to any other ports or jacks, such as a phone jack, can damage the player.

Using the wireless adaptor (751BD only)

The wireless adaptor included with the 751BD has been pre-configured to work with your player. Other wireless adaptors will not work.

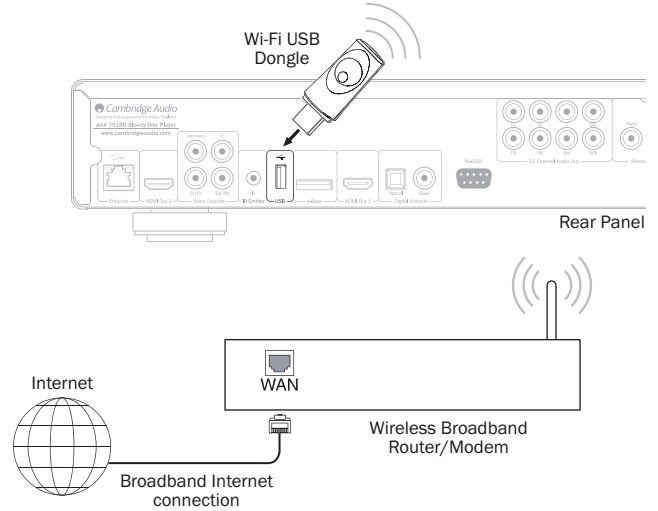

A USB extension cable is provided with your 751BD. This can be used if desired to move the wireless dongle to a more convenient location.

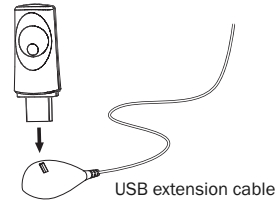

- Make sure the broadband Internet connection is available and the Wi-Fi function on your wireless router or access point has been turned on, and plug the adaptor into the rear USB 2.0 port of your 751BD.
- After connecting the adaptor, some network configuration is required. Please refer to the 'Network Setup' section of this manual.

Audio connections

Do not plug in the mains power lead or turn the unit on until all connections have been made.

Three types (two for 651BD) of audio only connection can be made between the 751BD and your stereo/AV system:

Note: It is also possible to make an HDMI audio/video connection which carries both audio and video in the same cable. See later section.

However, when making an HDMI connection i.e. to an AV receiver, it is also often preferable to make an additional audio connection for CD and/or SACD/DVD-A playback.

- ① Separate Analogue Stereo (751BD only)
- ② Digital Audio
- ③ Analogue 2 ch/5.1/7.1

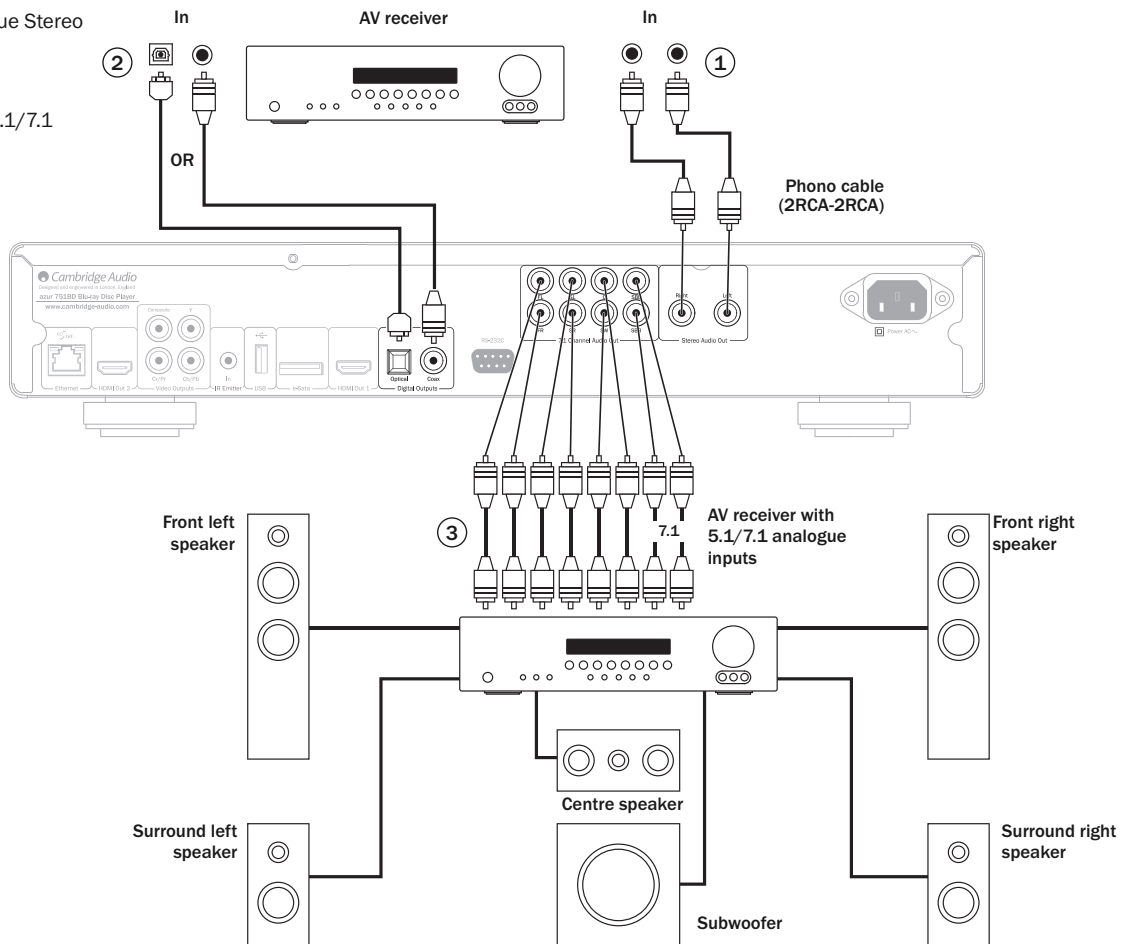

Speaker diagram shown for 5.1 channel setup. For 7.1 add two rear speakers.

① Separate analogue stereo (751BD only)

The analogue stereo outputs should be used for playback of CDs, DVDs etc in stereo through a conventional amplifier or AV receiver with analogue stereo inputs.

Analogue stereo is also usually the best connection method for listening to CDs and other stereo discs for best possible sound quality. It is often a good idea to connect both the analogue stereo outputs (for CD playback) and digital audio outputs or HDMI (for surround sound decoding) at the same time.

To connect an analogue stereo system to the 751BD, use stereo phono cables (stereo 2RCA-2RCA).

② Digital audio

The digital audio outputs should be used to decode the surround-sound soundtracks of BD/DVDs with an external AV Receiver (Note: Digital output must be set to "RAW" in the Audio setup page). The 651/751BD sends an undecoded audio bitstream to the AV Receiver for decoding into 5.1/7.1 etc.

Note: The latest HD audio types, SACD and DVD-A cannot be output over SPDIF/TOSlink and an HDMI connection must be used for these.

Either a 75ohm co-axial cable designed for digital audio or a TOSlink fibre optic cable should be used (only one at a time).

Note: It is also possible to output stereo digital audio from the Digital Outputs for recording on conventional CD-R/MD etc. machines, see section on 651/751BD setup.

③ Analogue 2 ch/5.1/7.1

The 651/751BD is also capable of decoding Surround-Sound soundtracks itself and outputting these as analogue Stereo, 5.1 or 7.1 depending on the settings in the Speaker setup page in the 651/751BD setup menu.

For 5.1, connect to an AV receiver or amplified speaker system, use 6 x phono/RCA cables.

For 7.1, connect to an AV receiver or amplified speaker system, use 8 x phono/RCA cables.

Analogue video connections

The 651/751BD can output video in both fully digital (HDMI) and analogue (Composite or Component) formats. If your TV set supports HDMI then this is the preferred format (see next section).

If your TV set supports only analogue video the preferred connection is (in declining order of quality) Component and then Composite.

Set the Primary Output option in the setup menu to 'Analog', see later section.

Note: The 651/751BD will output BD content (including 1080p) as up to 1080i over the component connections only.

Also note video up-conversion of content over the component connections is limited by CSS encryption on most discs.

The HDCP protected HDMI outputs do not suffer this limitation and offer full up-conversion of all content.

- ① Component - Connect with 75 ohm Component video cables (3RCA-3RCA).
- ② Composite - Connect with single 75 ohm video phono cable (RCA-RCA).

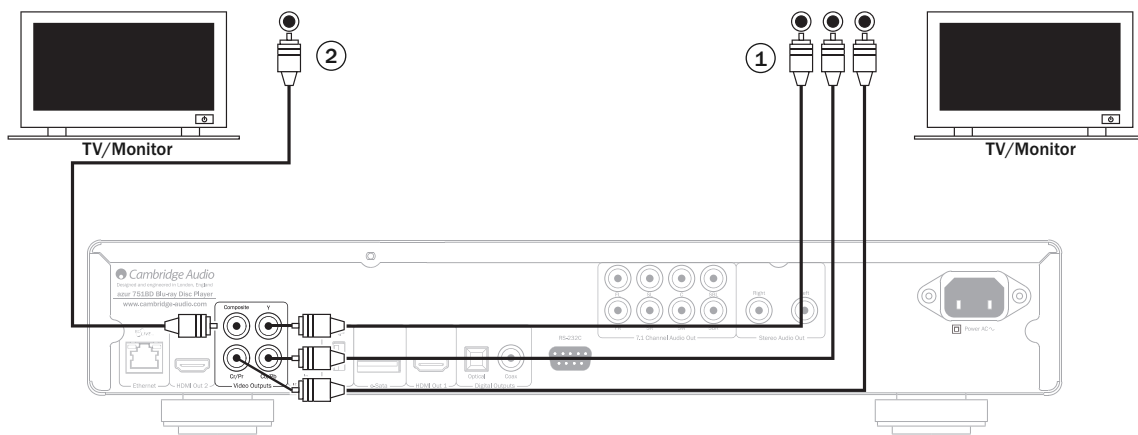

HDMI connections

HDMI (High-Definition Multi-Media Interface) is a digital connection that can carry both audio and video in one cable. Direct digital transfer of video and support for various types of high definition video content make this the best connection type for picture quality.

The 651/751BD supports two HDMI outputs, both are 3D TV compatible. For normal use with a single TV or TV and AV Receiver use HDMI output 1 (Primary Output) as this benefits from the Marvell QDEO Video processor, as shown below.

Set the Primary Output option in the setup menu to 'HDMI 1', see later section.

Note: The Dolby Digital Plus, Dolby True HD, DTS HD High Resolution and DTS HD Master Audio can only be passed by the 651/751BD over HDMI.

As HDMI can carry both digital audio and video, HDMI can be used to connect to AV receivers that support this function for external decoding.

- Ⓐ Direct connection to a TV for HDMI 1
- Ⓑ Connection to a TV via an AV Receiver for HDMI 1.

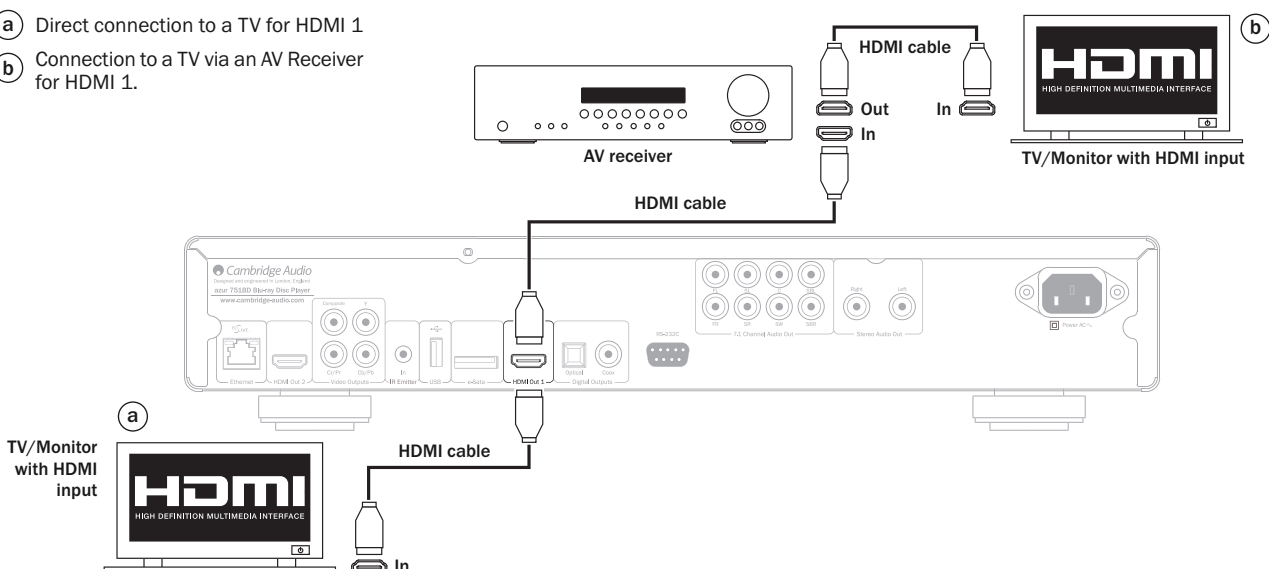

HDMI connection cont.

The secondary HDMI output of the 651/751BD can be used either to allow connection of two display devices or to allow separate HDMI audio and video outputs as shown in the two examples below.

Connecting to two displays using dual HDMI

The 651/751BD features two HDMI outputs.

It is therefore possible to connect two TVs or a TV and Projector etc. you should treat output 1 as the Primary highest quality output as it benefits from the in-built Marvell QDeo scaler.

Both outputs can pass 3D TV signals.

Set the Primary Output option in the setup menu to 'HDMI 2', see later section.

This is necessary to allow HDMI 2 to output high resolution audio.

- (a) Connection to a Primary TV/Monitor.
- (b) Connection to a Secondary TV/Monitor.

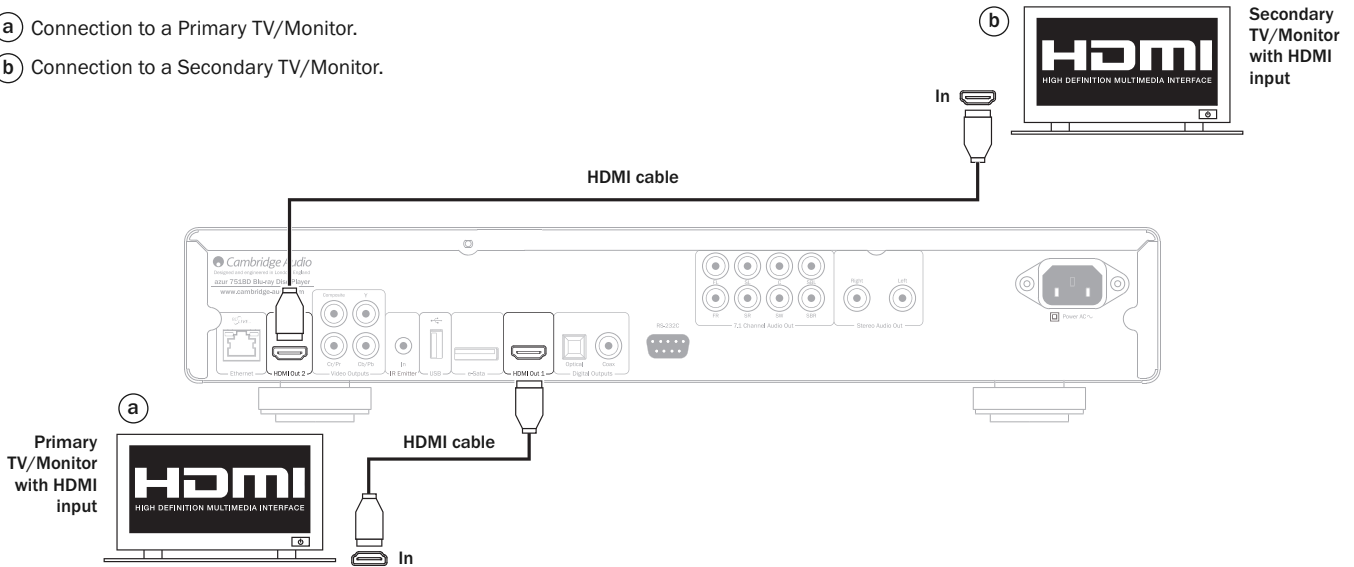

Connecting to a display and audio system using dual HDMI

If your AV Receiver cannot pass 3D TV HDMI signals it is possible to configure the 651/751BD to output Video (inc 3D TV) via HDMI 1 directly to a 3D compatible display and Audio via HDMI 2 directly to the AV Receiver.

Set the Primary Output option in the setup menu to 'HDMI 1', see later section.

- (a) Connection to a TV/Monitor.
- (b) Connection to an AV Receiver.

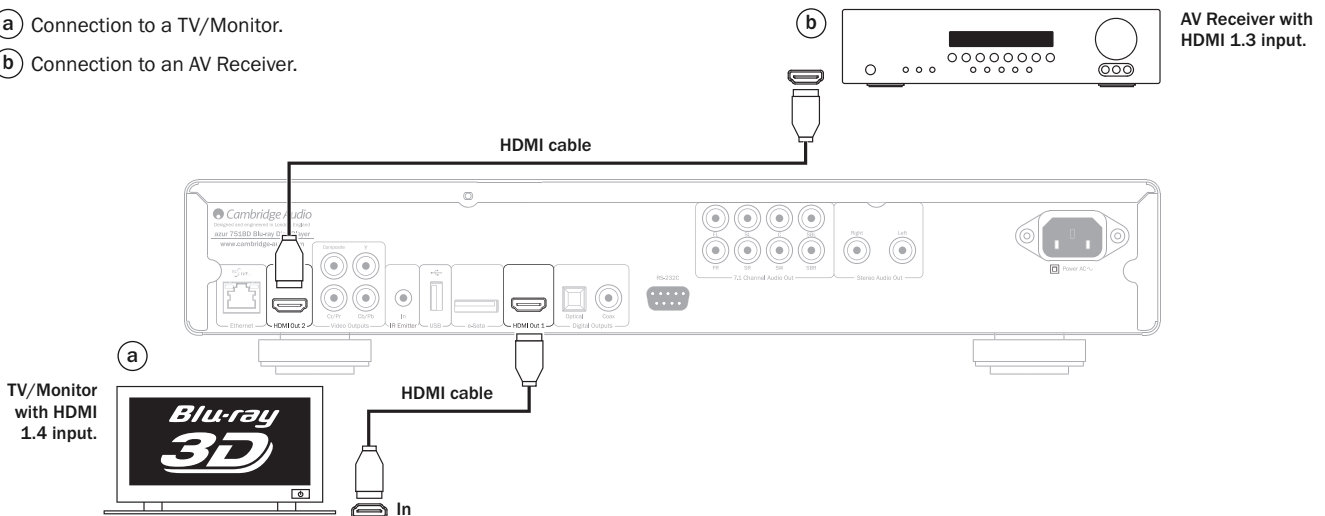

Setting up the player

Accessing the Easy Setup Wizard

When the player is turned on for the first time, an Easy Setup Wizard screen will appear. This is a series of guided instructions designed to configure the basic settings for the unit.

Note: If the Easy Setup Wizard has previously been completed or cancelled, it will no longer initiate when you turn on the unit. To access Easy Setup Wizard again, press the *Setup* button on the remote control, select Device Setup, then Reset Factory Default. Select "OK" to confirm loading the factory default settings. Once the factory default settings are loaded the Easy Setup Wizard will appear again.

To start the Easy Setup Wizard, please follow these steps:

1. Turn on the TV.
2. Turn on the player.
3. Switch the input selection on your TV so that the TV displays the signal from the player. You should see the first step of the Easy Setup Wizard.

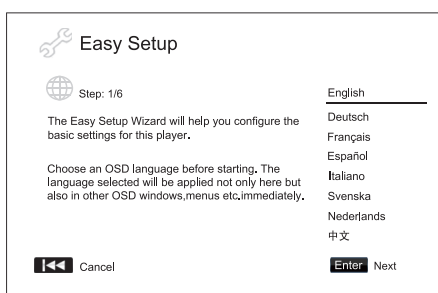

The first step of the Easy Setup Wizard gives you the opportunity to skip the entire wizard. If you are familiar with setting up audio/video equipment and would like to fully customize the player settings using its setup menu, you may use the **Left Arrow** button to select the "Cancel" option, then press the Enter button to exit the Easy Setup Wizard. Use the **Up/Down Arrow** buttons to select the language, then press Enter button to continue with the Easy Setup Wizard.

Choose the primary video output

The player can output video through its HDMI and component output terminals. Composite video output is always available but not recommended. By setting the "Primary Video Output" option, the player can optimize video output of the selected terminal. The choices are "HDMI 1", "HDMI 2" and "Analog". If you connect the player to the TV using an HDMI cable, please select "HDMI 1" or "HDMI 2" correspondingly. If you connect the player to the TV using component video cables, please select "Analog".

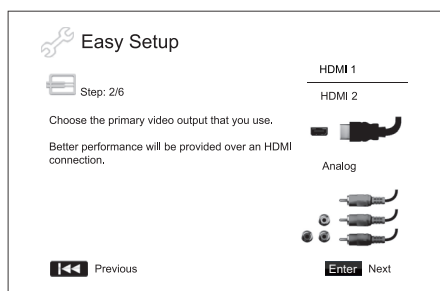

Note: The best performance will be provided over the HDMI connection. Between the two HDMI outputs, HDMI 1 should be given priority for use since it benefits from the superior Marvell QDEO video processing solution.

To make your selection, use the **Up/Down Arrow** buttons to highlight the choice, and then press the Enter button to go to the next

Select the best output resolution

For the latest generation of 1080p, "Full HD" or "True HD" TV displays, the best output resolution will naturally be 1080p. For all other digital televisions this will likely be 720p or 1080i. These are general recommendations that work for most users, but there can be exceptions. Advanced users may want to try all supported resolutions and choose the one that provides the best visual result.

The 651/751BD supports a special "Source Direct" output resolution on its HDMI output. This resolution is recommended for use with external video processors or high-end TVs with high quality scalars. In "Source Direct" mode, the player works as a "transport". It decodes video from the discs and then sends the raw video signal in its native resolution and format, without extra processing, to the external video processor or TV. The actual output resolution thus varies by content:

Content	Source Direct Output Resolution
PAL DVD	576i
NTSC DVD	480i
Most Blu-ray Movies (film-source)	1080p 23.976Hz or 1080p 24Hz
Most Blu-ray TV shows or Concerts (video-source)	1080i
SACD and DVD-Audio	1080i

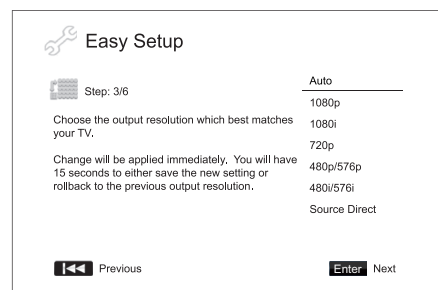

Depending on your selection of "Primary Video Output", the available output resolution selections will differ. For the HDMI 1 and HDMI 2 output, the following output resolutions are available:

Auto, 1080p, 1080i, 720p, 480p/576p, 480i/576i, and Source Direct. If "Auto" is selected, the player will determine its output resolution based on the best signal resolution that the TV can display.

For the Analog (component) output, the following output resolutions are available: 1080p, 1080i, 720p, 480p/576p and 480i/576i.

Note: 1080p only applies to HDMI output, if it is selected for component video outputs, it will automatically be down-scaled to 1080i. Please refer to the specifications of your TV to find the best resolution to use.

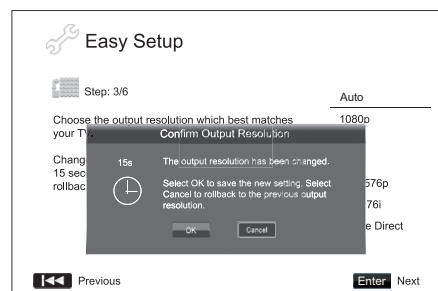

Press the **Up/Down Arrow** buttons to select the desired output resolution, then press the Enter button. The player will apply the selected output resolution and ask you to confirm the selection. If your TV supports the selected resolution, you will see a dialog box with a countdown clock. Use the **Left Arrow** button to highlight the "OK" option and press the Enter button to save the resolution setting. If your TV does not support the selected resolution, you may see a black screen or an error message. In this case please wait for 15 seconds and the Easy Setup screen will reappear. Select a different resolution that your TV can support.

Setting up the player cont.

Note:

- In case you are not able to get a picture using the HDMI or component output, please connect the player to the TV using the composite video output, and then use the Setup Menu to adjust the player settings.
- Video up-conversion over the component output is only available for unencrypted discs such as home video and consumer-created contents. Most commercially pressed DVD discs are CSS-encrypted and will be limited to 480i/480p resolution. This restriction applies to the component output only. The HDMI output is protected with HDCP and has no such restriction.

Determine the display aspect ratio

Use to select the screen format to fit your TV screen.

4:3 Letterbox - Alternatively you can select this screen when connected to a 4:3 TV set. The full widescreen picture is displayed on the screen with black strips on the top and bottom of the screen.



4:3 PanScan - You can select this screen when connected to a 4:3 TV set. The widescreen picture will display on the full screen, but some parts of the video picture will be cut off automatically.



16:9 Wide - Select this screen when connected to a 16:9 widescreen TV set. The full picture will now normally be displayed with no picture cropping (unless the movie itself has black bars recorded into the video).



16:9 Wide/Auto - 16:9 (widescreen) as well as 4:3 sources will be displayed in their native aspect ratio. Please note that in this mode 4:3 sources will be displayed with black borders on both sides to maintain the correct 4:3 aspect ratio.

Note: If you are using a plasma or widescreen CRT display you will want to avoid leaving black bars on the screen for any length of time as you may encounter temporary "burn-in" where the display retains memory of the "used" part of screen and the unused (black bar) portions are clearly defined on the screen during subsequent viewing sessions. The "16:9 Wide" mode is the best choice for these types of displays.

Press the **▲ ▼** buttons to select the proper aspect ratio for your TV, then press the Enter button.

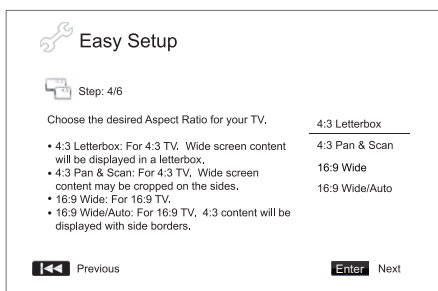

Select the audio setting

The Blu-ray disc format brings not only high resolution video, but also high bit rate audio such as Dolby Digital Plus, Dolby TrueHD, DTS-HD High Resolution and DTS-HD Master Audio. Blu-ray Discs may also include additional audio features such as menu click sound and Secondary Audio Program (SAP – audio associated with the secondary video in Picture-in-Picture mode). Depending on the user preferences and other audio/video equipment connected to the player, the audio settings need to be adjusted to achieve the best result. The Easy Setup Wizard offers two basic selections to get you started.

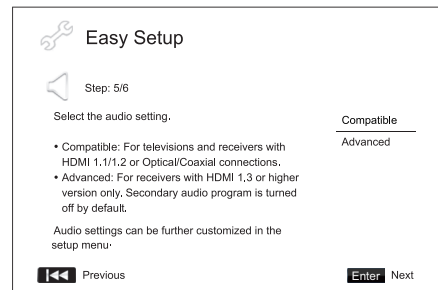

The "Compatible" setting configures audio output in a way that is generally compatible with all types of equipment and content. If you connect the player to a television directly, or to a receiver with an HDMI 1.1/1.2 or optical/coaxial input, selecting the "Compatible" setting is recommended. When menu click sound and Secondary Audio Program are presented in the content, those will be mixed into the audio output.

The "Advanced" setting configures audio output to send the original main audio content to a connected receiver for decoding and reproducing. It requires a receiver capable of decoding all high bit rate audio formats. If you connect the player to a receiver supporting HDMI 1.3 and high bit rate audio formats (such as our 650R AV Receiver), selecting the "Advanced" setting is recommended. Menu click sound and Secondary Audio Program are turned off by default to preserve the original quality of the main audio content.

Press the **▲ ▼** buttons to select one of the audio setting choices, and then press the Enter button. The two basic audio setting choices may not cover all situations. You can further customize the audio settings using the player's Setup Menu.

Complete the Easy Setup Wizard

Once you have selected the audio setting, the initial Easy Setup Wizard is completed.

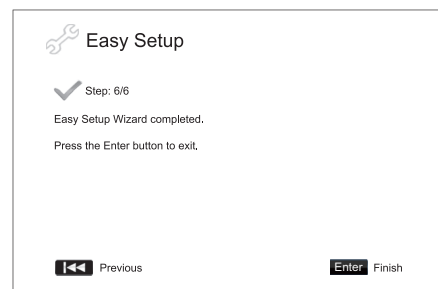

Press the Enter button to close the Easy Setup Wizard. Your player is now ready for use. You will see a background screen with a Cambridge Audio and Blu-ray Disc logo. Please follow the rest of the user manual for basic and advanced operations.

Operating instructions

Getting started

Turn on the power of the 651/751BD, TV, amplifier/AV receiver and any other components which are connected to the 651/751BD. Make sure the TV and the audio receiver are set to the correct input channel.

1. Press the Open/Close button to open the disc tray.
2. Place the disc on the tray, label side facing up.
3. The player will read the disc information and starts playback.
4. Depending on the content of the disc, a menu or navigation screen may appear. Please use the (▲▼◀▶) navigation and Enter button to select the content to play.
5. To stop playback, press the ■ button.
6. To turn off the player, press the Standby/On button.

Note:

- During DVD and some Blu-ray Disc playback, pressing the ■ button for the first time brings the player to a pre-stop mode. You can resume playback from the stopped point by pressing the ▶/|| button. This pre-stop mode allows you to change the player settings and then resume playback. To completely stop playback, press the ■ button twice.
- Certain Blu-ray Discs with BD-Java technology do not support the pre-stop mode. Pressing the ■ button during playback of such discs will completely stop the disc. Pressing the ▶/|| button once the disc is stopped will restart it from the very beginning.
- This unit featured an environmentally friendly low power (1W) standby circuit. If it is not to be used for a long time, unplug it from the household AC outlet.
- Do not put anything except a BD/DVD/CD sized disc into the tray, foreign objects may damage the mechanism.
- Do not force the tray by hand during the opening and closing operations.
- To avoid dirt and dust entering the mechanism, keep the disc tray closed when not in use.
- If the disc is seriously scratched or too dirty, the player may not be able to read it or play it.
- Never load more than one disc into the disc tray at one time.

Fast Forward/Rewind search

Press repeatedly to cycle between 1X, 2X, 3X, 4X and 5X playback speed (without sound) and back to normal playback. Press ◀ button for backwards playback options, or the ▶ button for forwards playback.

Note:

- Certain Blu-ray discs utilising the BD-Java technology may have their own fast forwarding and reversing control. The actual speed varies by disc, and a progress scale may be displayed by the disc.

Skip playback

1. Press ▶ once to skip forward by one track/chapter on the disc. Press and hold to skip forwards through several tracks.
2. Press ◀ once to skip backward by one track/chapter on the disc. Press and hold to skip backwards through several tracks.

Go To

Press the Go To button on the remote once to access Time Search and enter the required time from the start of the disc as H:MM:SS (Hours, Minutes, Seconds) using the numerical keys or the (▲▼◀▶) navigational buttons. Press twice to access Chapter Time Selection and enter the required time from the start of the chapter. Press three times to access the Display information.

Slow

When playing a BD/DVD, press the || button to pause playback and then press the ◀ or ▶ button to cycle round the various speeds of slow motion (1/16, 1/8, 1/4 and 1/2), forwards and backwards and back to normal speed. To exit playback, press the ▶/|| button.

Note: Certain Blu-ray discs utilising the BD-Java technology may not support slow playback.

Pause and frame by frame

1. During playback, press the ▶/|| button to temporarily pause the program. In this mode, a Pause icon will appear on the TV screen.
2. While a DVD or Blu-ray Disc is paused, press the ◀◀ or ▶▶ button to reverse or advance the video frame-by-frame.
3. Press the ▶/|| button to resume normal playback.

Repeat

Note: The Repeat function is available only during playback.

Press and hold the A-B/Repeat button to access Repeat function. When pressed for a few seconds, the Repeat function will cycle as follows:

DVD and DVD-Audio – Repeat Chapter, Repeat Title, Repeat All, Repeat Off.

Blu-ray Disc – Repeat Chapter, Repeat Title, Repeat Off.

CD and SACD – Repeat One, Repeat All, Repeat Off.

Note: The repeat chapter/title setting will be cleared when moving to other chapter or title. Certain Blu-ray discs may not allow the Repeat function.

A-B Repeat

1. Press the A-B button at your desired starting point. "A" appears briefly on the TV screen.
2. Press the A-B button at your desired end point. "A-B" appears briefly on the TV screen, and the repeat sequence begins.
3. To exit the sequence, press the A-B button.

Note:

- The A-B repeat section can only be set within the current title (for BD/DVD video) or current track (for BD/DVD audio, Video CD and Audio CD).
- A-B repeat playback is not available with some scenes on BD/DVD.
- A-B repeat playback does not function during title, chapter, track or all repeat playback.

On-Screen Display

1. During the playback of a BD/DVD disc, press the Info button on the remote control to show status information; For CD and SACD, the status information is shown automatically.
2. While the status information is shown, press the ▲▼ buttons to scroll through several display formats. The playback time information displayed on the front panel changes together with the on-screen display.
3. Press the Info button again to hide the on-screen display. The playback time information display on the front panel will remain in the selected format.

In addition to the playback time, the on-screen display may also contain the following information about the content currently playing:

Playback status – an icon indicating play, pause, and fast forward/reverse status.

Bit rate meter – an indication of the bit rate of the audio and video stream.

Current and total title numbers (DVD and Blu-ray Discs), title chapters (DVD and Blu-ray Discs) and total tracks (CD and SACD).

Audio information – current and totally available number of audio tracks, language, format, and channels.

Subtitle information – current and totally available number of subtitle tracks and language.

Video format information – encoding type, frame rate and original aspect ratio.

Operating instructions cont.

Audio language (soundtrack) selection

1. To select the audio language, press and hold the Audio/Subtitle button on the remote control during playback.
2. Repeatedly pressing the Audio/Subtitle button cycles through all available audio soundtracks on the disc.

Note: The availability of languages and audio soundtracks varies by disc. Some BD/DVD-Audio discs allow audio track selection with the Audio button, while others require the user to select from the audio setup menu of the disc. When playing a SACD with both multi-channel and stereo contents, the Audio button can be used to switch between the two formats.

Subtitle selection

1. When playing a DVD, Blu-ray disc or other video programs recorded with subtitles, press and hold the Audio/Subtitle button on the remote control to select the desired subtitle.
2. Holding down the Audio/Subtitle button will cycle through all available subtitles.
3. To turn off subtitles, hold down the Audio/Subtitle button until the subtitle is turned off.

Angle selection

1. When playing a DVD or Blu-ray Disc, an angle mark will be displayed on the screen when the player detects scenes recorded with multiple possible angles.



The angle mark is also shown on the front panel display.

2. Press and hold the Angle/Zoom button on the remote control to select the desired playing angle.
3. To resume normal playback, hold the Angle/Zoom button until the default angle is displayed.

Note: This function is available only when the discs are recorded with multiple angles. The Angle mark display shows when an alternative angle is available. The Angle mark display on the screen can be turned off using the Setup Menu of the player.

Zoom

To change the zoom level, press and hold the Angle/Zoom button on the remote control. Holding down the Angle/Zoom button will switch the zoom level in the following sequence: 2x, 3x, 4x, 1/2, 1/3, 1/4 then back to normal.

The zoom level is reset to 1:1 when the disc is ejected, or when the player is turned off.

Note: The Zoom feature may not be available when certain DVD or Blu-ray Discs are played because the disc author chooses to disable Zoom.

Blu-ray disc menu

1. Blu-ray discs usually contain a top menu and a pop-up menu. The top menu normally appears at the beginning of the playback, after the previews and copyright messages. The Pop-up Menu can be accessed during playback without interruption.
2. During playback, press the Pop-up Menu button to access the pop-up menu. Press the Top Menu button to access the top menu.
3. Navigate the menu using the (▲ ▼ ◀ ▶) Navigation buttons, and then press the Enter button to make the selection.
4. Some menus make use of the colour buttons. You can select menu functions by pressing the corresponding Colour button on the remote control.

DVD disc menu

1. Some DVD discs contain title menu or chapter menu functions.
2. During playback, press the Top Menu button to return to the disc title menu. Press the Pop-Up Menu button to display the chapter menu. Depending on the disc, one or both menus may not exist.
3. Navigate the menu using the (▲ ▼ ◀ ▶) Navigation buttons, and then press the Enter button to make the selection.
4. Press the Return button to return to the previous menu. The return location varies by disc.

Memory and automatic resume

The player automatically remembers the current position for a disc when playback is interrupted. Operations such as Open/Eject or turning Power off will cause the player to save the current playing position for that disc.

The position is memorised even after turning off the unit or changing the disc.

When the next time the same disc is played back, the player will recognize the saved playing position. Playback will automatically resume from this saved position. However if you wish to cancel the automatic resume and start playback from the beginning, you may press the ■ button when prompted.

The player can remember playback position for up to five discs. When the sixth disc is memorised, the oldest one is replaced.

Note: Some Blu-ray discs do not support resuming and will always play from the beginning.

BONUS VIEW™

Picture-in-Picture and Secondary Audio

Certain Blu-ray discs contain secondary video (Picture-in-Picture/PIP) and secondary audio. This feature is often called BONUSVIEW. When such a disc is played, a Picture-in-Picture mark (PIP Mark) and a Secondary Audio Program Mark (SAP Mark) may be displayed on the screen to alert you to the availability of the secondary audio/video content.

The disc menu usually features interactive controls to turn on/off the Picture-in-Picture video and Secondary Audio Program. Please use those controls to select the desired secondary audio/video content.

There is also a PIP button on the remote control. If the disc menu does not offer interactive Picture-in-Picture controls, please use this button to turn on/off Picture-in-Picture or select from multiple secondary video programs.

Similarly there is a SAP button on the remote control. If the disc menu does not offer interactive secondary audio controls, please use this button to turn on/off Secondary Audio Program or select from multiple secondary audio tracks. Secondary Audio Programs are generally only available when Picture-in-Picture is shown.

Note:

- This function is available only when the discs are recorded with secondary video and audio programs.
- Discs may not always be played back according to the PIP and SAP remote buttons. Certain discs can ignore or override the remote control commands.
- The PIP and SAP Marks on the screen (which alert the user to the presence of these functions on the disc) can be turned off using the Setup Menu of the player.



Some Blu-ray disc titles are released with the BD-Live feature. BD-Live offers extra downloadable contents and additional online interactive programs. The available BD-Live content varies by disc and studio, and may include additional subtitles, commentaries, preview trailers, games, and online chat. The player needs to be connected to the Internet in order to play BD-Live contents.

Depending on how the studios organise their BD-Live contents, some Blu-ray discs may start downloading BD-Live content when playback starts; some have a BD-Live selection on its main menu; some may show a prompt to ask whether you would like to start downloading; and some may ask you to sign up for a membership or account. Please follow the instructions that come with the disc to enjoy BD-Live contents.

Your Internet connection speed, the overall Internet traffic situation and the capacity of the BD-Live content servers can all affect how fast BD-Live content can be downloaded. If you encounter slow downloading or intermittent playback, please play the disc without accessing the BD-Live features, or try again at a different time.

When you use the BD-Live feature, the player or disc ID and your IP (Internet Protocol) address may be sent to the content provider via the Internet. Generally, no personally identifiable information is sent. However technologies exist to match your IP address to a certain geographical area or service provider. Your Internet service provider also has the knowledge of who is using which IP address. If the BD-Live content provider requires you to login using a membership or account, the content provider will have access to your membership or account information. Please check with your Internet service provider and the BD-Live content providers for their privacy policy.

You can also choose to restrict BD-Live access using the player's Setup Menu.

Output resolution

If you would like to change the output resolution, you may do so by pressing the Res/TV Type button on the remote control:

1. Make sure the video cable is properly connected.
2. Turn on the TV. Make sure the correct input is selected.
3. Make sure that the player is turned on. Although the output resolution can be changed "on the fly", it is recommended that you stop playback and take out the disc before changing the output resolution. Press the Res/TV Type button. A "Resolution Setting" menu appears on the TV screen. In case the TV does not support the current resolution and you cannot see the "Resolution Setting" menu, the current resolution is also displayed on the front panel.
4. Use the ▲ ▼ buttons to select the new output resolution. Pressing the Res/TV Type button cycles through the available output resolutions. The new resolution is displayed on the front panel just in case you cannot see the "Resolution Setting" menu (if it is incompatible with your TV).
5. Press the Enter button to apply the selected output resolution. Or, if you do not want to change the output resolution, press the ⏪ button.

The following output resolutions are available:

PAL output via HDMI 1 or 2 – Auto, 1080p, 1080i, 720p, 576p, 576i, Source Direct.

NTSC output via HDMI 1 or 2 – Auto, 1080p, 1080i, 720p, 480p, 480i, Source Direct.

PAL output via Analog (component) – 1080p*, 1080i, 720p, 576p, 576i.

NTSC output via Analog (component) – 1080p*, 1080i, 720p, 480p, 480i.

* *When 1080p is selected with Analog output selected as the primary video output, HDMI output resolution will be 1080p and component output resolution will be 1080i.*

Note:

- Some TV sets do not support one more output resolutions (particularly 1080p). If an incompatible output resolution is selected, you will get a blank screen or an error message. In this case please select an output resolution that is supported by the TV.
- In case you are not able to get a picture using the HDMI or component output, please connect the player to the TV using the composite video output, then use the Setup menu to adjust the player settings.
- Video up-conversion over the component output is only available for unencrypted discs such as home video and consumer-created contents. Most commercially pressed DVD discs are CSS-encrypted and will be limited to 480i/480p resolution. This restriction applies to the component output only. The HDMI output is protected with HDCP and has no such restriction.

TV system selection

The 651/751BD can be set to output all video as PAL or NTSC or output the video in the same format it was recorded in (Multi). Some TVs only support PAL or NTSC and not both so forcing the output type to one or the other can be useful.

Press and hold the Res/TV Type button on the remote control to cycle the video output to PAL, NTSC or "Multi" system. The TV screen displays the selected system name.

Some points to keep in mind:

- When the video output is set to PAL or NTSC, the player will convert the disc content if different to the selected system.
- When the video output is set to "Multi", the player will not perform system conversion and will output the video in its native format on the disc. The "Multi" mode should only be used if your TV supports both NTSC and PAL systems.
- Some TV sets only support one of the PAL or NTSC systems. If the wrong output is selected, the TV may not display a picture. In this case keep holding the Res/TV Type button until a supported system is selected.
- The output system selected with the Res/TV Type button will be remembered when the player is turned off. The output system selection can also be done by setting the "TV System" item in the "Video Setup" section of the player's Setup Menu.

Viewing pictures on DVD-Audio discs

Some DVD-Audio discs contain static pictures, such as photos of the band or narration of the album. When a DVD-Audio track is playing, you may use the Page ▲ and Page ▼ buttons to select the picture.

Note: Availability of static pictures depends on the DVD-Audio disc.

Pure Audio mode

You can enjoy higher quality audio by turning off the video processing and output. The Pure Audio mode reduces any potential interference between the video and audio signals.

1. Press the Pure Audio button on the remote control to turn off video and enter Pure Audio mode. Video output will be turned off.
2. Press the Pure Audio button again to resume video and cancel Pure Audio mode.

Note:

- Pure Audio mode is automatically cancelled when the unit is switched off or when playback is stopped.
- Since HDMI carries audio together with video, the HDMI output cannot be completely turned off. A black screen (inactive video but sync is still present) is transmitted instead to minimize any potential interference.

Shuffle

When playing a CD or SACD, press the Blue button on the remote control to activate the Shuffle and Random modes. Each press of the Blue button switches the playback mode in the following sequence: Shuffle, Random and Normal.

Other media playback

As well as normal CD's, SACD's, DVD's and BD's the 651/751BD can play some music, movies and photo files either from optical datadiscs (such as CD-R, DVD-R etc.) or external memory such as USB flash-drives/thumb-drives or e-Sata hard-drives.

Connecting a USB or an e-Sata Drive

The 651/751BD is equipped with two USB 2.0 ports, one on the front of the unit and the other on the back, and also an e-Sata port at the back. You may use either USB port to plug in a USB drive or use the e-Sata port with an e-Sata drive loaded with digital music, movies and photo files.

The USB ports are rated to provide a maximum of 5V, 1A power to the attached device. This is usually sufficient to bus power (i.e. self power) USB flash drives and flash memory card readers, but may not be sufficient for USB hard disks.

To use the e-Sata port, an external power supply is needed to power up the e-Sata drive. Note that the e-Sata port does not support "hot-plugging". To avoid damaging your e-Sata drive, always plug-in/unplug the e-Sata drive when the 651/751BD is turned off.

Note:

- This unit supports Mass Storage Class Bulk Transport devices only. Most USB thumb drives, portable hard disk drives and card readers conform to this device class. Other devices such as MP3 players, digital cameras, and mobile phones that include their own memory management may not be compatible.
- Supported USB drives must be formatted with the FAT (File Allocation Table), FAT32 or NTFS (New Technology File System) file system.
- In some cases, an incompatible device may cause the player to stop responding. If this occurs simply turn off the power, remove the device, and turn the player back on.
- The player accesses the USB drive in read-only mode. In order to minimize the risk of data corruption, it is recommended that you only unplug the USB device when playback has completely stopped.
- **DO NOT attempt to plug in a USB drive into the e-Sata port, or plug in an e-Sata drive into the USB port, as this could damage both the drive and the port.**

The Home Menu

When a drive or an optical disc stored with media files is inserted, the player presents a "Home menu" to assist you in navigating and playing the files. You can also bring up the Home menu with the  button on the remote control. The Home menu is the starting point for accessing media files.



 Cambridge Audio

Depending on what type of media files that you intend to play, you can choose from "Music", "Movie" and "Photo" categories. The "Setup Menu" selection will bring you to the player's Setup Menu just like pressing the Setup button on the remote control.

Two further menu items are provided for future features.

The Internet menu may be used in the future for online streaming audio/video services. The My Network menu may allow the 651/751BD to access content over a network via UPnP AV from suitable servers.

Both features are experimental works in progress and not guaranteed parts of the 651/751BDs functionality. See the 651/751BD support page at www.cambridgeaudio.com for the latest details on these menus and any software updates available from Cambridge Audio.

Note streaming services are usually regional so any services that may be made available will usually vary from country to country also.

Playing music files

To play digital music files stored on an optical disc or external drive, select "Music" from the Home Menu. A file browser will appear to assist you in navigating the files and folders.

The first step is to select the "Data Disc" or external device that contains the music files. The player will take a moment to read the disc and list the folders and music files.

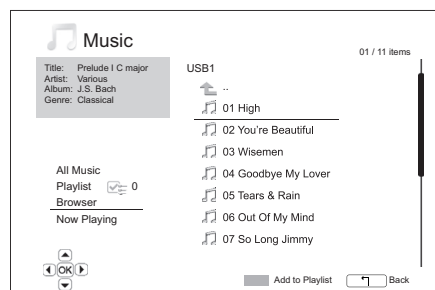
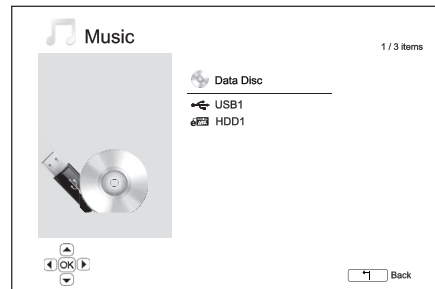

In the music browser, you can perform the following operations:

Press the   buttons or Page   buttons to move the cursor and select music files.

When a music file is highlighted by the cursor, press the Enter or  button to start playback.

Press the Green colour button to add the currently highlighted music file to the Playlist. A Green check mark will appear in front of the file name, and the Playlist count in the lower left corner of the screen will increase by one.

Press the  button to move the cursor to the selection menu in the lower left corner of the screen. This menu contains the following choices:

All Music – List all music files in a flat view without any directory structure.

Playlist – List only music files added to the Playlist.

Browser – List folders and music files according to the original directory structure on the disc or USB drive.

Now Playing – Show the status of the currently playing music file. Press the  button to move the cursor back to the file listing.

If a music file starts playing and there is no other user operation, the "Now Playing" screen will appear after a few seconds. You can also get to this screen using the "Now Playing" menu. This screen can show the following information:

Playback status –  /  ,  , 

Playback mode – Shuffle, Random, Repeat One, Repeat All

Playback progress – Track and time

Other embedded information – If the music file contains supported album art image and tags, those will be displayed.

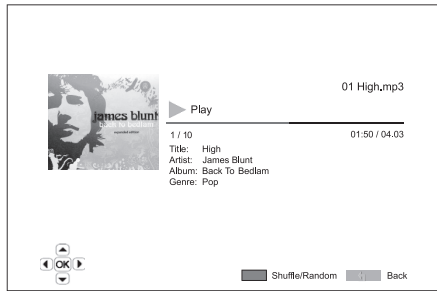

The following operations are available while the "Now Playing" screen is shown:

Normal playback control – ▶ / ⏸ , ■ , ⏮/⏭, ⏪ , and ⏩ .

Special playback mode – Repeat and Shuffle/Random (Blue colour button).

Return to the Browser without stopping the music – Return

Stop playback and return to the Browser – Press ■ twice.

Playing movie files

To play movie files stored on an optical disc or external drive, select "Movie" from the Home Menu. A file browser will appear to assist you in navigating the files and folders.

The first step is to select the "Data Disc" or external device that contains the movie files. The player will take a moment to read the disc and list the folders and movie files.

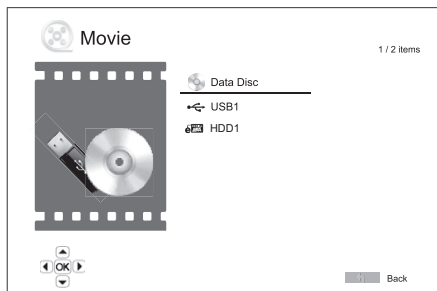

In the movie browser, you can perform the following operations:

1. Press the ▲/▼ or Page ▲/▼ buttons to move the cursor and select movie files.

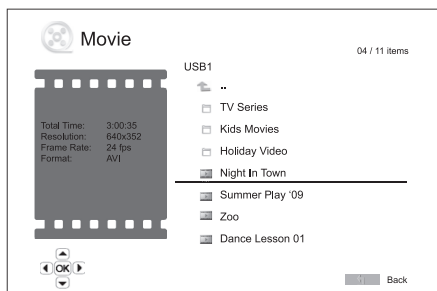

2. When a movie file is highlighted by the cursor, press the Enter or ▶ / ⏸ button to start playback.

Once a movie file starts playing, the normal playback control functions are available. To stop the movie and return to the file browser, press STOP twice. You can also press the ⏮ button at any time to get back to the Home Menu.

Viewing photo files

To view digital photo files stored on an optical disc or external drive, select "Photo" from the Home Menu. A file browser will appear to assist you in navigating the files and folders.

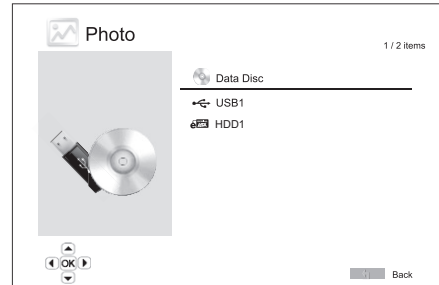

The first step is to select the "Data Disc" or USB device that contains the photo files. The player will take a moment to read the disc and list the folders and photo files.

In the photo browser, you can perform the following operations:

- Press the ▲/▼ or Page ▲/▼ buttons to move the cursor and select photo files.
- When a photo file is highlighted by the cursor, press the Enter or ▶ / ⏸ button to start playback in a full screen slideshow fashion.

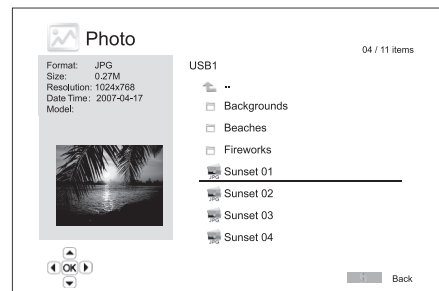

The following operations are available during the photo slideshow:

Show the help screen – Display

Normal playback control – ▶ / ⏸ and ⏮ ⏭.

Adjust slideshow speed – ⏪ and ⏩

Zoom – Zoom. Once in a zoom mode the ▲ ▼ ◀ ▶ navigational buttons can be used to pan the photo.

Reflect – ▲ button.

Mirror – ▼ button.

Rotate left (counterclockwise) – ◀ button

Rotate right (clockwise) – ▶ button

Repeat – Repeat button

Show photos in "Digest" mode – Red colour button. The "Digest" mode shows the nine photo thumbnails in a screen to make visual navigation easy.

Show EXIF information – Green colour button

Play in random/shuffle sequence – Blue colour button

Change slideshow transition effect – Yellow colour button.

Adding background music

You can add background music to the photo slideshow. To do so, you will need to prepare some digital music files. The music files can be stored on the same disk as the photos, or on a different drive. Start music playback first by selecting "Music" from the home menu. Once the music is playing, press the ⏮ button to get back to the home menu, and start the photo slideshow by selecting "Photo" in the usual manner.

Setup Menu

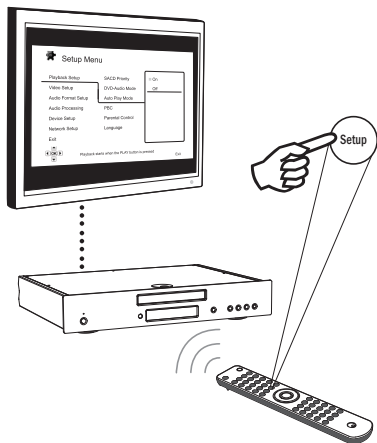

To access the player's Setup Menu simply press the Setup button on the remote control. Since some Setup Menu options can become inaccessible when the player is playing a disc, it is recommended that you operate the Setup Menu when playback is fully stopped or when there is no disc in the player.

The Setup Menu presents many setup and configuration options. For most users, the default configuration will be sufficient and will often not require changes to the settings.

However if you wish to configure the player to perfectly match your home theatre settings and viewing preferences, please refer to the following sections for details about each configuration option.

Using the Setup Menu System

When performing menu adjustments, we will use the following terminology to indicate the location of the desired function:

Setup Menu Section > Menu Item > Selection

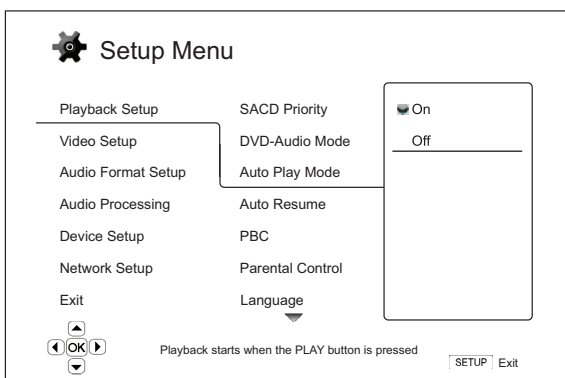

Setup Menu Section is the uppermost Setup Menu level. With the 651/751BD there are six Setup Menu sections listed in the left column of the Setup Menu screen. They are: Playback Setup, Video Setup, Audio Format Setup, Audio Processing, Device Setup, and Network Setup.

Menu Item is the parameter to be adjusted which appears in the centre column of the Setup Menu. Once you enter a Setup Menu Section, the list of Menu Items and their current value are displayed in a box.

Selection is the actual numeric or descriptive element that represents the change being made to the selected parameter. It is the item located to the right of its corresponding Menu Item.

A scroll icon appears at the top or bottom of the menu when there are more Menu Items or Selections than what can fit in a screen. You may use the **▲** and **▼** buttons to scroll the display in order to access additional items.

Note: It is possible that some setup items are greyed-out and inaccessible. This can be caused by a disc still being played back or interlocking with mutually exclusive setup items. Please stop playback or

eject the disc before trying to change these setup items. If you still cannot access the setup item, please check for configuration conflicts and consistency. For example, if "Video Setup > 1080p24 Output" is set to "Off", the "DVD 24p conversion" menu items "Auto" and "Source Direct" will be greyed-out. Setting "1080p24 Output" to "On" will enable the "DVD 24p conversion" menu items "Auto" and "Source Direct" to be set.

1. Press the Setup button on the remote control, and the TV screen displays the following:

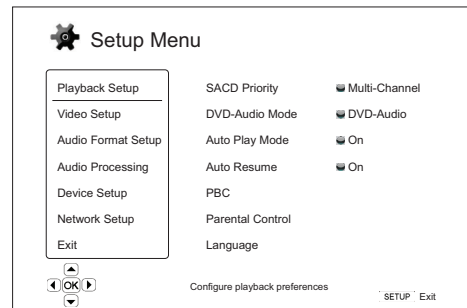

2. Press the **▲/▼** buttons to select the section. There are six sections: *Playback Setup*, *Video Setup*, *Audio Format Setup*, *Audio Processing*, *Device Setup*, and *Network Setup*. Press the Enter button or the **▶** button to enter the selected section.

3. Press the **▲/▼** buttons to select the setup item to be changed, and press the Enter or **▶** button to change the setting. When the scroll icon is shown at the top or bottom of the Setup Menu, it indicates that there are more menu items that can be accessed by scrolling with the **▲/▼** buttons.

4. To select a value from the list of available settings, press the **▲/▼** buttons and then press the Enter button to confirm. For example, to select "On" for "Auto Play Mode", use the **▲/▼** buttons to highlight the "On" selection and press the Enter button.

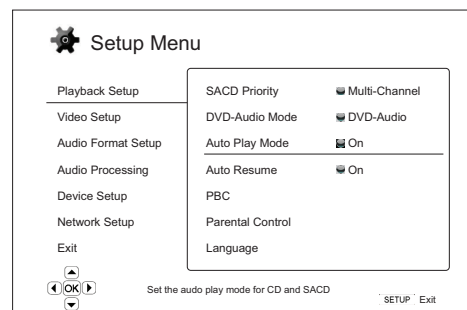

5. To exit the Setup menu at any time, press the Setup button on the remote control or select Exit from the Setup Menu sections.

The settings are permanently saved when the player is turned off using either the front panel Standby/On button or the same button on the remote control. If the AC power is interrupted before the player enters standby status, the settings will not be saved.

Playback Setup

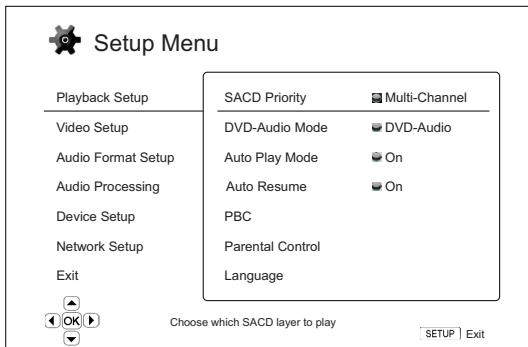

The "Playback Setup" section is designed to configure playback preferences for various contents. The setup items in this section are:

Menus	Settings
SACD Priority	Multi-Channel Stereo CD Mode
DVD-Audio Mode	DVD-Audio DVD-Video
Auto Play Mode	On Off
Auto Resume	On Off
PBC	On Off
Parental Control	BD Ratings DVD Ratings Area Code Change Password
Language	Player Language Disc Menu Language Audio Language Subtitle Language

1. SACD Priority

To select which audio layer to play by default for SACD (Super Audio CD) discs which often have multiple soundtracks. The options are:

- Multi-Channel** – Play the DSD multi-channel surround audio layer.
- Stereo** – Play the 2-channel DSD stereo audio layer.
- CD Mode** – Play the 2 channel PCM CD layer of a hybrid SACD disc.

2. DVD-Audio Mode

To select which portion of a DVD-Audio disc to play. The options are:

- DVD-Audio** – Play the DVD-Audio portion of the disc with high-resolution audio.
- DVD-Video** – Play the DVD-Video portion of the disc with Dolby Digital or DTS audio.

3. Auto Play Mode (on/off)

To select whether the player will start playing an audio CD or SACD automatically. When auto play mode is turn on, these discs will start playing upon insertion into the player. When auto play mode is turned off, the player will wait for the user to start playback by pressing the PLAY button.

4. Auto Resume (on/off)

To select whether the disc playback shall start from the previously saved point or not. This setting applies to CD, SACD, DVD and certain Blu-ray disc. When auto resume is turned on, the playback automatically starts from the previously saved point. when auto resume is turned off ,the playback starts from the beginning.

5. PBC – Play Back Control

To enable/disable Play Back Control. Play Back Control is a primitive form of disc menu. The options are:

- On** – If the disc contains Play Back Control, show the menu.
- Off** – Play back the contents by sequence.

6. Parental Control

This is used to set parental control ratings in order to prevent minors from watching inappropriate content. This function does depend on the disc being properly rated and encoded.

Press the Enter button to bring up the rating selection menu.

To adjust the parental control settings, you must enter the current parental control password. If you have not set a parental control password yet, the default password is "0000".

The parental control menu contains the following sub-items:

BD Ratings - Press the ▲/▼ buttons to select the rating allowed for Blu-ray Discs. "Off" means no ratings control and all discs are allowed to play. Numbers 1 to 21 corresponds to the age limit. Discs encoded with an age limit that is equal to or above the selected age will be allowed, and any rating below the selected age will be blocked.

DVD Ratings - Press the ▲/▼ buttons to select the rating to allow for DVD. The available ratings are Kid, G, PG, PG-13, PGR, R, NC17, Adult and Off. The selected rating and below will be allowed, and any rating above will be blocked. If "Off" is selected, all discs are allowed to play.

Area Code – Some Blu-ray Discs may have different parental control ratings for different geographical areas. At this time the player only supports the parental control ratings used in the United Kingdom.

Change Password – To change the parental control password, enter a 4-digit number as the new password. Enter the new password again to confirm. If the two entries are matching, the new password replaces the old parental control password.

7. Language

This is used to configure language preferences:

Player Language – To choose the display language for the player's Setup Menu and onscreen display.

Disc Menu Language – To choose the preferred language for displaying DVD and Blu-ray Disc menus. If a disc menu of the selected language is available, that menu will be shown instead of the default disc menu.

Audio Language – To choose the preferred audio language for DVD and Blu-ray Discs. If an audio track of the selected language is available on the disc, the Audio track will be played back.

Subtitle Language – To choose the preferred subtitle language for DVD. If a subtitle of the selected language is available on the disc, it will be displayed. When "Auto" is selected, the subtitle display is decided by the disc.

Note: If your preferred language is not listed in the Audio, Subtitle or Disc Menu options, select "Other" and enter the Language Code found on the later section of this manual.

Setup menu continued

Video Setup

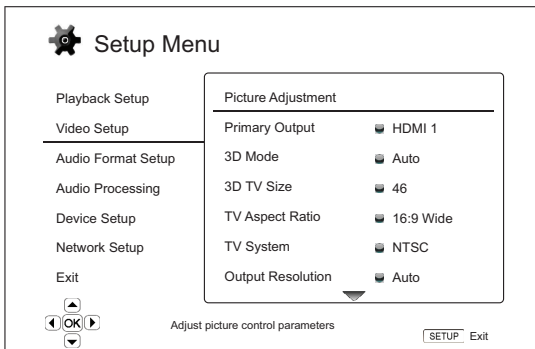

The "Video Setup" section of the Setup Menu system allows you to configure various video output options. The menu items in this section are:

Menus	Settings
Picture Adjustment	HDMI 1 HDMI 2 & Analog
Primary Output	HDMI 1 HDMI 2 Analog
3D Mode	Auto Forced Off
3D TV Size	46
TV Aspect Ratio	4:3 Letterbox 4:3 Pan & Scan 16:9 Wide 16:9 Wide/Auto
TV System	PAL (default) NTSC Multi-system
Output Resolution	Auto 1080p 1080i 720p 480p/576p 480i/576i Source Direct
1080p24 Output	Auto (default) On Off
HDMI Option	Colour Space (1&2) Auto RGB Video Level RGB PC Level YCbCr 4:4:4 YCbCr 4:2:2 Deep Colour (1&2) 36 Bits 30 Bits (Dithered) 30 Bits Off (Dithered) Off (default) Demo Mode On Off (default) Video Only Yes No (default)

Display Options	Subtitle Shift -5 to +5 OSD Position 0-5 OSD Mode Normal Silent Remaining Angle Mark On Off PIP Mark On Off SAP Mark On Off Screen Saver On Off Energy Saver
-----------------------	--

1. Picture Adjustment

This is used to adjust picture control parameters. The 651/751BD provides a wide array of picture controls. Please refer to the "Picture Adjustment" section of this manual for details of each control.

2. Primary Output

To select the primary video output method. The options are:

HDMI 1 – Use HDMI 1 as the primary video output port. This setting will ensure that the HDMI 1 output gets the best possible picture quality. The dedicated Marvell QDEO video processor will be used unless "Source Direct" for output resolution is selected, in which case the QDEO DE2750 video processor is bypassed. Component and composite video output may not be available or may be limited to a lower resolution based on content source limitations.

HDMI 2 – Use HDMI 2 as the primary video output port. Similar to "HDMI 1", this setting ensures that the HDMI 2 output gets the best possible picture quality, except that it utilizes the video decoder in the Mediatek Chipset to perform necessary video processing, not the QDEO video processor.

Analog – Use component video as the primary video output port. This setting will ensure that the component output is always available and displays proper video signals. The video decoder in the player performs any necessary format conversion, and the QDEO video processor is completely bypassed.

Note: Copyright control mechanisms encoded on the disc may limit the output resolution of the component video output. For DVD, if CSS encryption is in use the output resolution is limited to no more than 480p/576p; for Blu-ray Discs, the output resolution is limited to no more than 1080i, and could be lower if the disc contains an Image Constraint Token.

3. 3D Mode

To choose the video output mode for available 3D content at the HDMI output ports. The options are:

Auto – Output 3D if supported both by the disc content and the display. The player automatically checks for the existence of 3D content on the disc and the 3D compatibility of the TV or projector. If both are qualified, the player sends 3D video from its HDMI output terminals, otherwise only 2D video is sent out. Active shutter 3D-compatible glasses are required compatible with your TV.

Forced – Always output 3D video format for 3D Blu-ray discs. You might experience a black screen (no video output) if your TV is not 3D compatible.

Off – Always output 2D video format, even when 3D video exists on the disc. This can guarantee the video quality in case that your TV is not 3D compatible, or some necessary part (such as the 3D glasses) is missing.

4. 3D TV Size

To enter the diagonal screen size of your HDTV. This option applies to 3D mode, to facilitate the player adjusts the 3D image for better visual quality.

The diagonal size of your TV screen, by default it is 46 inches.

5. TV Aspect Ratio

To set the aspect ratio of the player's output image. The options are :

4:3 Letterbox – Choose this when the display is standard 4:3. A widescreen image is displayed in "letterbox" format with black borders on top and bottom.

4:3 Pan & Scan – Choose this when the display is standard 4:3. A widescreen image will be stretched.

16:9 Wide – Choose this when the display is widescreen 16:9. 16:9 materials will be displayed in its native aspect ratio, and 4:3 materials will be stretched horizontally.

16:9 Wide/Auto – Choose this when the display is widescreen 16:9. 16:9 materials will be displayed in its native aspect ratio, and 4:3 materials will be displayed with black borders on both sides in order to maintain the original 4:3 aspect ratio.

6. TV System

To choose the output video standard (PAL/NTSC) to match your TV. The options are:

PAL – When playing PAL-encoded discs, no system conversion is performed. NTSC-encoded contents are converted to PAL output. Blu-ray discs encoded with 24Hz frame rate are converted to 50Hz frame rate if neither 1080p24 Output nor Source Direct output resolution is enabled.

NTSC – When playing NTSC-encoded discs, no system conversion is performed. PAL encoded contents are converted to NTSC output. Blu-ray discs encoded with 24Hz frame rate are converted to 60Hz frame rate if neither 1080p24 Output nor Source Direct output resolution is enabled.

Multi-system – No system conversion is performed. The output video system is the same as that encoded on the disc. Blu-ray discs encoded with 24Hz frame rate are converted to 60Hz frame rate if neither 1080p24 Output nor Source Direct output resolution is enabled. This mode requires a TV that supports both NTSC and PAL systems.

Note: Do not select "Multi-system" if your TV does not support both PAL and NTSC systems. The TV display may become a black screen upon inserting a disc encoded in a different system than your TV supports. Should this happen, you can press the OPEN button to eject the disc tray, and then use the Setup Menu to correct the "TV System" setting.

7. Output Resolution

To choose the output resolution that best matches your television's native resolution. For a detailed description on how to choose a proper output resolution, please refer to the "Select the Best Output Resolution" section of this manual.

8. 1080p24 Output

This option only applies to the HDMI output at 1080p resolution. Many Blu-ray discs that originated from theatrical movies are encoded using 24Hz frame rate, the same number of frames per second as the original theatrical film. If your TV properly supports 1080p 24Hz, smoother motion can be achieved by enabling 1080p24 output for such discs. The available options are:

Auto (default) – Video encoded in 24Hz frame rate will be output as 1080p 24Hz if the TV informs the player that it can support the 1080p24 signal.

On – Video encoded in 24Hz frame rate will be output as 1080p 24Hz without regard to whether the TV can support the 1080p24 signal or not. This is useful if the TV can actually support 1080p24 but does not properly state its capability. Please note that if the TV cannot support 1080p24, selecting this option will result in no video.

Off – Video encoded in 24Hz frame rate will be converted to 50Hz (PAL) or 60Hz (NTSC)

9. HDMI Options

To configure video options that apply only to the HDMI output. This item contains a sub-menu of the Video Setup menu allowing configuration of some video settings that are unique to the HDMI outputs. To enter this sub-menu, select "HDMI Options" from the Video Setup menu.

To exit this sub-menu, press the **↩** button or the **←** key. Options are present for HDMI1 (using the Marvell QDEO scaler) and HDMI2 (using the scaler built into the Mediatek chipset).

The following HDMI options are available:

Colour Space (HDMI 1) – Used select the colour space for the HDMI 1 output.

The Marvell QDEO scaler can perform various conversions for this output. The available options are:

Auto (Recommended) – The player checks with the display device to automatically determine what colour spaces it can support and uses those. Usually avoids extra colour space conversion.

RGB Video Level – Forces the HDMI output to use RGB colour space and normal signal range suitable for TV type displays.

RGB PC Level – Forces the HDMI output to use RGB colour space and expands the signal range that to suitable for personal computer (PC) type displays.

Mostly used for TVs with DVI inputs designed to be also used as PC monitors, these can expect signal in expanded RGB range when the DVI input is selected. For these displays if the video signal uses the normal RGB range, the black-white contrast will be reduced. You can set the player to use the RGB PC Level output and restore proper contrast.

YCbCr 4:4:4 – The HDMI output is forced to use the YCbCr 4:4:4 colour space.

YCbCr 4:2:2 – The HDMI output is forced to use YCbCr 4:2:2 colour space. Generally this is the colour space that is closest to the colour space encoded on the discs. (Discs are generally encoded in YCbCr 4:2:0 colour space, and the video decoder decodes it into YCbCr 4:2:2.)

Colour Space (HDMI 2) – To select the colour space for the HDMI 2 output. The Mediatek decoders own in-built scaler is used for this output. The available options are the same as those for HDMI 1.

HDMI Deep Colour (HDMI 1) – To select Deep Colour modes for the HDMI 1 output. Deep Colour is an OPTION for some TVs or projectors that feature HDMI v1.3 or higher input.

Normally, each pixel of the video image is transmitted using 24-bit data (8-bit per channel for R, G, B or Y, Cb, Cr). If Deep Colour is supported on your TV each pixel of the video image can be transmitted using 30-bit (10-bit per channel) or 36-bit (12-bit per channel) data. The increased bit depth should result in smoother colour transitions and better gradients for better picture quality.

For BD discs with native deep colour on them the extra information will be passed to the TV. For up-scaled content such as DVDs the deep colour output will be interpolated but can still result in a smoother picture. The dithering/limiting options allow discs with deep colour content to be sent to TVs with limited deep colour support.

Dithering is a way to softly limit any extra colour information in the source material that the display cannot handle by adding 'noise' to prevent an abrupt step in the levels.

Setup menu continued

The available options are:

36 Bits – Always use the maximum 36-bit per pixel Deep Colour mode for the output.

30 Bits (Dithered) – Use the 30-bit per pixel Deep Colour mode with dithering of any over 30 bit content.

30 Bits – Use the 30-bit per pixel Deep Colour mode and hard limit output at 8 bits per colour.

Off (Dithered) – Do not use Deep Colour, dithering any over 24 bit content.

Off (default) – Do not use Deep Colour, hard limit output at 8 bits per colour.

HDMI Deep Colour (HDMI 2) – Select the Deep Colour mode for the HDMI 2 output. The available options are the same as those for HDMI 1.

Note: Since the Deep Colour feature is OPTIONAL and may not be supported by all TVs, enabling Deep Colour while connected to a TV without this feature may result in no effect or no video.

At the time of writing, no BD discs are yet encoded with Deep Colour.

Demo Mode – To enable a special split-screen demonstration mode. This is designed for the demonstration of the QDEO video processing technology. It can also be used as an aid for setting picture control adjustments for Noise Reduction, Colour Enhancement and Contrast Enhancement. It should NOT be used for normal movie watching. The available options are:

On – The video screen will be split in half. The left side shows video without the help of QDEO video processing, and the right side demonstrates the result of QDEO video processing.

Off (default) – Normal viewing mode.

Note: The demo mode is cancelled automatically whenever the player is turned off.

Video Only (HDIM 1) – To choose whether to only send video signal (no audio signal) to **HDIM 1** terminal or not. The available options are:

Yes – Only video signal is sent to HDMI 1 terminal. This can be useful if you use HDMI 1 only for video display, no need to lower the volume or mute the HDTV connected to it.

No (default) – Both video and audio signals are sent to HDMI 1 terminal.

10. Display Options

To configure the options for displaying on-screen information. The following display options are available:

Subtitle Shift – To set the display position for subtitles. When the “Subtitle Shift” is set at 0 (default), subtitles are displayed at the original position as specified on the disc. When it is set at a value between 1 and 5, subtitles are shifted up. When it is set at a value between -1 and -5, subtitles are shifted down. This feature is helpful for instance to customers using a 2.35:1 “Constant Image Height” video projection system. Subtitles can be shifted to the active video area so they do not get cut off.

OSD Position – To set the display position for on-screen display (OSD). When the “OSD Position” is set at 0, OSD is shown at the top and bottom of the video screen. When it is set at a value between 1 and 5, OSD is shifted towards the vertical center line of the video screen. Similar to the subtitle shift setting above, the “OSD Position” feature is helpful to customers using a 2.35:1 “Constant Image Height” video projection system.

OSD Mode – To select how long the on-screen display information, such as elapsed or remaining time, stays on the TV screen. The available options are:

Normal – On-screen display information stays on the TV screen until the user cancels it.

Silent – On-screen display information shows on the TV screen for a few seconds and then disappears. The front panel display still maintains the selected display information.

Remaining – On-screen display information stays on the TV screen until the user cancels it. By default display remaining time instead of elapsed time.

Angle Mark (on/off) – To turn on/off the display of an angle mark when a DVD or Blu-ray Disc with multiple available angles is played. Keeping the angle mark off avoids distraction from normal movie watching.

PIP Mark (on/off) – To turn on/off the display of a Picture-in-Picture mark when a Blu-ray Disc with secondary video is played. Keeping the PIP mark off avoids distraction from normal movie watching.

SAP Mark (on/off) – To turn on/off the display of a Secondary Audio Program mark when a Blu-ray Disc with secondary video and audio is played. Keeping the SAP mark off avoids distraction from normal movie watching.

Screen Saver – To turn on/off the screen saver function. The screen saver is designed to minimize burn-in concerns for plasma and CRT display devices. The available options are:

On – After about 3 minutes of inactivity, the player will show an animated Cambridge Audio logo moving on a black background. This allows most areas of the screen to rest and gives all areas an equal opportunity to refresh.

Off – The screen saver will not be activated. Use this option if your TV does not have a burn-in issue.

Energy Saver – Video output will be turned off after 3 minutes of inactivity. Many projectors and LCD TVs will go into a standby or sleep mode and turn off their projection lamp or LCD backlight lamp, thus saving energy and prolonging the lamp life. When you press any button on the remote control or the player’s front panel, the screen saver will be cancelled and video output will be restored. If your TV is already in standby or sleep mode, you may need to wake up the TV by pressing a button on its remote or control panel.

Audio Format Setup

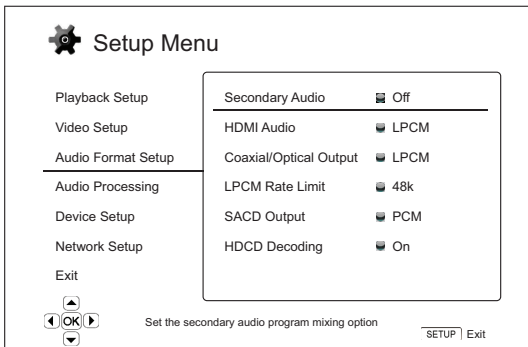

The "Audio Format Setup" section of the Setup Menu system allows you to configure preferences for audio output formats. The menu items in this section are:

Menus	Settings
Secondary Audio	On Off
HDMI Audio.....	Auto LPCM Bitstream Off
Coaxial/Optical Output	LPCM Bitstream
LPCM Rate Limit.....	48K 96K 192K
SACD Output.....	PCM DSD
HDCD Decoding	On Off

1. Secondary Audio

To set the Secondary Audio Program mixing option. Some Blu-ray discs contain a secondary audio and video program, such as a director's commentary. Some Blu-ray Discs have a sound effect when you make menu choices. This Setup Menu item allows you to decide whether to mix the Secondary Audio Program and menu clicking sound into the primary audio. The options are:

On – The Secondary Audio Program and menu clicking sound are mixed into the primary audio. Usually this will cause the primary audio volume to be slightly reduced. High resolution primary audio will be converted to a normal resolution in order to mix with the secondary audio.

Off – The Secondary Audio Program and menu clicking sound are not mixed into the primary audio and you cannot hear the secondary audio or menu clicking sound. This setting preserves the highest possible audio quality for the primary audio.

2. HDMI Audio

To select digital audio output format from the HDMI output. The options are:

Auto (default) – The player checks with the device connecting to HDMI output to automatically determine which audio format to use.

LPCM – Digital audio output via HDMI will be multi-channel Linear PCM format. When this option is selected, compressed audio bit streams will be decoded by the player and then sent as multi-channel PCM. This setting is recommended when connecting the HDMI output directly to a TV or to a receiver without advanced audio decoding capabilities.

Bitstream – Digital audio output via HDMI will be in bitstream format. This option is recommended when connecting the HDMI output to an A/V receiver or processor that supports advanced audio decoding of Dolby TrueHD and DTS-HD Master Audio etc.

Off – No digital audio output via HDMI.

Note: If you use HDMI to connect audio to an HDMI A/V receiver or audio processor, it is important that you choose 720p or higher HDMI output resolution when playing high resolution audio content (DVD-Audio, SACD, Dolby TrueHD and DTS-HD Master Audio). According to the HDMI specification, the bandwidth available for audio is proportional to the total bandwidth used by video. At 480p/576p resolution, the HDMI specification can only support 2 channels of audio with high sample rate (up to 192kHz), or 8 channels of audio with standard sample rate (up to 48kHz). If you play high resolution audio content at the 480p/576p resolution, you may get reduced audio resolution, incomplete audio channels, or even no audio/video output at all. Choosing a higher output resolution such as 720p or above allows enough bandwidth for all high sample rate audio channels.

3. Coaxial/Optical Output

Used to set the output format for the coaxial/optical digital audio outputs. The options are:

LPCM – Forces down-mixed 2-channel digital audio output. Choose this setting if your receiver/amplifier or DAC only supports stereo digital (PCM) audio.

Bitstream – Passes audio as compressed bitstream format to the receiver/amplifier. Choose this setting if your receiver/amplifier is capable of decoding Dolby Digital and/or DTS etc.

4. LPCM Rate Limit

To set the maximum Linear PCM output frequency for the coaxial/optical digital output. This menu item is intended to ensure that the audio output is compatible with equipment that cannot support high sample rates. It sets an upper limit to decide whether the player shall down-sample audio. The options are:

Note: When using the Stereo or 7.1 Analog Audio outputs the LPCM rate limit should always be set to 192kHz to allow the internal playback engine to feed the up-sampler with the maximum sample-rate the content supports.

48kHz – Supported by most equipment. Higher sample rate material will be downsampled to 48kHz.

96kHz – Allows a higher sampling rate and frequency response. If using an externally connected AV receiver or DAC via coaxial or optical, ensure that the receiver/amplifier can support it. Higher sample rate material will be downsampled to 96kHz.

192kHz – Allows the highest sampling rate and frequency response. If using an externally connected AV receiver or DAC via coaxial or optical, ensure that the receiver/amplifier can support it.

5. SACD Output

To select audio output format for SACD. The options are:

PCM – SACD Direct Stream Digital (DSD) data is decoded by the player and converted into multi-channel, high resolution PCM data. The HDMI output can be sent to an external AV receiver capable of receiving multi channel PCM (HDMI 1.1 or higher inputs are required). The 651/751BD's own audio outputs are also active and playback of SACD material is possible by the 651/751BD itself.

DSD – SACD DSD data is output over HDMI without any conversion. For decoding by an external AV receiver capable of receiving DSD (HDMI 1.2a or higher inputs are required and the receiver must actually include support for DSD as it is not a mandatory requirement of the HDMI spec).

Setup menu continued

6. HDCD Decoding

To set the audio decoding option for HDCD (High Definition Compatible Digital) discs. The options are:

On – HDCD is decoded by the 651/751BD. For HDCD discs, this gives expanded dynamic range and improved audio resolution.

Off – HDCD is treated as regular CD and output as a native bitstream preserving the hidden encoding. This is useful when the 651/751BD is connected to an HDCD-capable A/V receiver via a digital audio output link (Coaxial, Optical, or HDMI) the output is unprocessed so the A/V receiver can perform HDCD decoding instead.

Audio signal reference chart

Blu-ray Discs may contain many types of audio signal formats, some of those are of the high resolution lossless types such as Dolby TrueHD and DTS-HD Master Audio. Blu-ray Discs also have many optional audio

components such as the Secondary Audio Program and the menu clicking sound. The player's Audio Format Setup menu allows you to configure the audio output to meet your specific preference. The following chart provides a reference to what type of audio signal can be expected.

When "Secondary Audio" is set to "Off":

Output Type ⇨ Setting Source Format	HDMI Output		Coaxial/Optical Outputs		Analogue Outputs
	Bitstream	LPCM	Bitstream	LPCM	
LPCM 2ch	LPCM 2ch	LPCM 2ch	LPCM 2ch	LPCM 2ch	2ch
LPCM 5.1ch	LPCM 5.1ch	LPCM 5.1ch	LPCM 2ch	LPCM 2ch	5.1ch
LPCM 7.1ch	LPCM 7.1ch	LPCM 7.1ch	LPCM 2ch	LPCM 2ch	7.1ch
Dolby Digital	Dolby Digital	LPCM 5.1ch	Dolby Digital	LPCM 2ch	5.1ch
Dolby Digital Plus	Dolby Digital Plus	LPCM up to 7.1ch	Dolby Digital	LPCM 2ch	Up to 7.1ch
Dolby True HD	Dolby True HD	LPCM up to 192kHz 24-bit 7.1ch	Dolby Digital	LPCM 2ch	Up to 7.1ch
DTS	DTS	LPCM up to 7.1ch	DTS	LPCM 2ch	Up to 7.1ch
DTS-HD High Resolution	DTS-HD High Resolution	LPCM up to 7.1ch	DTS (core)	LPCM 2ch	Up to 7.1ch
DTS-HD Master Audio	DTS-HD Master Audio	LPCM up to 96kHz 24-bit 7.1ch or 192kHz 24-bit 2ch	DTS (core)	LPCM 2ch	Up to 7.1ch

When "Secondary Audio" is set to "On" and the player encounters a disc with secondary audio track or menu clicking sound:

Output Type ⇨ Setting Source Format	HDMI Output		Coaxial/Optical Outputs		Analogue Outputs
	Bitstream	LPCM	Bitstream	LPCM	
LPCM 2ch	DTS* 2ch	LPCM 2ch	DTS*	LPCM 2ch	2ch
LPCM 5.1ch	DTS*	LPCM 5.1ch	DTS*	LPCM 2ch	5.1ch
LPCM 7.1ch	DTS*	LPCM 7.1ch	DTS*	LPCM 2ch	7.1ch
Dolby Digital	DTS*	LPCM 5.1ch	DTS*	LPCM 2ch	5.1ch
Dolby Digital Plus	DTS*	LPCM up to 7.1ch	DTS*	LPCM 2ch	Up to 7.1ch
Dolby TrueHD	DTS*	LPCM up to 192kHz 24-bit 7.1ch	DTS*	LPCM 2ch	Up to 7.1ch
DTS	DTS*	LPCM up to 7.1ch	DTS*	LPCM 2ch	Up to 7.1ch
DTS-HD High Resolution	DTS*	LPCM up to 7.1ch	DTS*	LPCM 2ch	Up to 7.1ch
DTS-HD Master Audio	DTS*	LPCM up to 7.1ch	DTS*	LPCM 2ch	Up to 7.1ch

Note: All audio output signals are mixed with primary, second audio and menu clicking sound.

* Denotes mixed audio re-encoded into DTS bitstream format.

Recommended audio format options

Depending on your specific audio/video connection method, the audio format options of the 651/751BD may need to be adjusted to match your configuration. Please refer to the video and audio connection methods described previously in this guide and the following audio setup guidelines.

Audio connection directly to TV

If the player is connected directly to the TV through HDMI, through DVI and analogue L/R audio cables, or through component video and analogue L/R audio cables, it is recommended that you use the following audio format options:

- Secondary Audio:** On
- HDMI Audio:** LPCM
- SACD Output:** PCM
- HDCD Output:** On
- Coaxial Optical Output:** (any – not in use)
- LPCM Rate Limit:** (any – not in use)

Multi-channel digital audio to Receiver through HDMI

If your receiver supports HDMI v1.3 with decoding capability for high resolution lossless audio formats such as Dolby TrueHD and DTS-HD Master Audio, please set these audio format options:

- Secondary Audio:** Off (or On if you need secondary audio)
- HDMI Audio:** Bitstream
- SACD Output:** PCM (or DSD if the receiver supports DSD over HDMI)
- HDCD Decoding:** On (or Off if the receiver can decode HDCD)
- Coaxial Optical Output:** (any – not in use)
- LPCM Rate Limit:** (any – not in use)

If your receiver supports HDMI v1.1/1.2 Multi-Channel PCM audio, but not high resolution lossless audio formats such as Dolby TrueHD and DTS-HD Master Audio, please set these audio format options:

- Secondary Audio:** Off (or On if you need secondary audio)
- HDMI Audio:** LPCM
- SACD Output:** PCM (or DSD if the receiver supports DSD over HDMI)
- HDCD Decoding:** On (or Off if the receiver can decode HDCD)
- Coaxial Optical Output:** (any – not in use)
- LPCM Rate Limit:** (any – not in use)

Multi-channel analogue audio to Receiver

If the player is connected to an A/V receiver through the 7.1ch or 5.1ch analogue audio jacks using 8 or 6 RCA/Phono cables, you can still play all the supported audio formats and let the 651/751BD decode them and then listen them via your A/V receiver and surround-sound system. The following audio format setup options are recommended:

- Secondary Audio:** Off (or On if you need secondary audio)
- HDMI Audio:** Off
- SACD Output:** PCM (the internal DACs need to use PCM created from the SACDs DSD stream to achieve SACD playback)
- HDCD Decoding:** On
- Coaxial Optical Output:** (any – not in use)
- LPCM Rate Limit:** (any – not in use)

Also set Speaker Configuration in the "Audio Processing" menu:

Set Down Mix to "7.1Ch" or "5.1Ch".

Set the speaker size and subwoofer properly according to your actual audio hardware as detailed on the following pages.

Enable or select the multi-channel analog inputs on your receiver.

Multi-channel digital audio to Receiver through Coaxial or Optical SPDIF

If your receiver only supports Coaxial/Optical, Dolby Digital and DTS decoding, the following audio format setup options are recommended:

- Secondary Audio:** Off (or On if you need secondary audio)
- HDMI Audio:** Off
- SACD Output:** (any – SACD is not available through the optical/coaxial output)
- HDCD Decoding:** On (or Off if the receiver can decode HDCD)
- Coaxial Optical Output:** Bitstream
- LPCM Rate Limit:** 48k (or higher if supported by the receiver)

Stereo analogue audio to Receiver

If your receiver/amp only offers stereo audio connections, you will need to use analogue RCA-style cables to connect to it. For the 751BD use the dedicated Left and Right stereo outputs, for the 651BD use the FL (Front Left) and FR (Front Right) and set the unit to downmix all content to Stereo (see appropriate section in this manual). The following audio format options are recommended:

- Secondary Audio:** Off (or On if you need secondary audio)
- HDMI Audio:** Off
- SACD Output:** PCM (the internal DACs need to use PCM created from the SACDs DSD stream to achieve SACD playback)
- HDCD Decoding:** On
- Coaxial Optical Output:** (any – not in use)
- LPCM Rate Limit:** (any – not in use)

Audio Processing setup

The "Audio Processing Setup" section of the Setup Menu system allows you to configure how the player will process audio signals before sending them to the output.

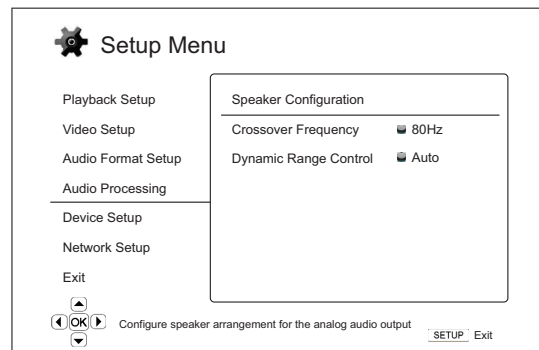

Menus	Settings
Speaker Configuration	
Crossover	40Hz–250Hz
Dynamic Range Control	Auto
	On
	Off

Setup menu continued

Speaker Configuration (7.1 channel analogue audio output only)

The following settings determine how the 651/751BD's internal surround-sound decoder operates. They do not affect audio transmitted over HDMI or S/P DIF/TOSLINK.

In the Speaker Configuration menu you can configure speaker settings such as down-mix mode, number of speakers, their distance, size and trim level. The Speaker Configuration menu shows an illustration of the speaker placements to assist you on properly configuring the speaker parameters.

Upon entering this menu, the cursor is positioned on the front left speaker. You may use the ◀/▶ buttons to move the cursor. The ▶ button moves the cursor in clockwise sequence, and the ◀ button moves the cursor in counterclockwise sequence.

When the cursor is over the "Down Mix" or "Exit" options, you can also use the ▲/▼ buttons to highlight these options.

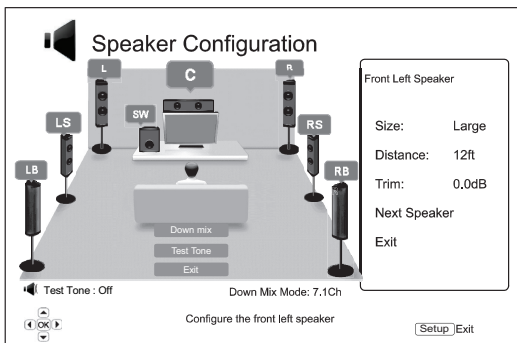

Down Mix Mode

Down mix is the process of converting multi-channel audio to a lesser number of channels. For example, converting a 5.1ch source to stereo or converting a 7.1ch source to 5.1ch. Down mixing allows the audio output from the player to match the exact number of speakers available in your home theatre system.

The current down mix mode is displayed in the lower right corner of the speaker placement illustration.

To change the audio down mix setting, press the Enter button while the cursor is over the "Down Mix" option. The following down mix modes are available:

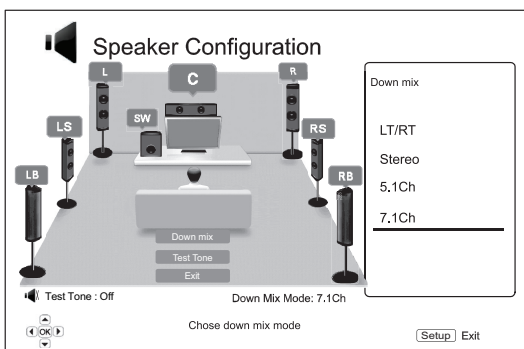

LT/RT – Left Total/Right Total. The centre and surround channels are decoded and then Matrix encoded into the two front channels. A Dolby Pro Logic receiver can then decode the two channel audio that is output back into surround audio.

Stereo - This mode down-mixes multi-channel audio to 2-channel stereo output. For original stereo content the output will not change. For original multi-channel content the surround and centre channels will be mixed with the left and right front channels. Recommended for use with TV sets or stereo receiver/amplifiers (without ProLogic decoding).

5.1Ch – This mode enables 5.1ch decoded audio output. The number of actual output channels depends on the disc. If the source content has more channels, the surround back channels will be mixed into the surround channels.

7.1Ch – This mode enables 7.1ch decoded audio output. The number of actual output channels depends on the disc.

Test Tone

Test tone is a special group of artificially-created sounds that are used to test your audio speaker system and help to identify any wiring faults. By default the Test Tone is set to "Off", with the status is displayed in the lower left corner of the screen.

To begin the test, press the ▲/▼ buttons to highlight the "Test Tone" option, press the Enter button to change the test tone status to "On". Then press ARROW buttons to select a speaker, you will hear the test sounds. To stop the test process, press ▲/▼ buttons to highlight the "Test Tone" option and press the Enter button to switch the status back to "Off". Please note these test tones only apply on multi-channel audio outputs.

Speaker Settings

For each speaker in the home theatre system, you can set its size, distance and trim level. To configure a speaker, move the cursor to highlight the speaker and press the Enter button. The Speaker Settings menu on the right side of the screen will be activated. In the Speaker Settings menu, use the ▲/▼ buttons to select a parameter, and then press the Enter button to change it. To exit the Speaker Settings menu and return to the Speaker Configuration illustration, press the ◀ button or select the "Exit" option. You can also move on to configure the next speaker by selecting the "Next Speaker" option.

The following speaker parameters can be configured:

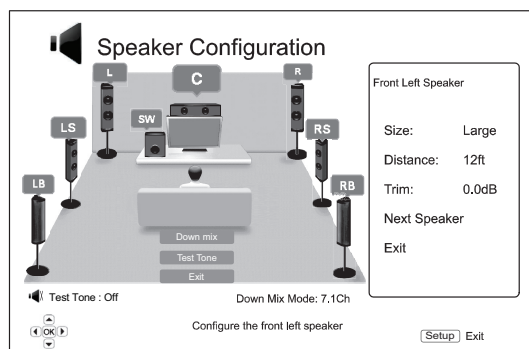

1. Size

The speaker size parameter sets bass filtering control for the speakers. The bass frequency is set in the "Crossover Frequency" option of the "Audio Processing" section of the Setup menu:

Large – Bass frequencies are passed to the speakers.

Small – Bass frequencies are not passed to the speakers to reduce possible distortion. If a subwoofer is available, bass frequencies are redirected to a subwoofer.

On (for subwoofer only) – Specify that a subwoofer is available.

Off – Speaker for the corresponding position does not exist. Audio for the missing speaker is redirected to other speakers or discarded if redirection is not possible.

Note: The front, surround and surround back speakers are configured as pairs. Changes to the size of one speaker will automatically change the other speaker of the pair.

2. Distance

The speaker distance parameters sets delay control for the corresponding audio channel. This delay is used to compensate for the audio propagation time difference caused by the placement of speakers of different distances from the listening position.

Speaker distance delay is only applied if the player is decoding multi-channel audio. If you use bitstream audio output to your A/V receiver, the bitstream audio is not adjusted for speaker distance delay.

Since the delay is calculated based on the distance difference from each speaker to the listener's position, it is important to set the distance for the front speakers first and then the other speakers. Anytime you change the distance of the front speakers, the distance of the other speakers will be automatically adjusted to maintain the same distance difference.

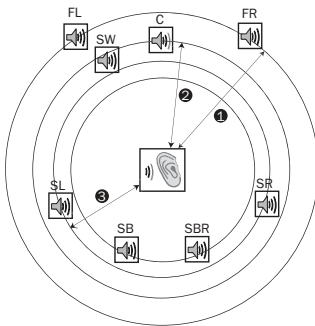

- Distances:
- 1 - Listener to Front
 - 2 - Listener to Centre
 - 3 - Listener to Surround Left
- Speaker Icons:
- FL - Front Left
 - FR - Front Right
 - C - Centre
 - SW - Subwoofer
 - SL - Surround Left
 - SR - Surround Right
 - SBL - Surround Back Left
 - SBR - Surround Back Right

For example, in the above diagram, measure the distance (in feet) from the primary listening position to the Front Left or Front Right Speaker. Your Front Right and Left speakers must be the same distance from the listener. Enter the distance of the Front Speakers (1. in the above picture) into the "Speaker Configuration" menu.

Next, measure the distance (in feet) from the centre speaker (2) to the listening position. Move the cursor to highlight the Centre speaker in the Channel Delay setup page, and enter the distance (as close as possible) in feet. Repeat for each speaker in the system (Centre, Surround Left, Surround Right, Surround Back Left, Surround Back Right and Subwoofer) as available. The player will insert appropriate delay to the center, subwoofer and surround channels to make sure sound waves from different speakers arrive at the listener at the same time.

Notes:

- The distance between the surround speakers and the listener must be shorter than or equal to that between the front speakers and the listener.
- The front, surround and surround back speakers are configured as pairs. Changes to the distance of one speaker will automatically change the other speaker of the pair.

3. Trim

The speaker trim level parameters sets the volume of each individual channel. For most accurate results, it is recommended that you use test tones from a calibration disc, such as Digital Video Essentials HD Basics, and a SPL (Sound Pressure Level) meter. The trim level can be set to +/- 10dB in 0.5dB increments.

Other Audio Processing Settings

1. Crossover Frequency

When the speaker size is set to "Small" in "Speaker Configuration", bass frequencies are not passed to the speakers to reduce possible distortion, bass frequencies will instead be redirected to the subwoofer. The available options are:

40Hz / 60Hz / 80Hz / 90Hz / 100Hz / 110Hz / 120Hz / 150Hz / 200Hz / 250Hz – These are the available crossover frequencies. You can press the \blacktriangle / \blacktriangledown buttons and the Enter buttons to select it. This option applies to all speakers (center, front, surround, and surround back speakers). By default the crossover frequency is 80Hz.

2. Dynamic Range Control

To set the Dynamic Range Compression (DRC). DRC can smooth out the sonic peaks and valleys common with wide-range digital audio. Enabling DRC may make low level audio more audible during low-level listening. Turning off DRC restores the sonic energy present in the original recording. The available options are:

Auto – Play at the dynamic range specified by the disc. This option applies to Blu-ray Discs only. For other disc types no dynamic range compression is applied.

On – Turn on dynamic range compression.

Off – Turn off dynamic range compression.

Device Setup

The "Device Setup" section of the Setup Menu system allows you to configure additional player options related to the hardware and control functions. The menu items in this section are:

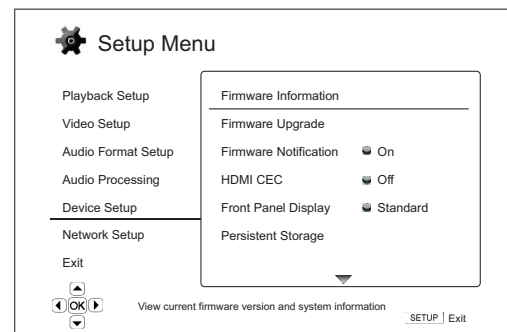

Menus	Settings
Firmware Information	
Firmware Upgrade.....	Via Disc Via USB Via Network
Firmware Notification.....	On Off
HDMI CEC	HDMI 1 HDMI 1 (Limited) HDMI 2 HDMI 2 (Limited) Off
Front Panel Display	Standard Dim Off
Persistent Storage	Storage Device Internal Flash USB Drive Total Space Available Space Erase BD-Video Data
DivX VOD DRM	
Easy Setup	
Reset Factory Defaults	

Setup menu continued

1. Firmware Information

To display the currently installed firmware version.

2. Firmware Upgrade

To upgrade the player's firmware. This operation is only available when the playback is completely stopped or when there is no disc loaded.

The firmware is the system software that controls the features and functions of the player. Since the Blu-ray disc specifications are new and evolving, it is possible that a Blu-ray disc manufactured after the player was manufactured use certain new features of the Blu-ray disc specifications. We may also introduce new features from time to time.

There are three ways to upgrade the player's firmware. The options are:

Via Disc – From time to time, you may be able to download a disc image from the Cambridge Audio's website www.cambridge-audio.com/care and burn an upgrade disc.

Via USB – You may also be able to download the firmware files from Cambridge Audio's web site to a USB drive and then use the USB drive to upgrade the player. For the above two cases closely follow any instructions on our website.

Via Network – If the player has a working Internet connection, you may upgrade the player directly over the Internet. Please follow the instructions on your TV screen.

3. Firmware Notification

To set whether the player should automatically check if new firmware versions are available via the Internet server and notify the user about new firmware. The options are:

On – Check for new firmware version automatically and notify the user about new firmware. Requires working network connection.

Off – Do not check for new firmware version automatically.

4. HDMI CEC

CEC (Consumer Electronics Control) is an optional HDMI feature that can enable convenient remote control and automatic setup of consumer electronics over the HDMI connection. The remote control function allows you to use a single remote handset to operate multiple devices connected via HDMI. For example, you may use the TV remote to control playback of the Blu-ray disc player. The automatic setup function can automatically turn on the TV and change to the correct input when you start playing a disc in the Blu-ray Disc player. It can also turn off the player automatically when you turn off the TV. The implementation and compatibility of this feature varies by device manufacturer. Each may only implement part of the features or add their own proprietary functions. The manufacturer-specific implementation of the HDMI CEC function is often given a proprietary name of "...Link" or "...Sync". The 651/751BD provides three modes for the HDMI CEC function:

HDMI 1 & 2 – HDMI CEC is enabled. Use this mode if your other devices are compatible with the player.

HDMI 1 & 2 (Limited) – HDMI CEC is enabled but the 651/751BD will only respond to playback control commands. It will not respond or issue power on/off and input selection commands. Use this mode if you do not want the automatic setup function to turn on/off your devices.

Off – HDMI CEC feature is turned off. The player will not respond to HDMI CEC commands from other devices, nor will it setup other devices automatically.

5. Front Panel Display

To control the display intensity of the front panel Vacuum Fluorescent Display (VFD) information window. This option allows you to dim it or turn it off. The available options are:

Standard - The VFD window is at full brightness.

Dim - The VFD window is at reduced brightness.

Off – The VFD window is turned off. In this mode the display resumes momentarily when there is any user operation.

6. Persistent Storage

Persistent storage is a data storage area that holds additional contents for BonusView and BD-Live features. The data will be kept even if you turn off the player. The following persistent storage management options are available:

Storage Device – To select which storage device should be used as the persistent storage. The 651/751BD is equipped with 1GB of internal flash memory. There are also two USB 2.0 ports on the player that can accept a USB drive to be used as the persistent storage. The choices are:

Internal Flash – Use the internal flash memory for persistent storage.

USB Drive – Use a USB drive for persistent storage. To meet the specification for BD-Live, a USB flash drive of 1GB or larger is required. A USB hard disk is not recommended.

Note: The new storage device choice becomes effective only after the player is restarted. Please make sure that you turn off the player and then turn it back on after changing the "Storage Device" option.

Total Space – To display the total space of the persistent storage.

Available Space – To display the currently available space of the persistent storage. If the available space becomes too low, some Blu-ray Discs may not play properly.

Erase BD-Video Data – To erase the BD-Video data from the persistent storage.

7. Divx VOD DRM

To register or de-register your player for DivX digital right management for video on demand. A register or de-register code will be generated and shown.

8 Easy Setup

Choose this option to bring up the Easy Setup procedure.

9. Reset Factory Defaults

To reset all settings to the factory default value.

Note: The parental control password and ratings will not be reset. This operation is only available when the playback is completely stopped or when there is no disc loaded.

Network Setup

The "Network Setup" section of the Setup Menu system allows you to configure the parameters for the Internet connection of the player, test the connection and restrict BD-Live access. The menu items in this section are:

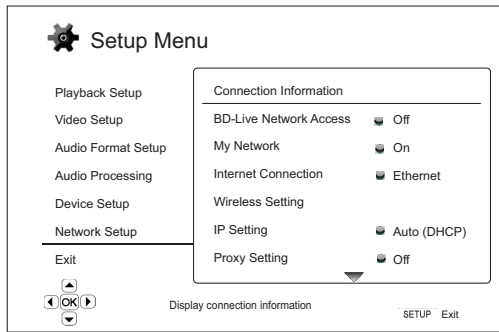

Menus	Settings
Connection Information	
BD-Live Network Access	On Limited Off
My Network.....	On Off
Internet Connection	Ethernet Wireless Off
Wireless Setting	
IP Setting	Auto (DHCP) Manual
Proxy Setting.....	On Off
Connection Test	

1. Connection Information

To display the current internet connection information, such as connection type, IP address, Ethernet MAC, Wireless MAC, etc.

2. BD-Live Network Access

To restrict BD-Live content access. The available options are:

On – BD-Live access is permitted.

Limited – BD-Live access is permitted only for contents that have a valid content owner certificate. Internet access is prohibited if the BD-Live contents do not have a certificate. This option ensures that you are accessing only authentic content, although it may block your access to smaller independent content providers.

Off – BD-Live access is prohibited.

3. My Network

To set the My Network (in-home media sharing) client option. My Network option enables the player to receive streaming audio, video and photo from UPnP media servers on the home network. The available options are:

On (default) – Enable the My Network client. The available media servers are listed in the "My Network" option of Home menu.

Off – Disable the My Network client. No media servers will be shown in "My Network" option, and a warning message will show after you enter "My Network" option.

4. Internet Connection

To select the internet connection type. The available options are:

Ethernet (default) – Connect to internet through the Ethernet cable, please refer to the connection instructions of the manual. Choosing this will make the "Wireless Setting" option grey and un-selectable.

Wireless – Connect to internet through the external wireless adaptor, please refer to the connection instructions of the manual. Choosing "Wireless" will start the wireless setting procedure, and also make the "Wireless Setting" option in the next row selectable.

Off – Internet access is prohibited. This will make all the remaining options in Network Setup screen grey and un-selectable.

5. Wireless Setting

Note: The 751BD includes a wireless adaptor. The 651BD does not. If you wish to use the 651BD wirelessly, contact your Cambridge Audio dealer to obtain a Cambridge Audio wireless adaptor. Other wireless adaptor will not work.

To start the wireless setting procedure. The wireless setting procedure can be started either by selecting the "Wireless Setting" option, or by selecting "Wireless" in "Connection Method" option, the procedure is described as follows:

The player first searches for the last successful wireless settings. If any exist, a message will pop up as below:

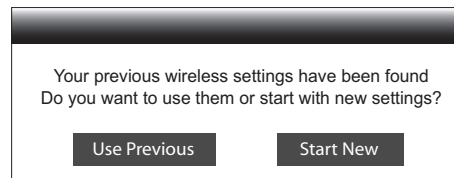

Use Previous – To use the last successful wireless setting. A summary of the previous wireless setting will pop up showing information like SSID (Service Set Identifier), Security Mode and Security Key (in asterisk *).

Then a connection test will be automatically performed and the test result shown on the screen.

Start New – To start a new wireless configuration. The 651/751BD supports three wireless configuration methods and the available options are:

Scan – To scan for available wireless networks. The player automatically scans for any available wireless networks nearby and the search results are listed in a window. You can press the ▲/▼ buttons to highlight a network then press the Enter button to select it. If this network is secured, you need to input the security key using the remote control. Then a connection test will be automatically performed and the test result is shown on the screen.

Manual – To manually set the information for a wireless network. You need to use the remote control to input the SSID, select the Security Mode and input the Security Key. Then a connection test will be automatically performed and the test result is shown on the screen.

WPS – To start the Wi-Fi Protected Setup. 651/751BD supports the WPS standard to provide an easy and secure establishment of a wireless home network. If you have a router/wireless access point that also support WPS. The available options are:

PIN – To configure the WPS using a Personal Identification Number. The player will generate a PIN and you need to input it into the software control panel of your wireless router or access point. Please follow the on-screen instruction.

PBC – To configure the WPS using Push Button Control. You need to push a PBC button on your wireless router or access point to initiate the wireless connection. Please follow the on-screen instruction.

Note:

- SSID is short for Service Set Identifier. It is an identifier for each wireless router or access point, and is also referred as a network name.
- WPS is short for Wi-Fi Protected Setup (WPS). It is the latest standard for easy and secure wireless home network configuration. It is also named Wi-Fi Simple Config. To use WPS, a WPS compatible router or access point is required.

Setup menu continued

6. IP Setting

To determine how the player obtains its IP address. The available options are:

Auto (DHCP) - The player automatically obtains its IP address information using DHCP (Dynamic Host Configuration Protocol). This is the default setting. In most cases, automatic IP configuration is best and requires no user intervention.

Manual - Manually enter the numeric IP address information. For more information on how to manually configure the Internet connection and what values to use, please consult your broadband router/modem instruction manuals or call your Internet service provider.

IP Address - The Internet Protocol address of the player. When "IP Configuration" is set to "Auto (DHCP)", the value displayed here is obtained using DHCP and cannot be changed.

Subnet Mask - Each IP address has an associated subnet mask. It is used by the player to decide whether to route network traffic through the router or directly to another device on the same network. When "IP Setting" is set to "Auto (DHCP)", the value displayed here is obtained using DHCP and cannot be changed.

Gateway - The IP address of the router. It is also called "default gateway" or "default router". When "IP Setting" is set to "Auto (DHCP)", the value displayed here is obtained using DHCP and cannot be changed.

DNS 1 - The IP address of the first (primary) DNS (Domain Name System) server. DNS is the mechanism to translate human-readable addresses to numeric IP addresses. When "IP Setting" is set to "Auto (DHCP)", the value displayed here is obtained using DHCP and cannot be changed.

DNS 2 - The IP address of the second (secondary) DNS server. When "IP Setting" is set to "Auto (DHCP)", the value displayed here is obtained using DHCP and cannot be changed.

7. Proxy Setting

To configure the proxy server settings. A proxy server works as an intermediary for network communication between clients and other servers, which can provide benefits like security, anonymity, speedup or circumventing regional restrictions.

On - To access the Internet via a proxy server.

Proxy Host: To enter the proxy host name using the remote control.

Proxy Port: To enter the proxy host port number using the remote control.

Off (default) - Do not use a proxy server.

8. Connection Test

To test the Internet connection. It is recommended that you test the connection when you initially connect the player to the Internet, or whenever changes to "IP Setting" and other network parameters are made.

Picture Adjustment

Picture Adjustment is a special section of the Video Setup menu. It allows you to fine tune many picture control parameters in order to achieve the optimal picture quality and visual result. To use Picture Adjustment, press the Setup button on the remote control to enter the player's Setup Menu, and then choose "Video Setup" - "Picture Adjustment", then select the primary video output terminal. The Setup Menu will be replaced by the Picture Adjustment menu:

For information on how to choose your primary video output, please refer to Primary Output section of this manual.

Depending on your primary video output, the detailed Picture Adjustment menu will be slightly different as HDMI1 uses the Marvell QDEO scaler which has more sophisticated features and algorithms for adjustment as below.

HDMI 1			
Picture Mode	Mode 1		
Brightness	0	-16	+16
Contrast	0	-16	+16
Hue	0	-16	+16
Saturation	0	-16	+16
Sharpness	0	-16	+16
Noise Reduction	0	0	+8
Color Enhancement	0	0	+4
Contrast Enhancement	0	0	+4
Exit			

To change a picture adjustment parameter, use the ▲/▼ buttons to highlight the parameter, and use the ◀/▶ buttons to change its value.

To aid in the adjustment of picture control parameters, the picture adjustment menu will be reduced to only show the parameter being adjusted once you press the ◀/▶ buttons. The reduced menu will be positioned near the bottom of the screen.

You can continue adjusting the current parameter by pressing the ◀/▶ buttons. To select another parameter, press the ▲/▼ buttons. Press the Enter button to return to the large Picture Adjustment menu.

To exit the Picture Adjustment menu and return to the Setup Menu, either select "Exit" or press the Return button.

The following picture adjustment controls are available, for HDMI1, HDMI2 and Component video:

Picture Mode - The 651/751BD allows you to save up to three (3) customized video modes.

Press the ◀/▶ buttons to switch the mode and all parameters will be automatically adjusted to their stored values. Changes to the current parameter values will be stored automatically when you exit the Picture Adjustment screen or, switch to another Picture Mode.

Brightness - To adjust the brightness (black level) of the video output.

Contrast - To adjust the contrast (white level) of the video output.

Note: Proper brightness and contrast settings are necessary for a quality video output. If you do not have the correct black and white levels, your images can appear washed out or can lose detail in shadows when watching darker scenes. Televisions have brightness (black level) and contrast (white level) controls; however it may require a combination of tweaking both the player and your television to get the optimal result. First adjust the television's picture controls for the best possible picture. Once that is done, try changing the player's settings to further refine the picture to the optimal result.

Hue - To adjust the hue (tint) of the video output.

Saturation -To adjust the saturation (colour intensity level) of the video output.

Sharpness - To set the sharpness of the video output (Detail/Edge Enhancement), this a video processing function that can control the image sharpness but if overdone may cause unwanted artifacts.

For HDMI 1, the sophisticated QDEO video scaler is used sharpness level can be set between -16 and +16. The default is level 0, which turns off sharpness enhancement. The negative levels may be used to reduce or eliminate overly sharpened video, the picture being progressively softened.

The positive levels increase the sharpness. At level 1, the player applies low level Detail Enhancement, during which the video processor isolates the detailed parts from the original image, processes them separately and integrates back before the final output. At level 2, the player increases Detail Enhancement to a higher level. Generally, to make an image "sharper", we recommend using level 1 and 2. At level 3 and above, the player adds Luminance Transition Improvement (LTI) and Chroma Transition Improvement (CTI), which further sharpen the luminance transition and chroma transition. However, we do not recommend using level 3 and above unless the source content is from a poor source.

For HDMI 2 & Analog, the Mediatek chipsets in-built scaler is used and sharpness level can only be set between 0 and +2. The default is level 0. The higher the level, the sharper the video details are. However, too high a sharpness level may cause white line etching around objects.

Noise Reduction – To select whether the player shall apply video noise reduction processing.

For HDMI 1, the noise reduction level can be set between 0 and 8. The default is level 0, which turns off noise reduction. When set to level 1, the QDEO scaler adjusts the picture quality by reducing “mosquito noise” (artifacts around the outlines of objects) and “block noise” (mosaic-like patterns caused by video compression). These two noise reduction are also called Compression Artifacts Reduction (CAR) and have several levels of aggressiveness. When set to level 2, the player applies the Motion Adaptive Video Noise Reduction (VNR), which handles the random noise and the film-grain noise (natural variation of picture intensity caused by film grain).

Its level is automatic because there is a noise estimator circuitry in the video processor that calculates how much noise presents and adjusts the level of VNR accordingly. When set to a high level between 3 and 4, the player applies both CAR and Motion Adaptive VNR, with more aggressive “block noise” reduction at level 4. At level 5, the player applies aggressive CAR for low quality video content, and adds Motion Adaptive VNR at level 6. At level 7, the player applies the most aggressive CAR for very low quality video, and adds Motion Adaptive VNR at level 8. Remember that excessive noise reduction may cause a loss of detail. We recommend using the noise reduction function only when you encounter poorly encoded or compressed video that has apparent noise artifacts.

For HDMI 2 & Analog, the noise reduction level can be set between 0 and +3. The default is level 0. When user increases the level, the player adjusts the picture quality by applying mosquito noise reduction, random noise reduction and MPEG block noise reduction at the same time. The higher level user sets, the more aggressive noise reduction functions apply.

Colour Enhancement (HDMI 1 video output only) – Used to select a colour enhancement level (enhance certain colours in the spectrum) of the video output. It provides the ability to make more vivid some colours without causing hue shifts, loss of details or changes in skin tones.

Contrast Enhancement (HDMI 1 video output only) – Used to select a colour enhancement level (expands details in the shadows) on the video output.

Filters (751BD only)

For all sources the 751BD up-samples all internally decoded material to 24/192kHz via an Analog Devices SHARC DSP.

This runs our proprietary code from Anagram Technologies which performs jitter suppression, up-sampling and anti-alias filtering for all 10 analog outputs (7.1 and Dedicated Stereo).

The front panel Filter button allows cycling between three different anti-alias filters as described below.

The three different Filter functions are: Linear Phase, Minimum Phase and Steep. All three filters are optimised specifically for audio playback. Each offers excellent sound quality but differs subtly in optimisation, hence we've made all three available to you.

Note: For clarity, all diagrams show the theoretical response of the DSP itself, excluding any analog filtering at the DAC outputs or the anti-aliasing filter applied during recording and/or mastering of the digital source.

Linear phase filter frequency response

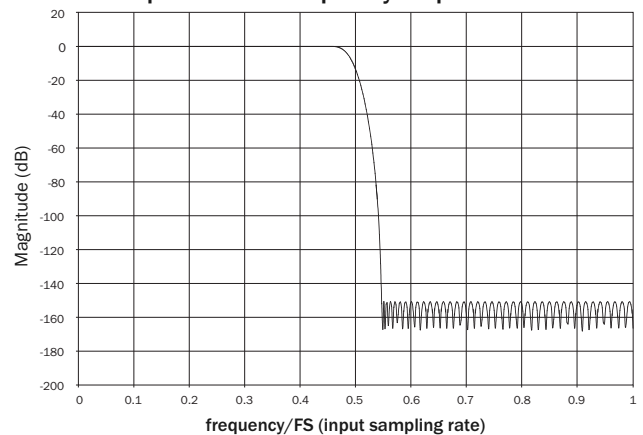

The Linear Phase filter is a highly regarded audio filter offering low ripple in both the pass and stop bands, and what is known as constant group delay. Constant group delay means that audio signals of all frequencies are always delayed by the same amount when passing through the filter. All audio is therefore fully time-coherent at the output.

The trade-off with this type of filter is that due to internal feed-forward in the DSP, its impulse response will exhibit some pre-ringing. In other words, when excited with a theoretical impulse, the output has both a small amount of pre- and post-spike amplitude ringing (albeit well damped).

Linear phase impulse response

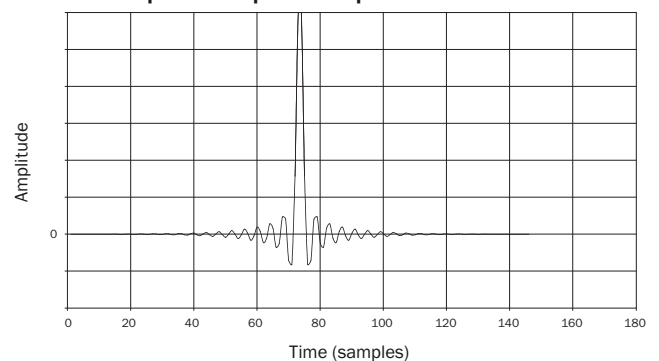

Filters continued

Minimum phase filter frequency response

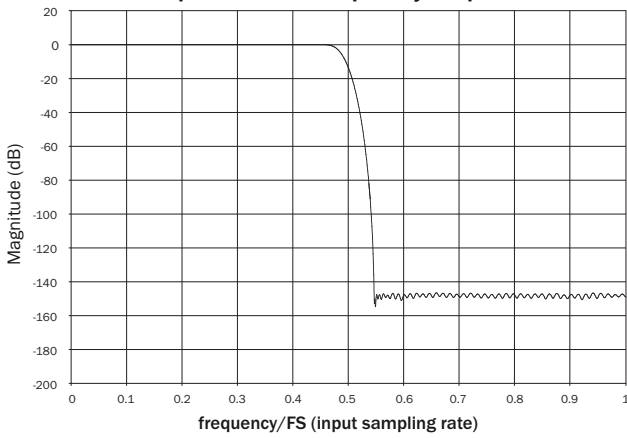

The Minimum Phase filter is another highly regarded audio filter that offers even lower ripple in the pass and stop bands. Unlike the Linear Phase filter, group delay is not constant so some time-coherence is lost; however, phase shift is low and the particular benefit with this filter is that the impulse response exhibits no pre-ringing.

Steep filter frequency response

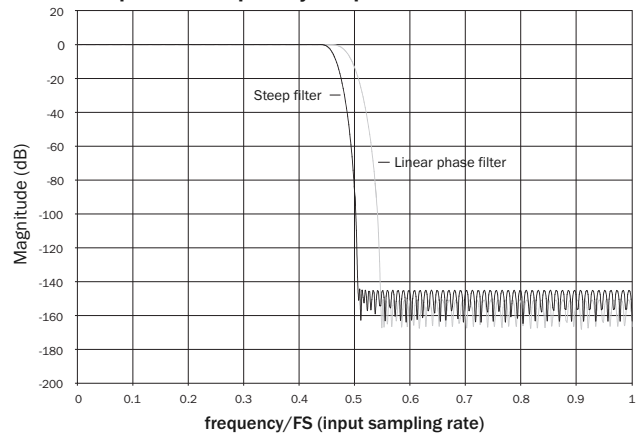

Our Steep filter is a linear phase filter that has been optimised for stop band attenuation of close-in aliasing images. Here we have traded a little attenuation of the very highest frequency response (for 44.1kHz sampled material it would be -2dB at 20kHz) and a little more pre- and post-ringing for a very steep attenuation just outside the pass band. The Steep filter is able to attenuate aliasing at 22kHz by some 80dB.

Minimum phase impulse response

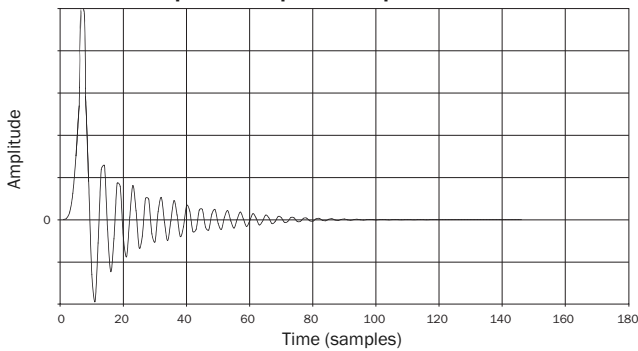

Steep filter impulse response

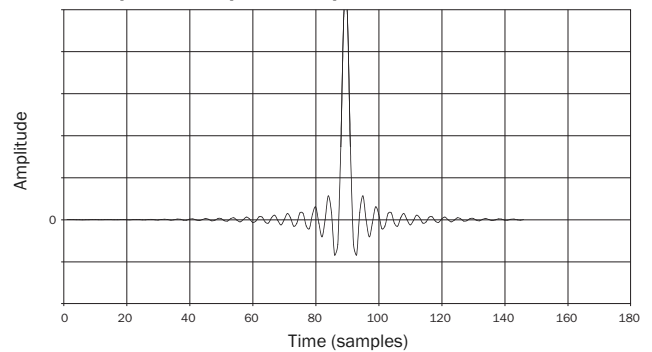

Note: All filters exhibit the same ultimate roll-off of approximately 140dB. The following table shows the filter stop band attenuation for 44.1kHz material as an example:

	Linear Phase	Minimum Phase	Steep
Roll-off at 20kHz	-0.1dB	-0.1dB	-2dB
Roll-off at 22kHz	-10dB	-10dB	-82dB
Ultimate roll-off	140dB	140dB	140dB

We encourage you to experiment with the filters to determine which sound best to your ears and using your source equipment/programme material.

Appendix - language code list

Note: These affect the Audio/Subtitle/Disc menu defaults only not the On Screen menu language.

Code	Language Name	Code	Language Name	Code	Language Name
6565	Afar	7285	Hungarian	8083	Pashto, Pushto
6566	Abkhazian	7289	Armenian	8084	Portuguese
6570	Afrikaans	7365	Interlingua	8185	Quechua
6577	Ameharic	7378	Indonesian	8277	Rhaeto-Romance
6582	Arabic	7383	Icelandic	8279	Romanian
6583	Assamese	7384	Italian	8285	Russian
6588	Aymara	7387	Hebrew	8365	Sanskrit
6590	Azerbaijani	7465	Japanese	8368	Sindhi
6665	Bashkir	7473	Yiddish	8372	Serbo-Croatian
6669	Byelorussian	7487	avanese	8373	Singhalese
6671	Bulgarian	7565	Georgian	8375	Slovak
6672	Bihari	7575	Kazakh	8376	Slovenian
6678	Bengali, Bangla	7576	Greenlandic	8377	Samoaan
6679	Tibetan	7577	Cambodian	8378	Shona
6682	Breton	7578	Kannada	8379	Somali
6765	Catalan	7579	Korean	8381	Albanian
6779	Corsican	7583	Kashmiri	8382	Serbian
6783	Czech	7585	Kurdish	8385	Sundanese
6789	Welsh	7589	Kirghiz	8386	Swedish
6865	Danish	7665	Latin	8387	Swahili
6869	German	7678	Lingala	8465	Tamil
6890	Bhutani	7679	Laothian	8469	Telugu
6976	Greek	7684	Lithuanian	8471	Tajik
6978	English	7686	Latvian, Lettish	8472	Thai
6979	Esperanto	7771	Malagasy	8473	Tigrinya
6983	Spanish	7773	Maori	8475	Turkmen
6984	Estonian	7775	Macedonian	8476	Tagalog
6985	Basque	7776	Malayalam	8479	Tonga
7065	Persian	7778	Mongolian	8482	Turkish
7073	Finnish	7779	Moldavian	8484	Tatar
7074	Fiji	7782	Marathi	8487	Twi
7079	Faroese	7783	Malay	8575	Ukrainian
7082	French	7784	Maltese	8582	Urdu
7089	Frisian	7789	Burmese	8590	Uzbek
7165	Irish	7865	Nauru	8673	Vietnamese
7168	Scots Gaelic	7869	Nepali	8679	Volapuk
7176	Galician	7876	Dutch	8779	Wolof
7178	Guarani	7879	Norwegian	8872	Xhosa
7185	Gujarati	7982	Oriya	8979	Yoruba
7265	Hausa	8065	Panjabi	9072	Chinese
7273	Hindi	8076	Polish	9085	Zulu
7282	Croatian				

ENGLISH

Technical specifications

Both models

Disc types	Blu-ray (BD) including BD-3D, DVD-Video, DVD-Audio, AVCHD, SACD, CD, HDCD, Kodak Picture CD, CD-R/RW, DVD±R/RW, DVD±R DL, BD-R/RE
BD Profile	BD-ROM Version 2 Profile 2 (also compatible with Profile 1 Version 1.0 and 1.1)
Architecture	
Decoder	Mediatek MTK8530
Video Scaler	Marvell DE2750 QDEO Video Scaler (on Primary output)
Internal Storage	1GB (Actual available storage varies due to system usage)
External Storage	2 x USB 2.0, 1 x e-Sata
Analogue audio outputs	7.1 RCA/Phono Can be set for Stereo, 5.1 or 7.1 output
Analogue video outputs	Composite Video (CVBS) Component (YCbCr/YPbPr)
Video Frame Rates	24Hz/50H/60Hz
Video Decoding	MPEG2, MPEG2 HD, MPEG4, MPEG4 AVC, VC-1, XviD, VCD, AVCHD, AVI, VOB, MKV (4.1), JPEG, JPEG HD
HDMI outputs (1.4a) x2	Video NTSC: 480i/p, 720p, 1080i/p, 1080p24, PAL: 576i/p, 720p, 1080i/p, 1080p24 Audio Stereo, up to 7.1ch high-resolution PCM, up to 5.1ch DSD, bitstream or decoding to PCM of Dolby Digital, Dolby Digital Plus, Dolby TrueHD, DTS, DTS-HD High Resolution Audio, and DTS-HD Master Audio.
Composite Video	1.0V p-p (75 Ω)
Component Video	Y: 1.0V p-p (75 Ω) Cb/Cr: 0.7V p-p (75 Ω) Pb/Pr: 0.7V p-p (75 Ω)
Ethernet	100BASE-T
IR Emitter In	3.5mm mini jack, isolated, modulated
PSU	Universal switch-mode 100 – 240V AC, IEC inlet
Max power consumption	35W
Standby consumption	<0.5W
Dimensions (H x W x D)	85 x 430 x 312mm (3.3 x 16.9 x 12.3") with feet
Weight (unboxed)	5.0kg (11.0lbs)

651BD

Architecture	
DACs	Cirrus Logic CS4382A 8 channel multi-dac
THD+N @1kHz	< 0.001%
THD+N 20Hz-20kHz	< 0.007%
IMD 19/20kHz	< 0.001%
S/N ratio	> -108dB
Crosstalk @ 1kHz	> -80dB
Total Correlated Jitter	< 350pS

751BD

Architecture	
Upsampler	Analog Devices ADSP-21261 32 bit SHARC® DSP running Anagram Technologies™ Q5 up-sampling to 24 bit/192kHz (All 10 channels)
DACs	5 x Wolfson WM8740 24/192kHz Digital to Analogue converters
Analogue audio outputs	Dedicated stereo RCA/Phono
THD+N @ 1kHz	< 0.001%
THD+N 20Hz-20kHz	< 0.003%
IMD 19/20kHz	< 0.0002%
S/N Ratio	> -108dB
Crosstalk @ 1kHz	> -100dB
Total Correlated Jitter	< 50pS
Wi-Fi	802.11 b/g/n via supplied dongle.

Cambridge Audio's policy is one of continuous improvement. Design and specifications are therefore subject to change without prior notice.

Troubleshooting

There is no power

- Ensure the AC power cord is connected securely.
- Ensure the plug is fully inserted into the wall socket and is switched on.
- Check fuse in the mains plug or adaptor.

The player will not read the disc

- Check the disc is not loaded upside down.
- Check that the disc is not too scratched or dirty.
- The disc type is not supported by this unit.
- Check its region and type.
- Functions on some discs may not work on this unit. This is not a malfunction of the player.

There is no sound

- Ensure that the amplifier is set correctly.
- Check that the interconnects are inserted correctly.
- Check if the output has been set incorrectly to Bitstream or LPCM.

The disc is skipping

- Check that the disc is not too scratched or dirty.
- Ensure that the 651/751BD is on a firm surface and not subject to vibrations.

A low hum or buzz sound can be heard

- Power cords or lighting placed near this product.
- Analogue inputs not connected securely.

No sound from the rear speakers

- Source being played is not recorded in surround-sound.
- Unit has been put to stereo or other down-mix mode.

No sound from the centre speaker

- A stereo mode has been selected.

Remote control is not working

- The batteries are flat.
- The remote is too far from the unit or out of the effective range.

Files on a connected USB device do not play

- If the USB drive is incompatible, or the player encounters errors while reading the USB drive or flash memory card, the screen displays "Device Error". In this case please verify that the USB drive is compatible, and try to unplug the device and re-insert again.
- In some cases, an incompatible USB device may cause the 651/751BD to stop responding. If this occurs simply turn off the power, remove the USB device, and turn the player back on.
- The file type is incompatible (i.e. AAC). Check the supported file types.
- The drive requires too much power from the USB socket.

Problems using HDMI

- Ensure that your screen supports HDCP (High-Definition Copy Protection).
- Ensure your screen is capable of displaying the resolution being output by the Blu-ray player.

Note: Cables which run over 5m may cause sync or grounding issues.

For more frequently asked questions (FAQs), technical advice and information on getting the most out of your 651/751BD, please visit the Support section on Cambridge Audio's website:

www.cambridgeaudio.com/support.php

Cambridge Audio is a brand of Audio Partnership Plc
Registered Office: Gallery Court, Hankey Place
London SE1 4BB, United Kingdom
Registered in England No. 2953313

www.cambridge-audio.com

