

MINX Air

Wireless Music System

User's Manual

ENGLISH

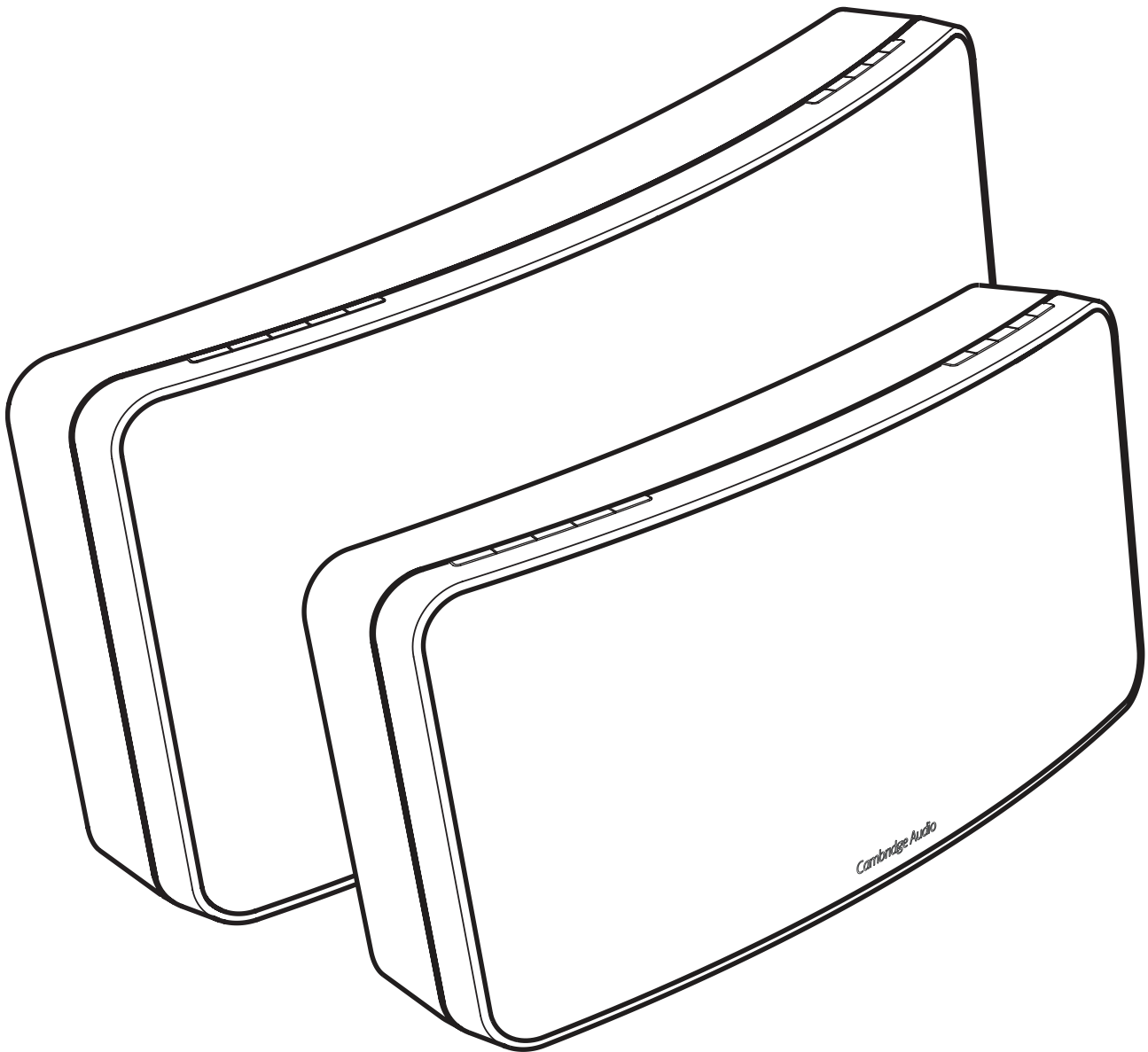

MINX Air 100/Air 200



 **Cambridge Audio**
Your music + our passion

Make sure you register your purchase.

Visit: www.cambridge-audio.com/care

By registering, you'll be the first to know about:

- **Future product releases**
- **Software upgrades**
- **News, events and exclusive offers plus competitions!**

This guide is designed to make installing and using this product as easy as possible. Information in this document has been carefully checked for accuracy at the time of printing; however, Cambridge Audio's policy is one of continuous improvement, therefore design and specifications are subject to change without prior notice.

This document contains proprietary information protected by copyright. All rights are reserved. No part of this manual may be reproduced by any mechanical, electronic or other means, in any form, without prior written permission of the manufacturer. All trademarks and registered trademarks are the property of their respective owners.

© Copyright Cambridge Audio Ltd 2013

The Bluetooth logo is a trademark of Bluetooth SIG

AirPlay works with iPhone, iPad, and iPod touch with iOS 4.3.3 or later, Mac with OS X Mountain Lion, and Mac and PC with iTunes 10.2.2 or later.

AirPlay, iPad, iPhone and iPod touch are trademarks of Apple Inc., registered in the U.S. and other countries.

All other trademarks are the properties of their respective owners.

Contents

Introduction	3
Limited warranty.....	3
Important safety instructions	4
Wi-Fi information	5
Top panel controls.....	6
Rear panel controls.....	7
Remote control	8
Getting started	8
Network connections	8
Connecting to a wireless network	8
Connecting to a wireless network using WPS	9
Connecting to a wired network.....	9
Getting started cont.	10
Playing Internet Radio.....	10
Playing audio from Apple Airplay devices	10
Playing audio from Bluetooth Audio devices	10
Pairing.....	10
Playing back from Bluetooth	11
Audio playback from local analogue sources.....	11
Bass Control	11
Renaming your Minx Air	11
Resetting to Factory Defaults	11
Auto Power Down	11
Standby button	11
WPS LED (next to the WPS button on the rear panel)	11
Troubleshooting.....	12
Technical specifications.....	12

Introduction

Thank you for purchasing a Cambridge Audio Minx Air 100 or Air 200 Wireless Music System. We are confident that you will enjoy many years of listening pleasure from it. Like all Cambridge Audio products Minx Air adheres to our three core principles – stunning performance, ease of use and incredible value.

The Minx Air 100 and Air 200 can wirelessly access a wide range of audio from most phones, tablets or PCs.

Apple Airplay allows content from iPads, iPhones, iPod touch and any PC/Mac running iTunes to be simply sent to the Minx Air.

Airplay not only allows playback from the native music playback features of those devices but also from any streaming service Apps that you have downloaded to them.

You can simply download and use music Apps such as Spotify, Napster, Pandora, Rhapsody or others and direct playback to your Minx Air for the best possible sound quality.

For compatibility with Android phones and tablets and a wide range of other devices, Minx Air also features compatibility with Bluetooth audio.

Any phone, tablet, laptop or PC with Bluetooth audio can play back its content via Bluetooth on the Minx Air. Again this includes any streaming services or other Apps you may wish to download.

In addition the Minx Air units feature our curated Internet Radio service which brings the best stations to you which have been checked by us for reliability and sound quality.

Over 20,000 stations are currently available with more being added each day. These can be browsed and set via our free Apps for both Android and Apple (iOS) devices. These Apps also allow control of the Minx Air for volume, bass, treble and other features and have built in guides to ease the process of first setup of the product on your network.

Internet radio presets can also be recalled from the buttons on the top of the Minx Air or remote control without needing to use the App.

High quality components are used throughout with both models featuring the latest in Digital Signal Processing including a 24-bit DSP running algorithms developed for us by Waves Audio, recipient of a 2011 Technical GRAMMY® award.

Patented BMR (Balanced Mode Radiator) speaker drivers deliver a wider, more room-filling sound than similar-sized traditional speakers.

The Minx Air 100 features two BMRs and 100 watts of output power. The Minx Air 200 features two BMRs plus a Subwoofer and 200watts of output power.

Both models also feature an environmentally friendly low power (<0.5w) standby circuit and an Auto Power Down feature.

Thanks for taking the time to read this manual; we do recommend you keep it for future reference.



Matthew Bramble
Cambridge Audio Technical Director
and the Minx Air development team

Limited warranty

Cambridge Audio warrants this product to be free from defects in materials and workmanship (subject to the terms set forth below). Cambridge Audio will repair or replace (at Cambridge Audio's option) this product or any defective parts in this product. Warranty periods may vary from country to country. If in doubt consult your dealer and ensure that you retain proof of purchase.

To obtain warranty service, please contact the Cambridge Audio authorised dealer from which you purchased this product. If your dealer is not equipped to perform the repair of your Cambridge Audio product, it can be returned by your dealer to Cambridge Audio or an authorised Cambridge Audio service agent. You will need to ship this product in either its original packaging or packaging affording an equal degree of protection.

Proof of purchase in the form of a bill of sale or receipted invoice, which is evidence that this product is within the warranty period, must be presented to obtain warranty service.

This warranty is invalid if (a) the factory-applied serial number has been altered or removed from this product or (b) this product was not purchased from a Cambridge Audio authorised dealer. You may call Cambridge Audio or your local country Cambridge Audio distributor to confirm that you have an unaltered serial number and/or you made a purchase from a Cambridge Audio authorised dealer.

This warranty does not cover cosmetic damage or damage due to acts of God, accident, misuse, abuse, negligence, commercial use, or modification of, or to any part of, the product. This warranty does not cover damage due to improper operation, maintenance or installation, or attempted repair by anyone other than Cambridge Audio or a Cambridge Audio dealer, or authorised service agent which is authorised to do Cambridge Audio warranty work. Any unauthorised repairs will void this warranty. This warranty does not cover products sold AS IS or WITH ALL FAULTS.

REPAIRS OR REPLACEMENTS AS PROVIDED UNDER THIS WARRANTY ARE THE EXCLUSIVE REMEDY OF THE CONSUMER. CAMBRIDGE AUDIO SHALL NOT BE LIABLE FOR ANY INCIDENTAL OR CONSEQUENTIAL DAMAGES FOR BREACH OF ANY EXPRESS OR IMPLIED WARRANTY IN THIS PRODUCT. EXCEPT TO THE EXTENT PROHIBITED BY LAW, THIS WARRANTY IS EXCLUSIVE AND IN LIEU OF ALL OTHER EXPRESS AND IMPLIED WARRANTIES WHATSOEVER INCLUDING, BUT NOT LIMITED TO, THE WARRANTY OF MERCHANTABILITY AND FITNESS FOR A PRACTICAL PURPOSE.

Some countries and US states do not allow the exclusion or limitation of incidental or consequential damages or implied warranties so the above exclusions may not apply to you. This warranty gives you specific legal rights, and you may have other statutory rights, which vary from state to state or country to country.

For any service, in or out of warranty, please contact your dealer.

Plug-fitting Instructions (UK only)

The cord supplied with this appliance is factory-fitted with a UK mains plug fitted with a 3-amp fuse inside. If it is necessary to change the fuse, it is important that a 3-amp fuse is used. If the plug needs to be changed because it is not suitable for your socket, or becomes damaged, it should be cut off and an appropriate plug fitted following the wiring instructions below. The plug must then be disposed of safely, as insertion into a mains socket is likely to cause an electrical hazard. Should it be necessary to fit a 3-pin BS mains plug to the power cord, the wires should be fitted as shown in this diagram. The colours of the wires in the mains lead of this appliance may not correspond with the coloured markings identifying the terminals in your plug. Connect them as follows:

The wire which is coloured BLUE must be connected to the terminal which is marked with the letter 'N' or coloured BLACK.

The wire which is coloured BROWN must be connected to the terminal which is marked with the letter 'L' or coloured RED.

The wire which is coloured GREEN/YELLOW must be connected to the terminal which is marked with the letter 'E' or coloured GREEN.

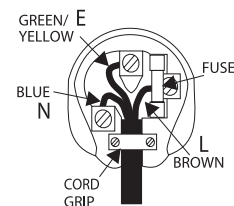

If a standard 13-amp (BS 1363) plug is used, a 3-amp fuse must be fitted or, if any other type of plug is used, a 3-amp or 5-amp fuse must be fitted, either in the plug or adaptor, or on the distribution board.

Important safety instructions

For your own safety please read the following important safety instructions carefully before attempting to connect this unit to the mains power supply. They will also enable you to get the best performance from and prolong the life of the unit:

1. Read these instructions.
2. Keep these instructions.
3. Heed all warnings.
4. Follow all instructions.
5. Do not use this apparatus near water.
6. Clean only with a dry cloth.
7. Do not block any ventilation openings. Install in accordance with the manufacturer's instructions.
8. Do not install near any heat sources such as radiators, heat registers, stoves, or other apparatus (including amplifiers) that produce heat.
9. Do not defeat the safety purpose of the polarized or grounding-type plug. A polarized plug has two blades with one wider than the other. A grounding-type plug has two blades and a third grounding prong. The wide blade or the third prong are provided for your safety. If the provided plug does not fit into your outlet, consult an electrician for replacement of the obsolete outlet.
10. Protect the power cord from being walked on or pinched, particularly at plugs, convenience receptacles and the point where they exit from the apparatus.
11. Only use attachments/accessories specified by the manufacturer.
12. Use with only the cart, stand, tripod, bracket, or table specified by the manufacturer, or sold with the apparatus. When a cart is used, use caution when moving the cart/ apparatus combination to avoid injury from tip-over. 
13. Unplug this apparatus during lightning storms or when unused for long periods of time.
14. Refer all servicing to qualified service personnel. Servicing is required when the apparatus has been damaged in any way, such as the power-supply cord or plug having been damaged, liquid has been spilled or objects have fallen into the apparatus, the apparatus has been exposed to rain or moisture, does not operate normally, or has been dropped.

WARNING

- To reduce the risk of fire or electric shock, do not expose this unit to rain or moisture.
- Batteries (battery pack or batteries installed) shall not be exposed to excessive heat such as sunshine, fire or the like.

The unit must be installed in a manner that makes disconnection of the mains plug from the mains socket outlet (or appliance connector from the rear of the unit) possible. Where the mains plug is used as the disconnect device, the disconnect device shall remain readily operable. Only use the mains cord supplied with this unit.

Please ensure there is ample ventilation (at least 10cm clearance all round). Do not put any objects on top of this unit. Do not situate it on a rug or other soft surface and do not obstruct any air inlets or outlet grilles. Do not cover the ventilation grilles with items such as newspapers, tablecloths, curtains, etc.

This unit must not be used near water or exposed to dripping or splashing water or other liquids. No objects filled with liquid, such as vases, shall be placed on the unit.



The lightning flash with the arrowhead symbol within an equilateral triangle is intended to alert the user to the presence of un-insulated 'dangerous voltage' within the product's enclosure that may be of sufficient magnitude to constitute a risk of electric shock to persons.

The exclamation point within an equilateral triangle is intended to alert the user to the presence of important operating and maintenance instructions in the service literature relevant to this appliance.



The symbol on this product indicates that it is of CLASS II (double insulated) construction.



WEEE symbol

The crossed-out wheeled bin is the European Union symbol for indicating separate collection for electrical and electronic equipment. This product contains electrical and electronic equipment which should be reused, recycled or recovered and should not be disposed of with unsorted regular waste. Please return the unit or contact the authorised dealer from whom you purchased this product for more information.

CE 1588 CE mark

This product complies with European Low Voltage (2006/95/EC), Electromagnetic Compatibility (2004/108/EC) and Environmentally-friendly design of Energy-related Products (2009/125/EC) Directives when used and installed according to this instruction manual. For continued compliance only Cambridge Audio accessories should be used with this product and servicing must be referred to qualified service personnel.



C-Tick mark

This product meets the Australian Communications Authority's Radio communications and EMC requirements.



Gost-R Mark

This product meets Russian electronic safety approvals.

Ventilation

IMPORTANT – The unit will become hot when in use. Do not stack multiple units on top of each other. Do not place in an enclosed area such as a bookcase or in a cabinet without sufficient ventilation.

Ensure that small objects do not fall through any ventilation grille. If this happens, switch off immediately, disconnect from the mains supply and contact your dealer for advice.

Positioning

Choose the installation location carefully. Avoid placing it in direct sunlight or close to a source of heat. No naked flame sources, such as lighted candles, should be placed on the unit. Also avoid locations subject to vibration and excessive dust, cold or moisture. The unit can be used in a moderate climate.

This unit must be installed on a sturdy, level surface. Do not place in a sealed area such as a bookcase or in a cabinet. Do not place the unit on an unstable surface or shelf. The unit may fall, causing serious injury to a child or adult as well as serious damage to the product. Do not place other equipment on top of the unit.

Due to stray magnetic fields, turntables or CRT TVs should not be located nearby due to possible interference.

Electronic audio components have a running in period of around a week (if used several hours per day). This will allow the new components to settle down and the sonic properties will improve over this time.

Power sources

The unit should be operated only from the type of power source indicated on the marking label. If you are not sure of the type of power-supply to your home, consult your product dealer or local power company.

This unit can be left in Standby mode when not in use and will draw <0.5W in this state. To turn the unit off, unplug it from the mains socket.

Overloading

Do not overload wall outlets or extension cords as this can result in a risk of fire or electric shock. Overloaded AC outlets, extension cords, frayed power cords, damaged or cracked wire insulation and broken plugs are dangerous. They may result in a shock or fire hazard.

Be sure to insert each power cord securely. To prevent hum and noise, do not bundle the interconnect leads with the power cord or speaker leads.

Cleaning

To clean the unit, wipe its case with a dry, lint-free cloth. Do not use any cleaning fluids containing alcohol, ammonia or abrasives. Do not spray an aerosol at or near the unit.

Battery disposal

Batteries may contain substances harmful to the environment. Please dispose of any discharged batteries with due consideration and in accordance with local environmental/electronic recycling guidelines.

Servicing

These units are not user serviceable. Never attempt to repair, disassemble or reconstruct the unit if there seems to be a problem. A serious electric shock could result if this precautionary measure is ignored. In the event of a problem or failure, please contact your dealer.

Wi-Fi information

FCC Statement

Air 100

FCC ID: YKBMA100-002

IC ID: 9095A-MA100002

Air 200

FCC ID: YKBMA200-003

IC ID: 9095A-MA200003

DECLARATION OF CONFORMITY WITH FCC RULES FOR ELECTROMAGNETIC COMPATIBILITY

We, Cambridge Audio, of Gallery Court, Hankey Place, London SE1 4BB, declare under our sole responsibility that this device,

Air 100/200 with Wi-Fi module

to which this declaration relates, complies with Part 15 of the FCC Rules. Operation is subject to the following two conditions: (1) this device may not cause harmful interference, and (2) this device must accept any interference received, including interference that may cause undesired operation.

Caution: Exposure to Radio Frequency Radiation.

The device shall be used in such a manner that the potential for human contact during normal operation is minimized.

When connecting an external antenna to the device, the antenna shall be placed in such a manner to minimize the potential for human contact during normal operation. This transmitter must not be co-located or operating in conjunction with any other antenna or transmitter.

Federal Communications Commission Notice

This equipment has been tested and found to comply with the limits for a Class B digital device, pursuant to Part 15 of the FCC Rules. These limits are designed to provide reasonable protection against harmful interference in a residential installation.

This equipment generates, uses, and can radiate radio frequency energy, and if not installed and used in accordance with the instructions, may cause harmful interference to radio communications. However, there is no guarantee that interference will not occur in a particular installation. If this equipment does cause harmful interference to radio or television reception, which can be determined by turning the equipment off and on, the user is encouraged to try and correct the interference by one or more of the following measures:

- Reorient or relocate the receiving antenna.
- Increase the distance between the equipment and the receiver.
- Connect the equipment to an outlet on a circuit different from that to which the receiver is connected.
- Consult the dealer or an experienced radio/TV technician for help.

FCC Caution: Any changes or modifications not expressly approved by the party responsible for compliance could void the user's authority to operate this equipment.

IMPORTANT NOTE:

FCC Radiation Exposure Statement:

This equipment complies with FCC radiation exposure limits set forth for an uncontrolled environment. This equipment should be installed and operated with a minimum distance of 20cm between the radiator and your body.

This transmitter must not be co-located or operating in conjunction with any other antenna or transmitter.

2.4GHz operation of this product in the USA is firmware-limited to channels 1 through 11.

Modifications

The FCC requires the user to be notified that any changes or modifications to this device that are not expressly approved by Cambridge Audio, may void the user's authority to operate the equipment.

Canada-Industry Canada (IC)

This Class B digital apparatus complies with Canadian ICES-003

This device complies with Industry Canada licence-exempt RSS standard(s). Operation is subject to the following two conditions: (1) this device may not cause interference, and (2) this device must accept any interference, including interference that may cause undesired operation of the device.

Under Industry Canada regulations, this radio transmitter may only operate using an antenna of a type and maximum (or lesser) gain approved for the transmitter by Industry Canada. To reduce potential radio interference to other users, the antenna type and its gain should be so chosen that the equivalent isotropically radiated power (e.i.r.p.) is not more than that necessary for successful communication.

This radio transmitter 9095A-MA100002 (Air 100) / 9095A-MA200003 (Air 200) has been approved by Industry Canada to operate with the antenna types listed below with the maximum permissible gain and required antenna impedance for each antenna type indicated. Antenna types not included in this list, having a gain greater than the maximum gain indicated for that type, are strictly prohibited for use with this device.

C059-510137-A; Antenna+RG-178 Cable+SMA Plug Reverse, 3.0dBi, 50Ω

This equipment complies with RSS-102 limits set forth for an uncontrolled environment. This equipment should be installed and operated with a minimum distance of 20cm between the radiator and your body.

Cet appareil numérique de Classe B est conforme à la norme Canadienne ICES-003

Le présent appareil est conforme aux CNR d'Industrie Canada applicables aux appareils radio exempts de licence. L'exploitation est autorisée aux deux conditions suivantes : (1) l'appareil ne doit pas produire de brouillage, et (2) l'utilisateur de l'appareil doit accepter tout brouillage radioélectrique subi, même si le brouillage est susceptible d'en compromettre le fonctionnement.

Conformément à la réglementation d'Industrie Canada, le présent émetteur radio peut fonctionner avec une antenne d'un type et d'un gain maximal (ou inférieur) approuvé pour l'émetteur par Industrie Canada. Dans le but de réduire les risques de brouillage radioélectrique à l'intention des autres utilisateurs, il faut choisir le type d'antenne et son gain de sorte que la puissance isotrope rayonnée équivalente (p.i.r.e.) ne dépasse pas l'intensité nécessaire à l'établissement d'une communication satisfaisante.

Le présent émetteur radio 9095A-MA100002 (Air 100) / 9095A-MA200003 (Air 200) a été approuvé par Industrie Canada pour fonctionner avec les types d'antenne énumérés ci-dessous et ayant un gain admissible maximal et l'impédance requise pour chaque type d'antenne. Les types d'antenne non inclus dans cette liste, ou dont le gain est supérieur au gain maximal indiqué, sont strictement interdits pour l'exploitation de l'émetteur.

C059-510137-A; Antenna+RG-178 Cable+SMA Plug Reverse, 3.0dBi, 50Ω

Cet équipement est conforme à RSS-102 limites énoncées pour un environnement non contrôlé. Cet équipement doit être installé et utilisé avec une distance minimale de 20 cm entre le radiateur et votre corps.

IMPORTANT NOTE:

IC Radiation Exposure Statement:

This equipment complies with Canada radiation exposure limits set forth for uncontrolled environments. This equipment should be installed and operated with a minimum distance of 20cm between the radiator and your body.

This transmitter must not be co-located or operating in conjunction with any other antenna or transmitter.

Cet appareil numérique de la classe B conforme à la norme NMB-003 du Canada.

Europe-European Union Notice

Radio products with the CE 1588 or CE alert marking comply with the R&TTE Directive (1995/5/EC) issued by the Commission of the European Community.

Compliance with this directive implies conformity to the following European Norms.

- EN 60950-1 – Product Safety.
- EN 300 328 – Technical requirement for radio equipment.
- EN 301 489 – General EMC requirements for radio equipment.

To determine the type of transmitter, check the identification label on your Cambridge Audio product.

Products with the CE marking comply with European Low Voltage (2006/95/EC), Electromagnetic Compatibility (2004/108/EC) and Environmentally-friendly design of Energy-related Products (2009/125/EC) Directives issued by the Commission of the European Community. Compliance with these directives implies conformity to the following European Norms.

- EN 55022 – Electromagnetic Interference.
- EN 55024 – Electromagnetic Immunity.
- EN 61000-3-2 – Power Line Harmonics.
- EN 61000-3-3 – Power Line Flicker.
- EN 60950-1 – Product Safety Products that contain the radio transmitter are labeled with CE 1588 or CE alert marking and may also carry the CE logo.
- EN 62301:2005 - Household electrical appliances. Measurement of standby power.
- 1275/2008 - Implementing EuP Directive for Standby Power Consumption.

Top panel controls

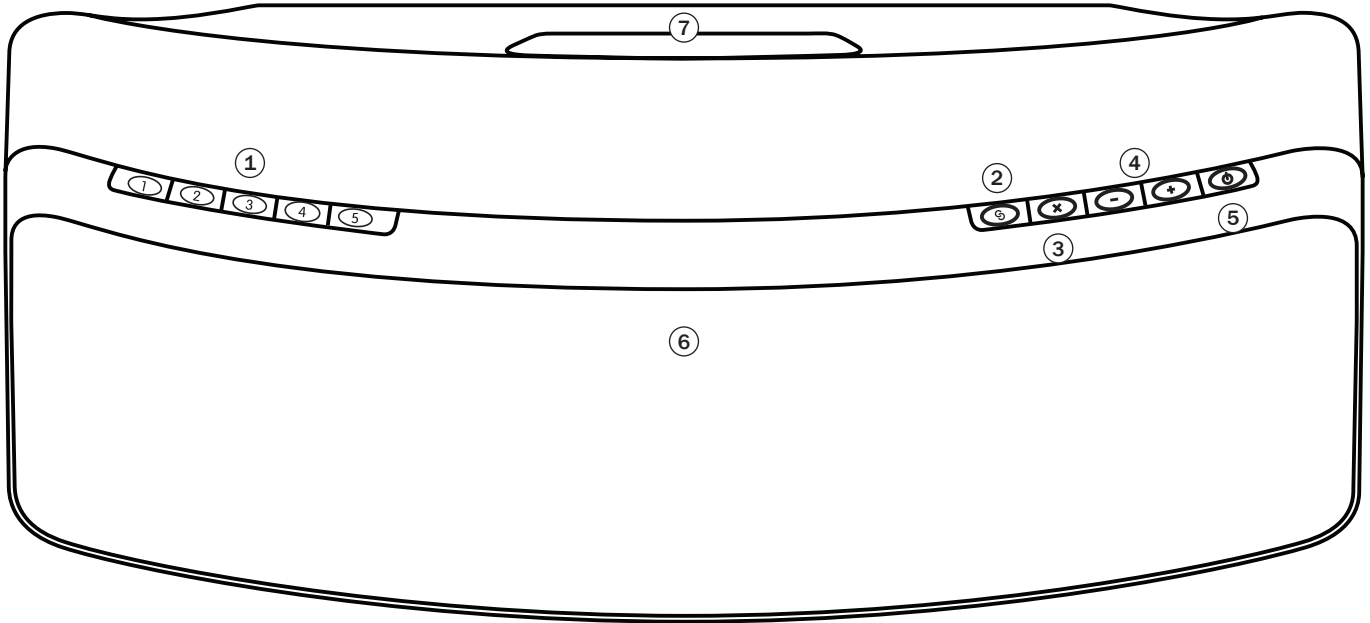

① Internet radio presets

We have preloaded Minx Air with 10 of our favourite internet radio stations. Presets 1-5 can be played by pressing the corresponding preset button. To change the assigned stations use the free Minx Air App for Android or Apple devices, see later section.

② Pairing button

Used to pair (connect to) Bluetooth devices so that they can be played back wirelessly. When the pair button is pressed the button will blink blue for approximately 30 seconds. This indicates that the system is in pairing mode. See later section.

③ X Button

Stops streaming playback (and returns the unit to the analogue inputs).

Starting up streaming playback from Bluetooth, Airplay or Internet Radio will always cause the Minx Air to automatically switch back to that source. Otherwise the system defaults to the analogue inputs.

To stop Bluetooth, Airplay or Internet Radio playback and return to the analogue inputs just press the X button on the top panel. Press a second time to mute the analogue input.

④ Volume controls

The system has two volume control buttons located on the top panel. Volume up is labelled '+', volume down is labelled '-'.

⑤ Standby/On button

Controls the standby state of the unit. When the Standby button is illuminated red, the system is in its <math><0.5\text{W}</math> standby state. When the button is illuminated white the unit is on and ready for playback. When the unit is first turned on, it takes approximately 20 seconds to fully power up and become active. During this phase the button will blink red on and off.

⑥ IR Receiver (behind grille)

A clear unobstructed line of sight between the remote handset and the IR receiver is required for reliable operation.

⑦ Port/Handle

The bass port doubles as a handle for moving your Minx Air from room to room. In use the port provides both an extended low frequency response and cooling. The airflow in/out of the port should not be obstructed.

Rear panel controls



① AC power socket

Figure-8 type mains inlet.

② Bass Control

Changing this setting allows the bass/low frequency response of the Minx Air to be tailored to your taste and the acoustics of your room.

③ WPS Button/Status light

If your router also features Wireless Protected Setup (WPS) this button can simplify connection to your network. See later section.

④ Ethernet socket.

The Minx Air can be connected to your network via wi-fi or Ethernet. Make one connection type not both.

⑤ Service port

For use by authorised Cambridge Audio service personnel only. Do not connect anything here as damage may result.

⑥ MP3 Input (3.5mm mini jack)

For connection to the headphone or line level outputs of MP3 players or similar. When streaming playback is not active both analogue inputs are active instead.

⑦ Audio input (RCA/Phono sockets)

For connection to the line level outputs of CD players, Set-top boxes or other analogue sources, When streaming playback is not active both analogue inputs are active instead.

Remote control

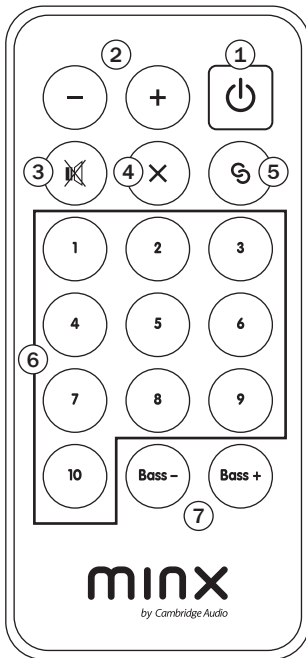

① Standby/On button

Controls the standby state of the unit. When the top panel Standby/On button on the unit itself is illuminated red, the system is in its <0.5W standby state. When the button is illuminated white the unit is on and ready for playback. When the unit is first turned on it takes approximately 20 seconds to fully power up and become active. During this phase the top panel button will blink red on and off.

② Volume buttons

Volume up is labelled '+', volume down is labelled '-'.

③ Mute button

Press to mute and press again to un-mute the unit.

④ X Button

Stops streaming playback (and returns the unit to the analogue inputs).

Starting up streaming playback from Bluetooth, Airplay or Internet Radio will always cause the Minx Air to automatically switch back to that source. Otherwise the system defaults to the analogue inputs.

To stop Bluetooth, Airplay or Internet Radio playback and return to the analogue inputs just press the X button. Press a second time to mute the analogue input.

⑤ Pairing button

Used to pair (connect to) Bluetooth devices so that they can be played back wirelessly. When the pair button is pressed the pair button on the top panel of the unit will blink blue for approximately 30 seconds. This indicates that the system is in pairing mode. See later section.

⑥ Presets buttons 1 – 10

Press to recall an Internet Radio preset. As shipped from the factory 10 stations will have been pre-assigned, 5 can be accessed from the top panel buttons, all 10 can be accessed via the remote. To change the assigned stations use the free Minx Air App for Android or Apple devices, see later section.

⑦ Bass controls

Allows setting of the bass/low frequency response of the unit tailored to your taste and the acoustics of your room.

Bass up is labelled '+' and bass down is labelled '-'.

Getting started

For help connecting Minx Air to your Wi-Fi network, we recommend watching the help videos available at <http://www.cambridgaudio.com/MinxAirSupport>. Also please see the Wi-Fi setup guide supplied with your unit.

Note: If you make a mistake during the connection process, reset the Minx Air. To do this, press and hold the Standby/On button and WPS button on the rear panel for 10-15 seconds until the Minx Air switches off, then repeat the connection process.

Network connections

Before you can use your Minx Air for iRadio/Streaming you must have the following:

- A broadband internet connection (such as ADSL) to a suitable internet service provider (ISP).
- A network connection either wirelessly via 802.11b/g or n Wi-Fi or wired Ethernet connection (10 or 100 M bits/sec via an RJ45 connection).

In many cases the broadband modem, router and wireless access point will be a single combined unit supplied by your Internet Service Provider or bought from a computer store.

If your wireless network is configured to use Wired Equivalent Privacy (WEP) or Wi-Fi Protected Access (WPA) data encryption then you will need to know your WEP or WPA key so you can get the Minx Air to communicate with the network.

IMPORTANT:

Before you continue, make sure that your wireless access point or router is powered up and working with your broadband internet service (use your computer to verify this). To get this part of the system working you must read the instructions supplied with the wireless access point or router.

The Minx Air can be configured to connect to a Wired or Wireless network.

For wired setup, see later section 'Connecting to a wired network'.

Connecting to a wireless network

1. Connect the Minx Air to the mains power and press the ⏻ button on top of the unit. Wait for up to 20 seconds for the flashing light on the rear panel to flash green 🟢 and orange 🟡. If the light does not flash green and orange after 20 seconds, please carry out a factory reset as detailed above, and start again.



2. Go to your computer/tablet and click on the wi-fi/network logo and select Minx Air_XXX.

Mac



PC



iPad



- Open a new page in your internet browser (Internet Explorer, Safari, Chrome etc). In the address bar of your browser, type 192.168.1.1 followed by 'enter' and the Minx Air setup page will be displayed.

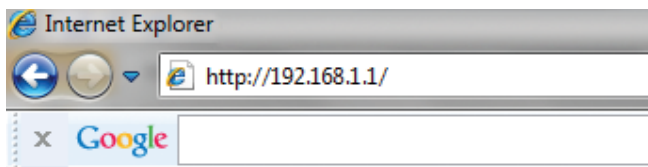

- Select your home wi-fi network from the 'Service Set ID (SSID)' drop down list of choices. The lists shows all the networks the Minx Air can find locally.

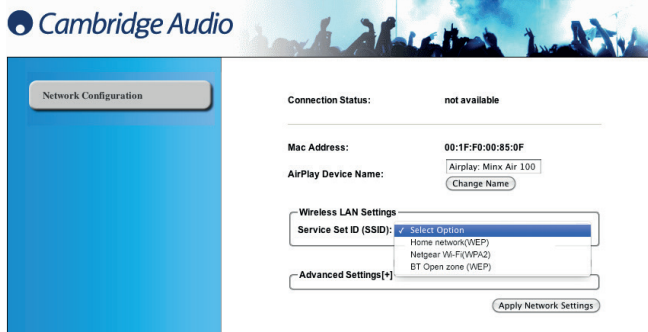

- Now type your home Wi-Fi/Network password into the red box, and click the 'Apply' button.

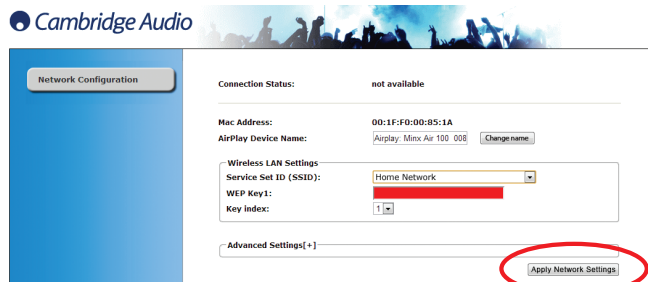

Note: If you don't know your Wi-Fi password key, it's commonly found on a label on your internet modem/router.

- If you are happy that you have entered your details correctly, click 'OK' to finish. The Minx Air set-up page may now display an 'error' or 'no data' received' type message. Don't worry, this is normal. You can now close your internet browser.

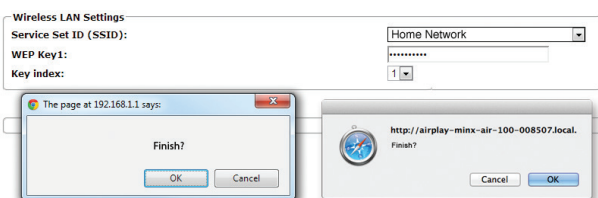

- After a few seconds, the Minx Air will be connected to your network (successful connection is indicated by a solid green light on the rear of the product). This can take up to 30 seconds.

Note:

- If the light on the rear continues flashing green, this indicates that the Minx Air has been unsuccessful with the wi-fi connection. Carry out a factory reset and repeat the process.
- If your computer/tablet has not already done so automatically, change the Wi-Fi/network setting on your computer/tablet back to your home network.

Connecting to a wireless network using WPS

If your router supports WPS (Wi-Fi Protected Setup) then this is a simple method to connect the Minx Air to your network without needing to know your wi-fi network key or broadcast network name SSID.

WPS allows two devices to discover each other for a short time (usually a minute or two) after the WPS buttons have been pressed on both devices.

To connect using WPS simply press the WPS button on your router (please consult router instructions for details) then shortly after press the WPS button on the rear panel of the Minx Air (briefly press it once).



The WPS light on the rear of the Minx Air will flash orange > green > red for up to 2 minutes whilst the Minx Air looks for your router.

If the connection is successful connection the WPS light will turn solid green and your wi-fi connection is ready.

Connecting to a wired network

Note: Make sure that the Minx Air is switched off before plugging in the ethernet cable.

Plug one end of a network cable (Category 5/5E straight through Ethernet cable) into the LAN port on the back of the unit and the other end directly to a free port on your router.

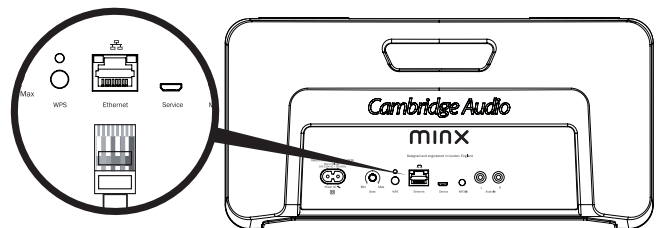

Note: Only connect the LAN port of the player to an Ethernet port that supports 10BASE-T or 100BASE-TX. Connecting to any other ports or jacks, such as a phone jack, can damage the unit. Now turn on your Minx Air.

The Minx Air should automatically connect to your network via DHCP; this means it will be given an IP address by your router automatically.

NOTE: Your Minx Air must first be connected to a network via Wi-Fi or Ethernet for Internet Radio or Airplay streaming to be available.

Playing Internet Radio

The Cambridge Audio Air 100/200 Minx Wireless Music Systems allow playback of over 20,000 internet radio stations.

The Minx Air systems come with ten pre-configured Internet Radio stations set by us at the factory.

Presets 1 - 5 can be accessed directly from the buttons on the top of the unit

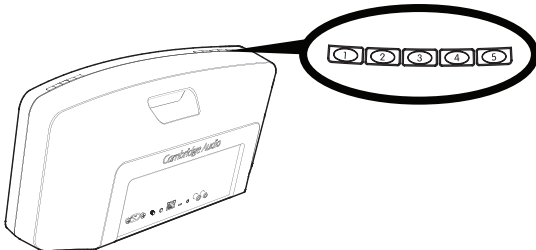

When a station is recalled in this way the  (Pair/Status) button will blink slowly whilst the station is being acquired before turning on permanently once the station is playing, this can take a few seconds.

Presets 1 - 10 can also be accessed from the supplied Infra Red (IR) remote control



Setting your own presets in place of our demonstration ones is done via our free Android and Apple control Apps. which are available via the Apple App. Store and Google Play Store.

These Apps allow browsing of the full range of 20,000+ stations, setting and recall of presets plus full control of your Minx Air unit for volume, bass/treble and more.

Download and install the Minx Control App. to your device and follow the built in instructions. Full details on how to save the stations using the mobile application can be found in the mobile application itself and by watching the videos at <http://www.cambridgeaudio.com/MinxAirSupport>.

Once any Internet radio station is selected and playing via the Minx Air it can be set to a preset simply by pressing and holding the desired preset button on the top of the unit for approximately 4 seconds.

If the station is stored successfully the  (Pair/Status) button on the top of the unit will blink twice.

To set the stations back to the default preset values (also resets all other settings) use the reset to factory default option as described at the end of this manual

Playing audio from Apple Airplay devices

When the Minx Air is connected to your home network it will appear as an Apple Airplay device for audio playback from any Apple devices also on the same network.

When you open iTunes on a network connected computer, or open a compatible Music App on an iPad, iPhone or iPod that is also connected to the same network you will see the Airplay logo .

Tap the Airplay logo and you will be able to select the Minx Air as the playback device.

Select your Minx Air device and start playback, wait a few seconds for music to start playing before adjusting volume.

On an iPad, the Airplay logo is found at the top right of the Music screen.*

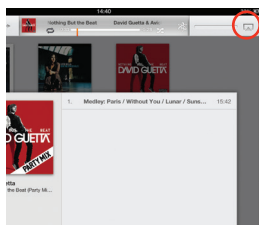

On an iPhone/iPod Touch, the Airplay logo is found at the bottom right of the Music screen.*



In iTunes on a Mac, the Airplay logo is found at the bottom right of the Music screen.*

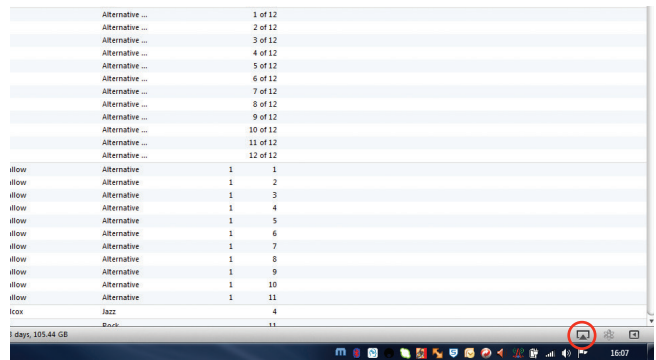

In iTunes on a PC, the Airplay logo is found at the top to the right of the volume slider.*

*Subject to change as Apple change their software.

Playing audio from Bluetooth Audio devices

To play content from a suitable phone, tablet or laptop which features Bluetooth Audio (A2DP or Advanced Audio Distribution Profile) you first need to "pair" that device with the Minx Air.

Pairing

Ensure the Minx Air is turned on.

Press the  (Pair) button on the top of the unit or on the remote handset.

The unit will enter Bluetooth pairing mode. This is indicated by the  button flashing Blue. The unit will remain in Bluetooth pairing mode for 30 seconds. If you have not paired within this time the unit will exit pairing mode. You can re-enter pairing by simply pressing the Pair button again.

When the Minx Wireless Music system is in pairing mode open the Bluetooth settings on your Mobile device. These vary dependant on your device but typically you will find a menu called Bluetooth in your Settings menu.

Enable Bluetooth on your device and select Pairing (or Connect or similar).

Make sure you are within 10m of the Minx Air with a clear line of sight. Your device should show a list of Bluetooth devices it can see. One of these should be "Minx Air 100 XXXX" or "Minx Air 200 XXXX" where the XXXX will be a unique serial number for your unit. Simply select your Minx Air from the list and your device should pair to it automatically.

When the device has successfully paired with your Minx Air the  button on the top of the Minx Wireless Music System will stop flashing

After pairing you should be able to select the Minx Air as the playback device for your Bluetooth phone/tablet without needing to go through the pairing process again unless you wish to use a different device.

Playing back from Bluetooth

When you start playing audio on your paired device the option to stream over Bluetooth should be available. Select Bluetooth or the appropriate name for your Minx Air, Bluetooth playback should begin.

You can use both the volume controls on your Bluetooth device and the Minx Wireless Music system to control the level.

To stop Bluetooth audio, press the **X** (Stop/Mute) button on the top of the Minx Wireless Music System.

To pause Bluetooth audio use the playback controls on the Bluetooth device itself.

Note: The Bluetooth Audio input and the Audio In/MP3 inputs are internally mixed inside the Minx Wireless Music System. This allows for Music to be played back from a Local source (such as CD player) whilst the Minx system is used to playback system notifications from a PC (if connected using the Bluetooth Link).

Audio playback from local analogue sources

To play from a local audio source (such as a MP3 player or CD player) simply connect the audio source to either the "MP3 In" input (3.5mm stereo mini-jack) or the "Audio In" (RCA/Phono) connectors on the rear panel of the unit.

Audio In is suitable for the 'line' outputs of a wide range of equipment such as set-top boxes and CD/DVD players etc.

MP3 In is suitable for the headphone outputs of mobile devices such as MP3 players and phones.

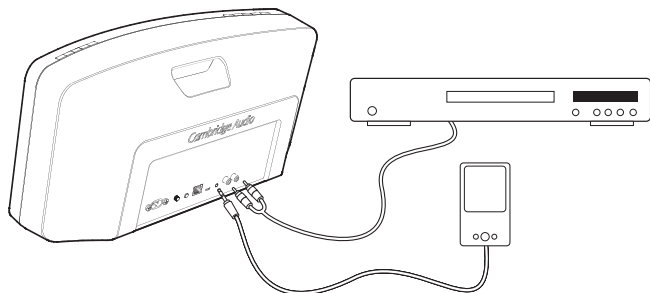

When the Minx Air is not streaming audio from Bluetooth, Airplay or Internet radio is automatically selects the analog audio inputs for playback.

Both inputs are selected and are mixed together. If you wish to use both simply pause /stop playback on one of your connected devices whilst playing the other.

The volume controls on the Minx Wireless Music System can be used to adjust the volume in the normal way.

To mute an analog audio source press the **X** (Stop/Mute) button on the top of the unit. To un-mute the analog audio source press the button again.

Note: Starting to stream audio via Airplay, Internet radio or Bluetooth always takes priority and causes the Minx Air to automatically switch to that streaming source. To return to analog audio playback from streaming simply press the **X** (Stop/Mute) button on the top of the unit, this will stop streaming playback and return the unit to the analog sources.

Bass Control

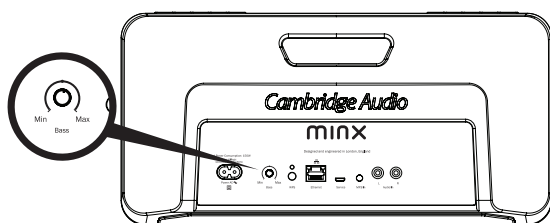

The Bass control can be found on the rear panel of the Cambridge Audio Air 100/200 Wireless Music System. Changing this setting allows the bass/low frequency response of the unit to be tailored to your taste and the acoustics of your room.

In particular, placing the Minx Air in the corner of a room can increase its bass response or in open space decrease it, this control is designed in such a way as to allow the bass response to be adjusted to achieve a natural sound balance in every room.

The Remote handset also includes Bass - and Bass + buttons which do the same thing, these allow assessment and adjustment of the sound balance at a distance.

Renaming your Minx Air

As default, the Minx Air will be named by its serial number. Eg. 'Minx Air 100 008571'. This is how it will appear in the app or when selecting it as your Airplay or Bluetooth speaker.

If you wish, you can rename the Minx Air to something of your choice - for example, 'Minx Air Living Room', or 'Ben's Minx Air'. The easiest way to do this is from within the app, after you have set the Minx Air up and connected it to your network.

To do this, go to Settings > Devices within the app and select the Minx Air speaker that you wish to rename. Then press 'Enter Web Page'. This will open a webpage within the app where you can rename the Minx Air.

Type the desired new name into the Airplay Device Name box, and press 'Change Name'. You will now get a 'new settings were successfully applied message', and your Minx Air will have been renamed. You may need to close and restart the app to reconnect to your newly re-named Minx Air speaker.

Resetting to Factory Defaults

To reset your Minx Air back to its factory defaults (**warning! this will clear any network information, reset the name and EQ and Bass/Volume settings and change the Internet Radio presets back to the factory defined settings**) follow the steps below:

Turn On the unit as usual.

When the small LED above the WPS button on the rear panel is slowly flashing green press and hold the WPS button and Standby button simultaneously for 5 seconds or until the WPS indicator changes to yellow.

The system will now restore the factory settings and power off in approximately 10 seconds.

Auto Power Down

To help save energy the Cambridge Audio Minx Air Wireless Music System will automatically power down if no user activity or audio playback is detected within an adjustable user defined time period. The factory default condition is for the unit to switch-off after eight hours, however this can be adjusted by using the Auto Power Down settings in the iOS and Android Applications.

Help and Troubleshooting

If you experience problems please contact us immediately via our helpline phone numbers (as stated on the sticker affixed to your Minx Air) or via our website. The following description of the status lights of the Minx Air may be useful for troubleshooting and in any correspondence with us.

Standby button

Solid Red - The unit is in its low power standby mode. No audio can be played.

Blinking Red - When coming out of Standby (powering On) the button will blink red for approximately 20 seconds. This indicates that the system is starting up.

Solid White - The system is On and ready to play audio

WPS LED (next to the WPS button on the rear panel)

Solid Green - The unit is connected to a network.

Flashing Green (fast) - The unit is starting up.

Flashing Green (slow) - The unit is in the process of connecting to a network

Flashing Green/Amber/ Red - The unit is in WPS connect mode.

Flashing Green/Amber - The unit is ready for entry of a wi-fi network key via the App.

Flashing Yellow (slow) - There is a problem with the network. Check that the router is switched on and not out of range.

Troubleshooting

If you experience any trouble with your Minx Air, then you may find it useful to visit the help section on our webpage at <http://support.cambridgeaudio.com/>.

General Help guidelines:

If you have trouble connecting the Minx Air to your network, these steps may help to resolve the problem:

- Confirm that a connected PC can access the Internet (i.e. can browse the web) using the same network.
- If you have an encrypted Wi-Fi network, check that you have entered the correct key or passphrase into the Minx Air. Remember that text-format keys are case sensitive.

If your Minx Air can connect to the network successfully, but is unable to play particular internet radio stations, it may be due to one of the following causes:

- The station is not broadcasting at this time of the day (remember it may be located in a different time zone).
- The station has reached the maximum allowed number of simultaneous listeners.
- The station is not broadcasting anymore.
- The link in our database is simply out of date.
- The Internet connection between the server (often located in a different country) and you is slow.
- Try using a PC to play back the stream via the broadcaster's web site.

For all servicing, in or out of warranty, please contact your dealer.

For setup videos, help guides and more FAQs please visit:

<http://www.cambridgeaudio.com/products/minx-air-100>

or

<http://www.cambridgeaudio.com/products/minx-air-200>

Technical specifications

Model:	Minx Air 100 / Minx Air 200
Description:	Wireless Music System
Technical features:	Apple AirPlay technology Bluetooth technology (aptX, AAC and SBC compatible) Internet radio Aux input (RCA and 3.5mm) Digital Signal Processing (DSP) High quality class-D digital amplifier Remote control Adjustable bass control
Drive units:	Minx Air 100 2 x 100mm (4") Balanced Mode Radiator (BMR) drivers Minx Air 200 2 x 57mm (2.25") Balanced Mode Radiator (BMR) drivers 1 x 165mm (6.5") subwoofer
Amplifier power output:	Minx Air 100: 100W Minx Air 200: 200W
Input voltage:	100V – 240V (50/60Hz)
Standby power consumption:	<0.5W
Auto Power Down (APD):	Adjustable from 23hrs 45minutes to 15 minutes, or OFF
Wi-Fi:	IEEE 802.11 b/g
Wi-Fi encryption:	WEP, WPA, WPA2
Ethernet:	IEEE 802.3, 10 Base-T or 100 Base-T
Minx Air 100	
Height:	182mm (7.2")
Width:	354mm (13.9")
Depth:	118mm (4.6")
Net weight:	4.1kg (9.0lbs)
Minx Air 200	
Height:	220mm (7.2")
Width:	450mm (17.7")
Depth:	174mm (6.9")
Net weight:	5.1kg (11.2lbs)
AirPlay compatibility:	AirPlay works with iPhone, iPad, and iPod touch with iOS 4.3.3 or later, Mac with OS X Mountain Lion, and Mac and PC with iTunes 10.2.2 or later.

AirPlay, iPad, iPhone and iPod touch are trademarks of Apple Inc., registered in the U.S. and other countries.

Note: The Minx Air can use SBC, aptX and AAC CODECs for the Bluetooth link. These are used for the Bluetooth link itself and do not represent the music file playback ability of the Minx Air.

For both Airplay and Bluetooth the file playback ability is determined by those file types your source device (phone/tablet etc.) can play.

I.e. if your phone can play it (and send it over Bluetooth or Airplay) Minx Air can play it!

Cambridge Audio is a brand of Audio Partnership Plc
Registered Office: Gallery Court, Hankey Place
London SE1 4BB, United Kingdom
Registered in England No. 2953313

www.cambridge-audio.com

