

Important safety instructions

For your own safety please read the following important safety instructions carefully before attempting to connect this unit to the mains power supply. They will also enable you to get the best performance and prolong the life of the unit:

1. Read these instructions.
2. Keep these instructions.
3. Heed all warnings.
4. Follow all instructions.
5. Do not use this apparatus near water.
6. Clean only with a dry cloth.
7. Do not block any ventilation openings. Install in accordance with the manufacturer's instructions.
8. Do not install near any heat sources such as radiators, heat registers, stoves, or other apparatus (including amplifiers) that produce heat.
9. Do not defeat the safety purpose of the polarized or grounding-type plug. A polarized plug has two blades with one wider than the other. A grounding type plug has two blades and a third grounding prong. The wide blade or the third prong are provided for your safety. If the provided plug does not fit into your outlet, consult an electrician for replacement of the obsolete outlet.
10. Protect the power cord from being walked on or pinched, particularly at plugs, convenience receptacles, and the point where they exit from the apparatus.
11. Only use attachments/accessories specified by the manufacturer.
12. Use only with the cart, stand, tripod, bracket, or table specified by the manufacturer, or sold with the apparatus. When a cart is used, use caution when moving the cart/apparatus combination to avoid injury from tip-over. 
13. Unplug this apparatus during lightning storms or when unused for long periods of time.
14. Refer all servicing to qualified service personnel. Servicing is required when the apparatus has been damaged in any way, such as the power-supply cord or plug being damaged, liquid has been spilled or objects have fallen into the apparatus, the apparatus has been exposed to rain or moisture, does not operate normally, or has been dropped.

WARNING - To reduce the risk of fire or electric shock, do not expose this unit to rain or moisture.

The unit is of Class 1 construction and must be connected to a mains socket outlet with a protective earthing connection.

The unit must be installed in a manner that makes disconnection of the mains plug from the mains socket outlet (or appliance connector from the rear of the unit) possible. Where the mains plug is used as the disconnect device, the disconnect device shall remain readily operable. Only use the mains cord supplied with this unit.

Please ensure there is ample ventilation (at least 10cm clearance all round). Do not put any objects on top of this unit. Do not situate it on a rug or other soft surface and do not obstruct any air inlets or outlet grilles. Do not cover the ventilation grilles with items such as newspapers, table-cloths, curtains etc.

This unit must not be used near water or exposed to dripping or splashing water or other liquids. No objects filled with liquid, such as vases, shall be placed on the unit.



The lightning flash with the arrowhead symbol within an equilateral triangle is intended to alert the user to the presence of un-insulated 'dangerous voltage' within the product's enclosure that may be of sufficient magnitude to constitute a risk of electric shock to persons.

The exclamation point within an equilateral triangle is intended to alert the user to the presence of important operating and maintenance instructions in the service literature relevant to this appliance.

WEEE symbol



The crossed-out wheeled bin is the European Union symbol for indicating separate collection for electrical and electronic equipment. This product contains electrical and electronic equipment which should be reused, recycled or recovered and should not be disposed of with unsorted regular waste. Please return the unit or contact the authorised dealer from whom you purchased this product for more information.

CE mark



This product complies with European Low Voltage (2006/95/EC) and Electromagnetic Compatibility (89/336/EEC) Directives when used and installed according to this instruction manual. For continued compliance only Cambridge Audio accessories should be used with this product and servicing must be referred to qualified service personnel.



C-Tick mark

This product meets the Australian Communications Authority's Radio communications and EMC requirements.



Ross Test Stamp

This product meets Russian electronic safety approvals.

FCC regulations

NOTE: THE MANUFACTURER IS NOT RESPONSIBLE FOR ANY RADIO OR TV INTERFERENCE CAUSED BY UNAUTHORIZED MODIFICATIONS TO THIS EQUIPMENT. SUCH MODIFICATIONS COULD VOID THE USER AUTHORITY TO OPERATE THE EQUIPMENT.



This equipment has been tested and found to comply with the limits for a Class B digital device, pursuant to Part 15 of the FCC Rules. These limits are designed to provide reasonable protection against harmful interference in a residential installation. This equipment generates, uses and can radiate radio frequency energy and, if not installed and used in accordance with the instructions, may cause harmful interference to radio communications. However, there is no guarantee that interference will not occur in a particular installation.

If this equipment does cause harmful interference to radio or television reception, which can be determined by turning the equipment off and on, the user is encouraged to try to correct the interference by one or more of the following measures:

- Re-orient or relocate the receiving antenna.
- Increase the separation between the equipment and receiver.
- Connect the equipment into an outlet on a circuit different from that to which the receiver is connected.
- Consult the dealer or an experienced radio/TV technician for help.

Ventilation

IMPORTANT - The unit will become hot when in use. Do not stack multiple units on top of each other. Do not place in an enclosed area such as a bookcase or in a cabinet without sufficient ventilation.

Ensure that small objects do not fall through any ventilation grille. If this happens, switch off immediately, disconnect from the mains supply and contact your dealer for advice.

Positioning

Choose the installation location carefully. Avoid placing it in direct sunlight or close to a source of heat. No naked flame sources, such as lighted candles, should be placed on the unit. Also avoid locations subject to vibration and excessive dust, cold or moisture. The unit can be used in a moderate climate.

This unit must be installed on a sturdy, level surface. Do not place in a sealed area such as a bookcase or in a cabinet. Any space open at the back (such as a dedicated equipment rack) is fine however. Do not place the unit on an unstable surface or shelf. The unit may fall, causing serious injury to a child or adult as well as serious damage to the product. Do not place other equipment on top of the unit.

Due to stray magnetic fields turntables or CRT TVs should not be located nearby due to possible interference.

Electronic audio components have a running in period of around a week (if used several hours per day). This will allow the new components to settle down, the sonic properties will improve over this time.

Power sources

The unit should be operated only from the type of power source indicated on the marking label. If you are not sure of the type of power supply to your home, consult your product dealer or local power company.

This unit has been designed to be left in Standby mode when not in use, this will increase the life of the amplifier (this is true with all electronic equipment). To turn the unit off completely switch off on the rear panel. If you do not intend to use this unit for a long period of time, unplug it from the mains socket.

Overloading

Do not overload wall outlets or extension cord as this can result in a risk of fire or electric shock. Overloaded AC outlets, extension cords, frayed power cords, damaged or cracked wire insulation, and broken plugs are dangerous. They may result in a shock or fire hazard.

Be sure to insert each power cord securely. To prevent hum and noise, do not bundle the interconnect leads with the power cord or speaker leads.

Cleaning

To clean the unit, wipe its case with a dry, lint-free cloth. Do not use any cleaning fluids containing alcohol, ammonia or abrasives. Do not spray an aerosol at or near the unit.

Battery disposal

Please dispose of any discharged batteries according to local environmental/electronic waste disposal guidelines.

Loudspeakers

Before making any connections to loudspeakers, make sure all power is turned off and only use suitable interconnects.

Servicing

These units are not user serviceable, never attempt to repair, disassemble or reconstruct the unit if there seems to be a problem. A serious electric shock could result if this precautionary measure is ignored. In the event of a problem or failure, please contact your dealer.

Limited warranty

Cambridge Audio warrants this product to be free from defects in materials and workmanship (subject to the terms set forth below). Cambridge Audio will repair or replace (at Cambridge Audio's option) this product or any defective parts in this product. Warranty periods may vary from country to country. If in doubt consult your dealer and ensure that you retain proof of purchase.

To obtain warranty service, please contact the Cambridge Audio authorised dealer from which you purchased this product. If your dealer is not equipped to perform the repair of your Cambridge Audio product, it can be returned by your dealer to Cambridge Audio or an authorised Cambridge Audio service agent. You will need to ship this product in either its original packaging or packaging affording an equal degree of protection.

Proof of purchase in the form of a bill of sale or receipted invoice, which is evidence that this product is within the warranty period, must be presented to obtain warranty service.

This Warranty is invalid if (a) the factory-applied serial number has been altered or removed from this product or (b) this product was not purchased from a Cambridge Audio authorised dealer. You may call Cambridge Audio or your local country Cambridge Audio distributor to confirm that you have an unaltered serial number and/or you purchased from a Cambridge Audio authorised dealer.

This Warranty does not cover cosmetic damage or damage due to acts of God, accident, misuse, abuse, negligence, commercial use, or modification of, or to any part of, the product. This Warranty does not cover damage due to improper operation, maintenance or installation, or attempted repair by anyone other than Cambridge Audio or a Cambridge Audio dealer, or authorised service agent which is authorised to do Cambridge Audio warranty work. Any unauthorised repairs will void this Warranty. This Warranty does not cover products sold AS IS or WITH ALL FAULTS.

REPAIRS OR REPLACEMENTS AS PROVIDED UNDER THIS WARRANTY ARE THE EXCLUSIVE REMEDY OF THE CONSUMER. CAMBRIDGE AUDIO SHALL NOT BE LIABLE FOR ANY INCIDENTAL OR CONSEQUENTIAL DAMAGES FOR BREACH OF ANY EXPRESS OR IMPLIED WARRANTY IN THIS PRODUCT. EXCEPT TO THE EXTENT PROHIBITED BY LAW, THIS WARRANTY IS EXCLUSIVE AND IN LIEU OF ALL OTHER EXPRESS AND IMPLIED WARRANTIES WHATSOEVER INCLUDING, BUT NOT LIMITED TO, THE WARRANTY OF MERCHANTABILITY AND FITNESS FOR A PRACTICAL PURPOSE.

Some countries and US states do not allow the exclusion or limitation of incidental or consequential damages or implied warranties so the above exclusions may not apply to you. This Warranty gives you specific legal rights, and you may have other statutory rights, which vary from state to state or country to country.

Plug Fitting Instructions (UK Only)

The cord supplied with this appliance is factory fitted with a UK mains plug fitted with a 3 amp fuse inside. If it is necessary to change the fuse, it is important that a 3 amp one is used. If the plug needs to be changed because it is not suitable for your socket, or becomes damaged, it should be cut off and an appropriate plug fitted following the wiring instructions below. The plug must then be disposed of safely, as insertion into a mains socket is likely to cause an electrical hazard. Should it be necessary to fit a 3-pin BS mains plug to the power cord the wires should be fitted as shown in this diagram. The colours of the wires in the mains lead of this appliance may not correspond with the coloured markings identifying the terminals in your plug. Connect them as follows:

The wire which is coloured BLUE must be connected to the terminal which is marked with the letter 'N' or coloured BLACK.

The wire which is coloured BROWN must be connected to the terminal which is marked with the letter 'L' or coloured RED.

The wire which is coloured GREEN/YELLOW must be connected to the terminal which is marked with the letter 'E' or coloured GREEN.

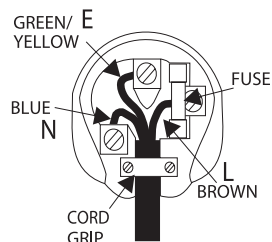

If a standard 13 amp (BS 1363) plug is used, a 3 amp fuse must be fitted, or if any other type of plug is used a 3 amp fuse must be fitted, either in the plug or adaptor, or on the distribution board.

Contents

Important safety instructions	2
Limited warranty.....	3
Introduction	4
Rear panel connections.....	5
Front panel controls.....	6
Remote control.....	6
Audio connections.....	8
Analog video connections.....	9
HDMI connections.....	9
DVD player setup	10
General setup page	10
Speaker setup page	12
Audio Setup menu	14
Video Setup menu	16
Preference menu	17
Basic operating instructions	18
Language code list	20
Technical Specifications	21
Troubleshooting	21

Introduction

Thank you for purchasing this Cambridge Audio DVD player. We hope that you enjoy many years of pleasure from it.

The DVD99 is a 'universal' player that supports DVD-Audio (DVD-A) and Super Audio CD (SACD). These new audiophile formats allow even greater sound quality than CD/DVD and also allow multi-channel surround-sound audio.

In addition, the DVD99 supports DivX® playback for good quality highly compressed video and audio often downloaded from the internet. The DVD99 also features the very latest DVD-D and HDMI outputs for true all digital transmission of video to the TV screen for the very best picture quality currently available.

Your DVD99 can only be as good as the system it is connected to. Please do not compromise on your partnering equipment. Naturally we particularly recommend equipment from the Cambridge Audio range, which have been designed to the same exacting standards as this product. Your dealer can also supply excellent quality Cambridge Audio interconnects to ensure your system realises its full potential.

Thank you for taking the time to read this manual, we do recommend you keep it for future reference.

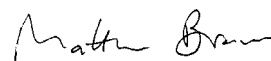

Matthew Bramble,
Cambridge Audio Technical Director
and the DVD player design team.

Visit www.cambridge-audio.com and register to receive notification of future hardware and software releases.

This guide is designed to make installing and using this product as easy as possible. Information in this document has been carefully checked for accuracy at the time of printing; however, Cambridge Audio's policy is one of continuous improvement, therefore design and specifications are subject to change without prior notice. If you notice any errors please feel free to email us at: support@cambridgeaudio.com

This document contains proprietary information protected by copyright. All rights are reserved. No part of this manual may be reproduced by any mechanical, electronic or other means, in any form, without prior written permission of the manufacturer. All trademarks and registered trademarks are the property of their respective owners.

© Copyright Cambridge Audio Ltd 2007

"Dolby", "Pro Logic", "Surround EX" and the double-D symbol are trademarks of Dolby Laboratories.

"DTS", "DTS Digital Surround", "DTS-ES" and "Neo:6" are trademarks of Digital Theater Systems, Inc.

DivX and the DivX logo are registered trademarks of DivX, Inc.

Rear panel connections

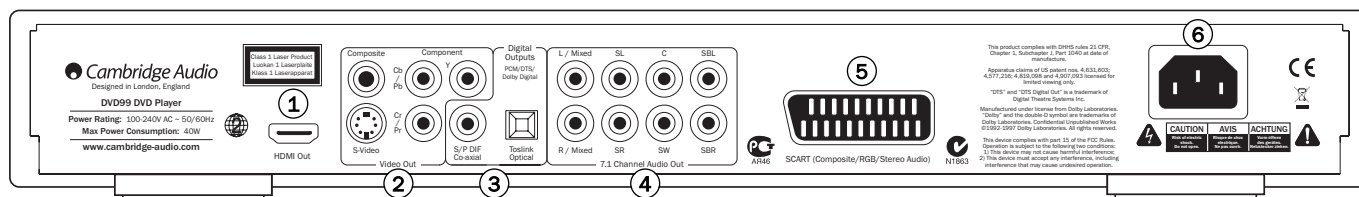

① HDMI Out

HDMI (High-Definition Multi-Media Interface) is a purely digital connection that can carry both audio and video. Use a dedicated HDMI cable to connect to a TV/Monitor with a compatible HDMI input.

② Analog Video Outputs

Composite - Connect to your television via 75 ohm RCA/phono cable designed specifically for video use.

S-Video - Connect to your television via dedicated S-Video cable.

Component - Connect to the YCbCr or YPbPr terminals of a television set via three 75 ohm RCA/phono cables designed specifically for video use.

③ Digital Outputs

Digital audio outputs are normally used to connect to a suitable Audio/Video Receiver for surround sound decoding (output must be set for 'RAW' - refer to the 'Audio setup' section). These outputs can also be used to connect to a separate DAC or digital recording device (output must be set for 'PCM' - refer to the 'Audio setup' section).

Toslink Optical - Use a high quality TOSLINK fibre optic cable.

S/P DIF Co-Axial Digital - Use a high quality 75 ohm digital RCA/Phono interconnect cable designed specifically for digital audio use.

④ 7.1 Channel Audio Out

If Down-mix is set to '7.1 CH' in the Speaker Setup page of the DVD99's Setup menus, these sockets provide 7.1 output from the DVD99's built in Dolby Digital decoder. This can be used to connect to the 7.1 audio line-level inputs of an amplifier/AV receiver or amplified speaker package if required. Similarly, Down-mix can be set to '5.1 CH' to provide 5.1 output. If Down-mix is set to 'LT/RT', 'Stereo' or 'V.Surround' the Left and Right outputs only are active and provide a stereo downmixed output. Refer to the 'Speaker setup page' section of this manual for more information.

⑤ RGB/SCART

Use a SCART/Peritel cable to connect to the 21-pin scart input jack of a TV. SCART carries both audio (stereo) and video (as either Composite, S-Video or RGB) at the same time.

⑥ AC power socket

Once you have made all audio and video connections, plug the IEC type AC power cable into the rear of the unit and an appropriate mains socket then switch on. Your DVD player is now ready for use.

Note: The preferred connection method for video sources is always HDMI (highest quality, and can also carry audio in some circumstances) then Component Video then RGB/SCART then S-Video then Composite Video (lowest quality). The HDMI and Component outputs also support Progressive Scan which gives better picture quality if supported by your TV.

Front panel controls

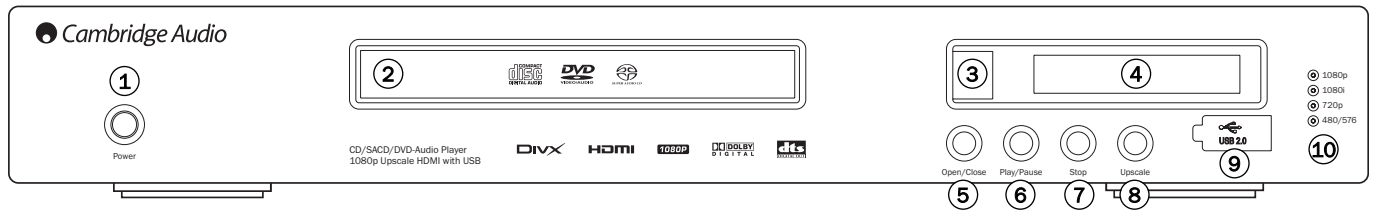

① Power

Switches the unit on and off.

② Disc tray

DVD/Compact Disc tray. Use the *Open/Close* button to activate.

③ IR sensor

Receives IR commands from the supplied remote control. A clear unobstructed line of sight between the remote control and the sensor is required.

④ Display

Used to display the DVD99's functions and playback state etc.

⑤ Open/Close

Allows you to open and close the disc tray for loading of discs. Pressing *Play* will also close the tray and start playing a disc if one is loaded.

⑥ Play/Pause

Plays the disc and pauses (freezes) play when playing.

⑦ Stop

Press once to stop playback. Pressing *Play* will cause the playback to be re-started from the same position. Press again to fully stop playback.

⑧ Upscale

When playback is completely stopped press to switch the video output resolution. Select the resolution that produces the best picture quality on your TV. For most flat panels and DLP™, LCD or LCoS (SXR™, D-ILA™) rear projection televisions this will be 720p. For CRT rear projection televisions this will likely be 1080i. For non HD displays (very rare if they have HDMI or DVI) this will be 480p.

⑨ USB port

Port for interfacing to a flash/memory card or "Mass Storage Device".

Notes:

- Only USB 2.0 certified products with the USB 2.0 logo on them are supported by the DVD99. Please either consult the manufacturer of the USB 2.0 product to make sure it is properly certified, or go to www.usb.org for a list of approved products, before purchase. We cannot be held responsible for any incompatibility issues.
- This unit supports "USB Mass Storage Class Bulk-Only Transport" devices only. Most USB thumb drives, portable hard disk drives and card readers conform to this device class. Other USB devices such as MP3 players, digital cameras, and mobile phones may not be compatible.
- Supported USB drives must be formatted with the FAT (File Allocation Table) or FAT32 file system. Drives formatted with NTFS file system are not supported.

⑩ Resolution indicators

Indicates which HDMI resolution is in use:

1080p - Upscaled at 1080 lines progressive

1080i - Upscaled at 1080 lines interlaced

720p - Upscaled at 720 lines progressive

480/576 - Native NTSC/PAL resolution

Remote control

The DVD99 is supplied with a remote control. Insert the 2 supplied AAA batteries to activate.

For further details of the various adjustment functions available, refer to the later sections of this manual.

⏻ Standby/On

Switches the unit between On and Standby mode.

⏏ Eject

Opens and closes the disc tray.

① Numerical buttons

Press the number of a desired chapter or track to go directly to it. For a number greater than ten, press 10+ followed by the number(s) required.

Go To

Press once to access Chapter Selection then enter the required chapter via the numerical buttons. Press twice to access Disc Time Selection and enter the required time from the start of the disc as H:MM:SS (Hours, Minutes, Seconds). Press three times to access Chapter Time Selection and enter the required time from the start of the chapter.

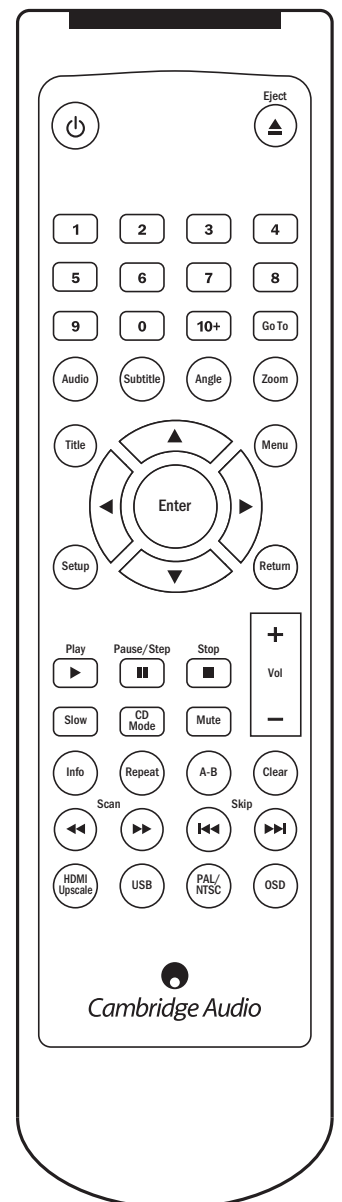

Audio

Press to access alternate audio soundtracks on the DVD (if available on the DVD disc).

Subtitle

Press to enable/disable Subtitles (if available on the DVD disc).

Angle

Press to access various camera angles (if available on the DVD disc).

Zoom

Press to cycle through the various zoom magnifications (and back to normal display).

Navigation

Press the directional arrows to move around the Setup menus.

Enter

Press to accept the item/function highlighted in the display menu.

Title

Press to access the DVD's Title Menu. This is usually the root menu from where the film can be started or where navigation to scene selections, special features etc can be made.

Menu

Press to go to a DVD disc's own setup menu.

Setup

Press to enter the DVD99's Setup menu. Please refer to the 'DVD player setup' section of this manual for more information.

Return

Press to return to the previous operation in any setup menu.

Play / Stop / Pause

Press the relevant button to play, stop or pause playback.

Note: If *Stop* is pressed once playback can be resumed from the same place by pressing *Play*. Press *Stop* twice to completely stop playback. If *Pause* is selected pressing the *Slow* key then allows frame by frame advancement of the paused frame.

Slow

When playing a DVD, press repeatedly to cycle round the various speeds of slow motion, forwards and backwards and back to normal speed).

CD Mode

When a disc is being played, press to turn on/off any connected display device. This function is designed to be used when playing audio only discs to reduce "screen burn".

Mute

During playback, press to turn off audio output. The TV will display "MUTE". Press again to resume audio output.

Volume

Press to decrease or increase the volume of the DVD99.

Note: If the DVD99 is connected to an amplifier/AV receiver through a digital audio output (Co-axial or Optical), the volume command from the remote control is unaffected.

Info

Displays on screen the current DVD disc information not available in the OSD menu. For example disc format, video type and source.

Repeat

Press to repeatedly play a single chapter/title on a DVD video or a single track/entire disc on a CD. The first press selects chapter/track repeat, the second press selects title/disc repeat, the third press selects all repeat.

A-B

Press to mark a segment between A and B for repeated playback. The first press marks point A, the second press marks point B.

Clear

Press to remove outstanding track programs.

Scan

Press repeatedly to cycle between 2X, 4X, 8X, 16X and 32X playback speed (without sound) and back to normal playback. Left button for backwards playback options, right button for forwards playback.

Skip

Right Skip - Press once to skip forward by one track/chapter on the disc.

Left Skip - Press once to skip backward by one track/chapter on the disc.

HDMI Upscale

Press to switch between HDMI output resolution.

Note: Disc playback must be stopped and the Cambridge Audio DVD logo must be displayed.

USB

When a compatible USB device is connected, press this button to bring up a device selection menu. Use the navigational arrows and the Enter button to select 'REMOVABLE' and then select 'USB SLOT'. The DVD99 will then start reading the files stored on the USB device.

PAL/NTSC

Press to switch between the monitor/video display format: PAL, NTSC or Automatic (which switches format automatically depending on the disc inserted).

OSD

While playing a DVD, press to cycle through the following information options to be displayed on the screen: Title Elapsed, Title Remain, Chapter Elapsed, Chapter Remain, Info Off.

Audio connections

Do not plug in the mains power lead or turn the unit on until all connections have been made.

Three types of audio connection can be made between the DVD99 and your stereo/AV system:

- ① Analog Stereo
- ② Digital Audio
- ③ Analog 5.1/7.1

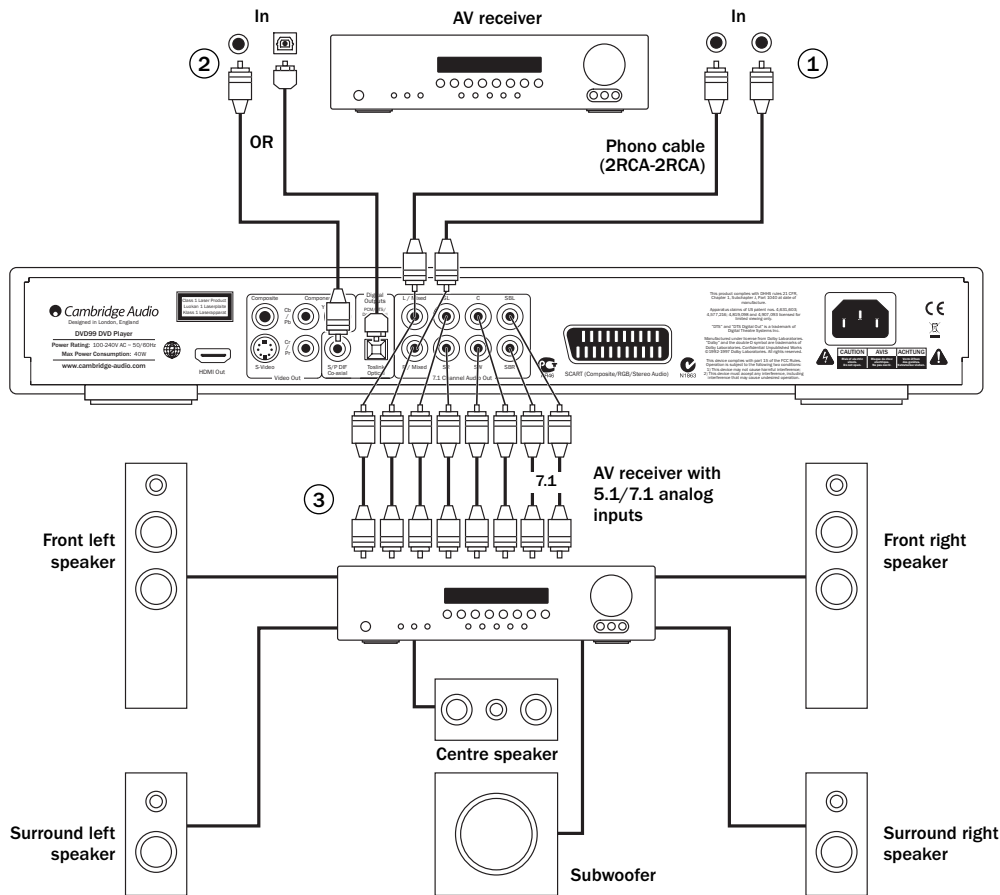

Speaker diagram shown in 5.1 channel setup. For 7.1 add two rear speakers.

① Analog stereo

The analog stereo outputs should be used for playback of CDs, DVDs etc in stereo through a conventional amplifier or AV receiver with analog stereo inputs.

Analog stereo is also usually the best connection method for listening to CDs and other stereo discs for best possible sound quality. It is often a good idea to connect both the analog stereo outputs (for CD playback) and digital audio outputs (for surround sound decoding) at the same time.

To connect an analog stereo system to the DVD99, use stereo phono cables (stereo 2RCA-2RCA).

② Digital audio

The digital audio outputs should be used to decode the surround-sound soundtracks of DVDs with an external AV Receiver (Note: Digital output must be set to 'RAW' in the Audio setup page). The DVD99 sends an undecoded audio bitstream to the AV Receiver for decoding into 5.1/7.1 etc.

Either a 75ohm co-axial cable designed for digital audio or a Toslink fibre optic cable should be used (only one at a time).

Note: It is also possible to output stereo digital audio from the Digital Outputs for recording on conventional CD-R/MD etc. machines, see section on DVD Player setup.

③ Analog 5.1/7.1

The DVD99 is also capable of decoding Dolby Digital 5.1 soundtracks itself and outputting these as analog 5.1/7.1 depending on the number of speakers connected and the setting of Down-mix in the Speaker setup page in the DVD99 setup menu.

For 5.1, connect to an AV receiver or amplified speaker system, use 6 x phono/RCA cables.

For 7.1, connect to an AV receiver or amplified speaker system, use 8 x phono/RCA cables.

Analog video connections

The DVD99 can output video in both fully digital (HDMI) and analog (Composite, S-Video, RGB/SCART and Component) formats. If your TV set supports HDMI then this is the preferred format (see next section).

If your TV set supports only analog video the preferred connection is (in declining order of quality) Component, then RGB/SCART, S-Video and finally Composite.

- ① Component - Connect with 75 ohm Component video cables (3RCA-3RCA).
- ② SCART/RGB - Connect with a dedicated SCART Audio/Video cable.
- ③ S-Video - Connect with S-Video cable.
- ④ Composite - Connect with single 75 ohm video phono cable (RCA-RCA).

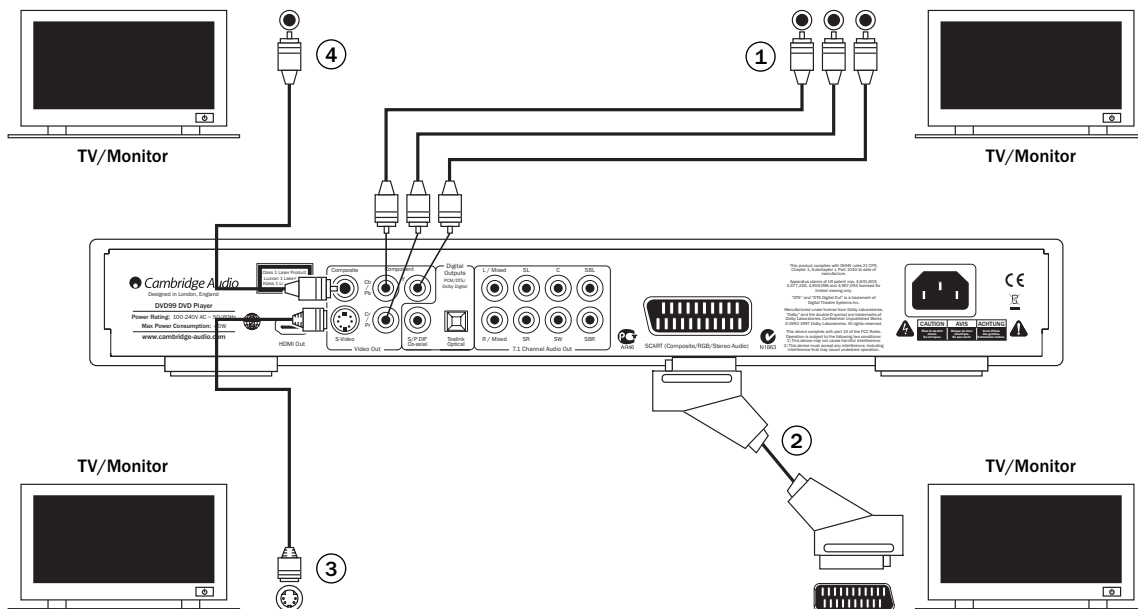

HDMI connections

HDMI (High-Definition Multi-Media Interface) is a digital connection that can carry both audio and video in one cable. Direct digital transfer of video and support for various types of High Definition video content make this the best connection type for picture quality.

DVI output can be supported simply by using DVI to HDMI adaptors as these two connection types are compatible. When using DVI only video will be passed to the TV/Monitor. A Co-axial (SPDIF) or Optical (TOSlink) digital audio connection must be made from the DVD99 to the AV receiver for it to be able to receive audio and decode surround sound etc.

As HDMI can carry both digital audio and video, HDMI can be used to connect to AV receivers that support this function. If your AV receiver is able to receive audio over HDMI only one cable is required*.

***If your AV receiver can switch HDMI but not receive audio in this way, an additional SPDIF or TOSlink cable will be required.**

If the HDMI input of your TV is only capable of decoding 2-channel digital audio, it is recommended that you set the Down-mix to 'Stereo'* in the Speaker setup page in the DVD99 setup menu. This sets the audio down-mix mode of the DVD player to 'Stereo'.

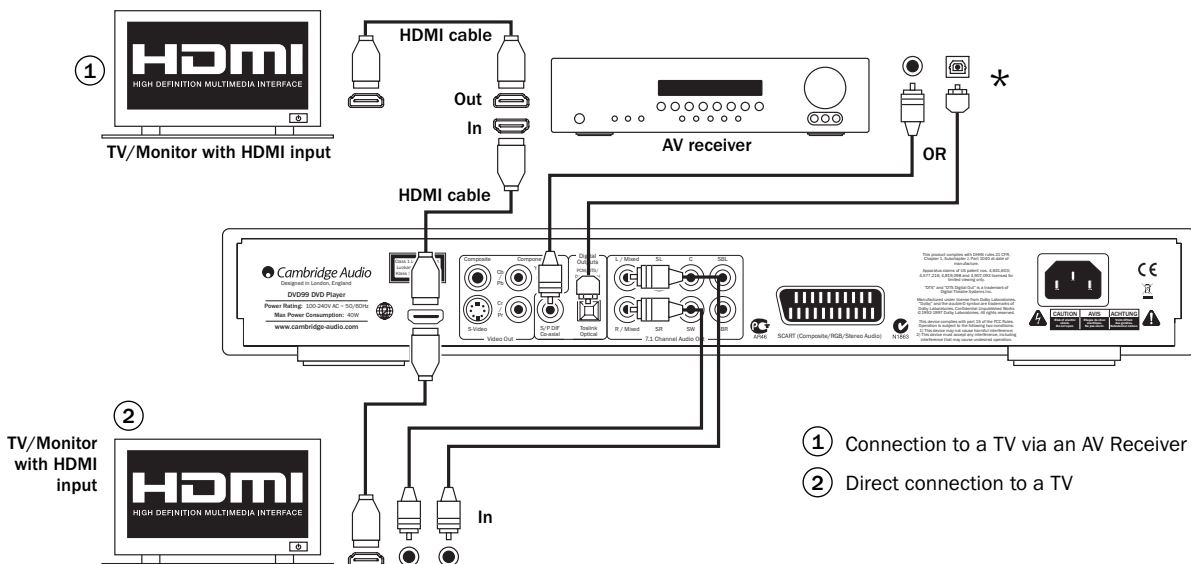

- ① Connection to a TV via an AV Receiver
- ② Direct connection to a TV

DVD player setup



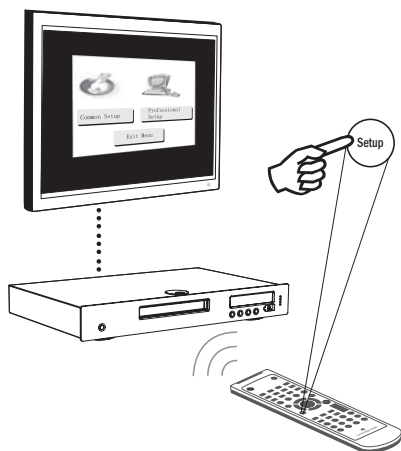

Press the *Setup* button on the remote to enter the Setup menus, Two menu options will be displayed, common and professional:



Select the common setup to setup basic functions, or professional setup for more advanced settings.

Professional Setup Menu

Running along the top of the screen are five icons that represent the five main menu pages:

-  General setup
-  Speaker setup
-  Audio setup
-  Video setup
-  Preference Setup*

*** Note:** To enter the Preferences menu the unit must first be in **Stop mode with the disc drawer out.**

Press *Setup* to enter the menu system. Use the navigation arrows (▲▼◀▶) on the remote to highlight the icon at the top of the screen for the main menu you want to select and then either press ENTER or ▼ to go into that menu and select its first sub-menu. You can now navigate to each sub-menu item you might want to change using ▲▼ and then ◀▶ to select settings.

The yellow highlight always shows the menu or setting you have navigated to, the orange/brown highlight shows the current setting that is being used. Pressing ENTER stores a highlighted setting as the new one to use. To navigate back out of a sub-menu press ◀ to move to the sub menu list if necessary and ◀ again to move to the top main menu list. You can now use ◀▶ to select a new main menu.

Note: Some setup is inter-related with other setup items, and if enabling a function automatically disables another, the disabled function will appear grey and cannot be set.

All setup is saved on exiting the menus and is saved even if the unit is powered off.

General setup page

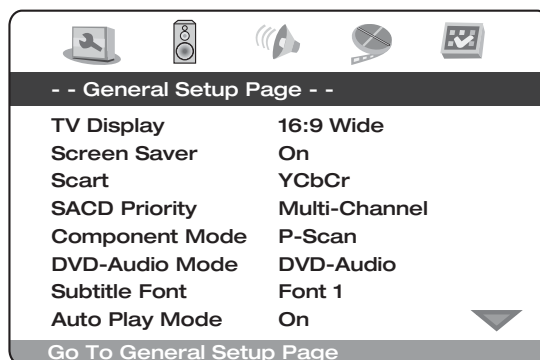

With the General setup page selected, use the ▲ and ▼ buttons to move up/down to the desired sub-menu. Use the navigation buttons (▲▼◀▶) to adjust the settings and press the ENTER button to confirm your selection. See the following list for the General setup page structure:

Menus	Settings
TV Display	4:3 PanScan 4:3 LettBox 16:9 Wide 16:9 Wide/Auto
Screen Saver	On Off
Scart	YCbCr RGB
SACD Priority	Multi-Channel 2-Channel CD Mode
Component Mode	P-Scan Interlace
DVD-Audio Mode	DVD-Audio DVD-Video
Subtitle Font	Font 1 Font 2 Font 3
Auto Play Mode	On Off
DivX(R) VOD	

TV Display

Use to select the screen format to fit your TV screen.

4:3 PanScan - You can select this screen when connected to a normal TV set. The widescreen picture will display on the full screen, but some parts of the video picture will be cut off automatically.



4:3 LettBox - Alternatively you can select this screen when connected to a normal TV set. The full widescreen picture is displayed on the screen with black strips on the top and bottom of the screen.



16:9 Wide - Select this screen when connected to a widescreen TV set. The full picture will now normally be displayed with no picture cropping (unless the movie itself has black bars recorded into the video).

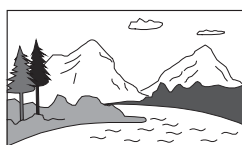

16:9 Wide/Auto - 16:9 (widescreen) as well as 4:3 sources will be displayed in their native aspect ratio. Please note that in this mode 4:3 sources will be displayed with black borders on both sides to maintain the correct 4:3 aspect ratio.

Note: If you are using a plasma or widescreen CRT display you will want to avoid leaving black bars on the screen for any length of time as you may encounter temporary "burn-in" where the display retains memory of the "used" part of screen and the unused (black bar) portions are clearly defined on the screen during subsequent viewing sessions. The "16:9 Wide" mode is the best choice for these types of displays.

Screen Saver

If you activate the screen saver function, when the unit is stopped, the disc tray is open or there is no disc or the picture is still for about 60 seconds, a screen saver picture will appear. The purpose of this screen saver is to protect the display screen from damage (screen burn) by a static image. Screen burn can affect Plasma TVs but LCD and CRT TVs are largely immune to it.

Note: The default setting is 'On'.

SCART

Use to select between the following choices:

RGB - Enables interlaced scan RGB + Sync using the SCART/Peritel output on the rear panel.

YCbCr - Enables interlaced scan component using the 3 phono/RCA component outputs on the rear panel.

SACD Priority

Use to select which audio tracks to play for SACD (Super Audio CD):

Multi-Channel - Play the multi-channel surround audio.

2-Channel - Play the 2-channel stereo audio.

CD Mode - Play the CD layer of a hybrid SACD disc.

Component Mode

Use to select between the following display modes for the Component Video output:

Progressive (P-Scan) - Is a method for displaying, storing or transmitting moving images in which all the lines of each frame are drawn in sequence.

Interlaced - In contrast to progressive, interlacing is used in traditional television systems where only the odd lines, then the even lines of each frame are drawn alternatively.

DVD-Audio Mode

Use to select which portion of a hybrid DVD-Audio disc to playback:

DVD-Audio - Plays the DVD-Audio portion of the disc with surround audio.

DVD-Video - Plays the DVD-Video portion of the disc with Dolby Digital, or DTS audio.

Subtitle Font

Use to select the subtitle font size for DivX video. There are three font sizes available. This setting applies only to DivX video files with a text subtitle. DivX video files with a graphic subtitle do not use the DVD99's built-in font, so the font size cannot be adjusted.

Auto Play Mode

Use to select on or off for the disc to be automatically played when inserted.

DivX(R) VOD

Select this to display the device registration code for DivX Video on Demand service (also exits the Setup Menu). To learn more, visit: www.divx.com/vod

Speaker setup page

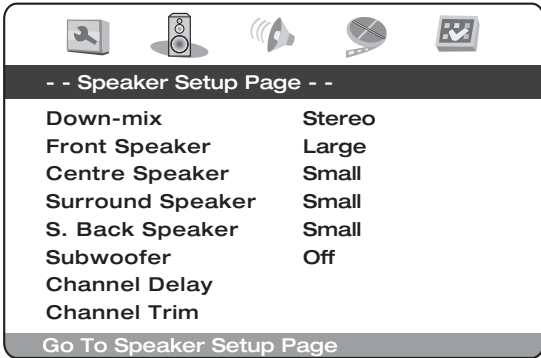

With the Speaker setup page selected, use the ▲ and ▼ buttons to move up/down to the desired sub-menu. Use the navigation arrows (▲ ▼ ◀ ▶) to adjust the settings and press the ENTER button to confirm your selection. See the following list for the Speaker setup page structure:

Menus	Settings
Down-mix	<ul style="list-style-type: none"> LT/RT Stereo V.Surround 5.1 CH 7.1 CH
Front Speaker	<ul style="list-style-type: none"> Large Small
Center Speaker	<ul style="list-style-type: none"> Large Small Off
Surround Speaker	<ul style="list-style-type: none"> Large Small Off
S. Back Speaker	<ul style="list-style-type: none"> Large Small Off
Subwoofer	<ul style="list-style-type: none"> On Off
Channel Delay	
Channel Trim	

Down-mix

Use this option to set the audio down-mix mode for converting multi-channel audio into two-channel output. This setting affects the analog and HDMI audio outputs. The options are:

LT/RT - Dolby Pro Logic II Left Total/Right Total. This mode is intended for use with two-channel Dolby Pro Logic II receivers. The center and surround channels are mixed into the two front channels according to the LT/RT matrix. A Dolby Pro Logic II receiver will decode the two-channel audio into surround audio.

Stereo - This mode down-mixes decoded multi-channel (5.1ch) audio to 2-channel stereo output. For original stereo content the output will still be stereo. For original multi-channel content the surround and center channels will be mixed with the left and right front channels. Recommended for use with TV sets or stereo receiver/amplifiers.

V. Surround - Virtual Surround. This mode creates a virtual surround effect from stereo or multi-channel audio contents.

5.1 CH - This mode enables 5.1 channel decoded audio output. The number of actual output channels depends on the disc.

7.1 CH - This mode enables 7.1 channel decoded audio output. The number of actual output channels depends on the disc. For 6.1 channel contents, the left and right surround back speakers will both output the same surround back audio channel.

In the next series of menus for each speaker type, select from 'Large' and 'Small' for each speaker ('Large' and 'Small' are used to describe each speaker in terms of bass response and do not necessarily reflect the actual physical size of the speaker).

Large = Speakers with an extended low frequency response of approximately 20-40Hz to 16-20kHz (floorstanders or high quality larger stand-mounted speakers).

Small = Speakers with a less extended low frequency response of approximately 80-100Hz to 16-20kHz (small stand-mounted, bookshelf or satellite speakers).

Setting each speaker allows the DVD99 to perform what is called Bass Management and to direct low frequency bass from music and the Low Frequency Effects channel of surround sound material away from speakers not able to reproduce it and to the subwoofer channel instead.

Front, Centre and Surround Speakers

These settings allow selection of 'Large' or 'Small' speaker 'size' as described above. If there is no center speaker, surround speakers or surround back speakers, select the 'Off' option for these speakers.

Subwoofer

Use to enable (On) /disable (Off) the subwoofer output.

Channel Delay

For best surround-sound effects it is desirable to adjust the channel delay so that sounds from each speaker arrive at the listener at the same time. This is done by measuring the distance from the listening position to the Left or Right Front speaker (which should be equidistant from the listener), distance from the listening position to the Centre Speaker and similarly to the Right Rear Speaker, Left Rear Speaker and Subwoofer. See diagram below:

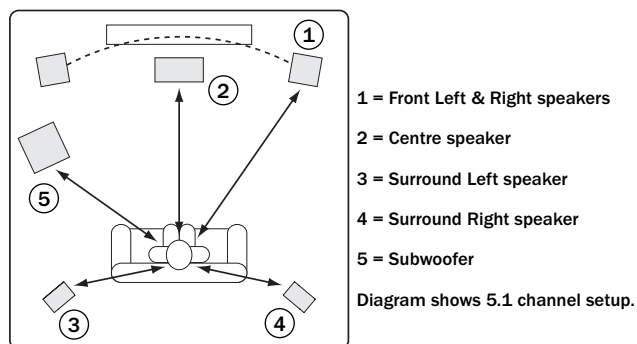

The measurements are not too critical so do not worry if your front speakers are slightly asymmetric or about making very precise measurements (+/- a foot or 30cm or so is fine).

The channel delay to be entered for each speaker is then the difference between the distance to the Front Speakers and the speaker to be configured.

So for instance if the Front Speakers are 5 ½ feet from the listener and the Centre speaker 3 feet from the listener the channel delay to be entered for the Centre Speaker is 2 ½ feet. Similarly if the Right Rear Surround is 3 ½ feet from the listener the channel delay would then be 2 feet.

Note: The distance between the surround speakers and the listener must be shorter than or equal to that between the front speakers and the listener.

The units are feet for units sold in North America / Canada and metres for units sold in Europe / Australasia.

Use ▲ ▼ to select each speaker in turn and ◀ ▶ to enter a distance value.

The DVD99 uses this to calculate and use the correct delay time for each channel so that each channel reaches the listener at the same moment.

Channel Trim

Use to set the volume of each individual channel.

Press the ◀ ▶ buttons to select the channel to be adjusted and use the ▲ ▼ buttons to raise or lower the volume of the selected channel in 0.5dB increments. Press the ENTER button to confirm the settings and return to the Audio Setup Page.

Channel trim is generally not required since most A/V receivers have the capability to adjust channel trim and compensate for speaker sensitivity differences. However if your receiver does not have such functions, you may adjust channel trim on the DVD player. For most accurate results, it is recommended that you use test tones from a calibration disc, such as AVIA Guide to Home Theater, and a SPL (Sound Pressure Level) meter.

Audio setup page

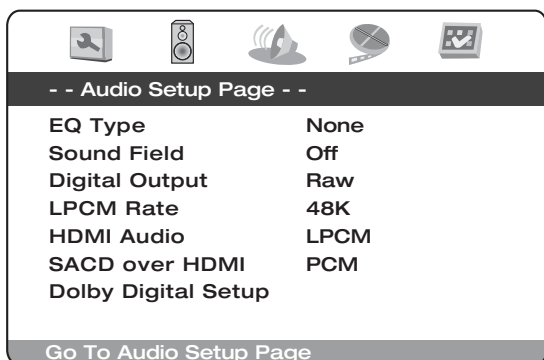

With the Audio setup page selected, use the ▲ and ▼ buttons to move up/down to the desired sub-menu. Use the navigation arrows (▲ ▼ ◀ ▶) to adjust the settings and press the ENTER button to confirm your selection. See the following list for the Audio setup page structure:

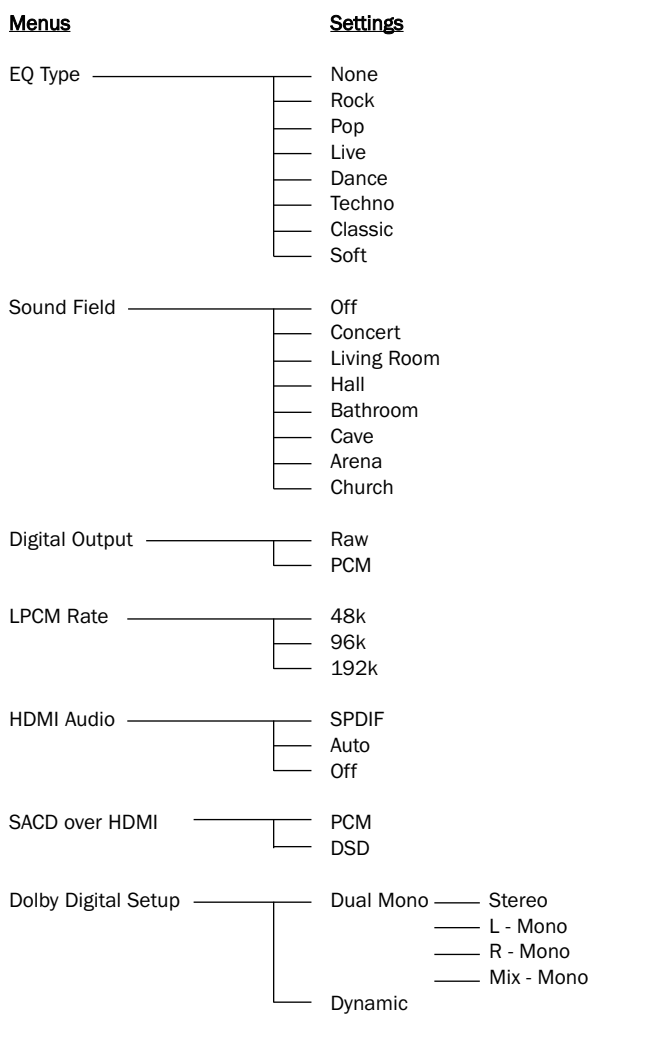

EQ Type

Use to set the equalization pattern type. Available options are: None, Rock, Pop, Live, Dance, Techno, Classic and Soft.

Sound Field

Use to set the sound field effect. Available options are: Off, Concert, Living Room, Hall, Bathroom, Cave, Arena and Church.

Digital Output

Use to set the bit stream type of the digital audio output for use with Dolby Digital and DTS-compatible receivers:

Raw – Passes the encoded multi-channel digital audio unaltered. Choose this setting if your receiver/amplifier is capable of decoding Dolby Digital and/or DTS.

PCM – Forces down-mixed 2-channel digital audio output. Choose this setting if your receiver/amplifier only supports stereo digital (PCM) audio.

LPCM Rate

Use to set the maximum Linear PCM output frequency:

48K – Supported by most equipment.

96K – Allows a higher sampling rate and frequency response. It can result in better audio quality. Ensure that the receiver/amplifier can support it.

192K – Allows the highest sampling rate and frequency response. It can result in the best audio quality. Ensure that the receiver/amplifier can support it.

HDMI Audio

Use to select digital audio output from the HDMI port:

SPDIF – Digital audio output via HDMI will be multi-channel Linear PCM format. The Down-mix setting in the "Speaker Setup Page" will affect whether and how multi-channel audio content will be down-mixed to stereo. When this option is selected, compressed audio bit streams will be decoded by the DVD player. This setting is recommended when connecting the HDMI output directly to a TV.

Auto – Digital audio output via HDMI will be the same as the digital coaxial/optical audio output for CD, Dolby Digital and DTS audio signals. For high resolution stereo or multichannel audio contents such as DVD-Audio and Super Audio CD, the DVD player will send multi-channel PCM audio signals with the highest available sample frequency and bit numbers. Depending on the original audio content, the format could be 44.1kHz - 192kHz, 2 - 8 channels. This option is recommended when connecting the HDMI output to an A/V receiver or processor with HDMI v1.1 or above audio capabilities.

Off – No digital audio output via HDMI.

Notes:

If you use HDMI to connect audio to a HDMI A/V receiver or audio processor, it is recommended that you choose 720p or higher HDMI output resolution when playing high resolution audio content (DVD-Audio and SACD). According to the HDMI specification, the bandwidth available for audio is proportional to the total bandwidth used by video. At 480p/576p resolution, the HDMI specification can only support 2 channels of audio with high sample rate (up to 192kHz), or 8 channels of audio with standard sample rate (up to 48kHz).

Depending on the capability of your A/V receiver or audio processor, if you play high resolution audio content at 480p/576p resolution, you may get reduced audio resolution, incomplete audio channels, or even no audio/video output at all. Choosing a high HDMI output resolution such as 720p or 1080i allows enough bandwidth for all high sample rate audio channels.

To get the best possible audio via HDMI, you may need to set the following options on the DVD99s setup menu, depending on your HDMI-capable receiver/display configuration:

- **No Surround Speakers (such as a TV):** If the receiver or TV does not have surround speakers, please set the Speaker Setup Page > Down-mix to "Stereo" or "V. Surround". Also set the Audio Setup Page > HDMI Audio to "Multi-Channel". Alternatively, you may set Audio Setup Page > HDMI Audio to "SPDIF" and Audio Setup Page > SPDIF Output to "PCM".
- **Surround and Dolby Digital or DTS Support, or HDMI 1.0:** If the audio system has surround speakers and can support Dolby Digital or DTS with its HDMI input, please set Audio Setup Page > HDMI Audio to "SPDIF" AND Audio Setup Page > SPDIF Output to "Raw". In this case your audio system will perform decoding for Dolby Digital or DTS surround audio. Unfortunately the HDMI standard does not allow DVD-Audio or SACD to be sent over HDMI in this configuration.

SACD over HDMI

Use to set the relevant HDMI version that your receiver supports

PCM – Forces down-mixed 2-channel digital audio output. Choose this setting if your receiver/amplifier only supports stereo digital (PCM) audio.

DSD – (Direct-Stream Digital) is the trademark name used by Sony and Philips for their system of recreating audible frequencies which uses pulse-density modulation encoding, a technology to store audio signals on digital storage media which is used for the Super Audio CD (SACD).

Dolby Digital Setup

To configure the Dolby Digital decoder. Press the ENTER button to enter the Dolby Digital Setup page (use the ◀ button to exit).

A. Dual Mono

Choose the output for Dolby Digital discs encoded with two independent audio channels, such as bilingual programs. The options are:

Stereo – Stereo output

L-Mono – Left channel output to both Left and Right speakers.

R-Mono – Right channel output to both Left and Right speakers.

Mix Mono – Left and Right channels mixed to both Left and Right speakers.

B. Dynamic

Use to set the Dynamic Range Compression (DRC). DRC can smooth out the sonic peaks and valleys common with wide-range digital audio. Increasing DRC may make low level audio more audible during low-level listening. Decreasing or turning off DRC restores the sonic energy present in the original recording.

Video setup page

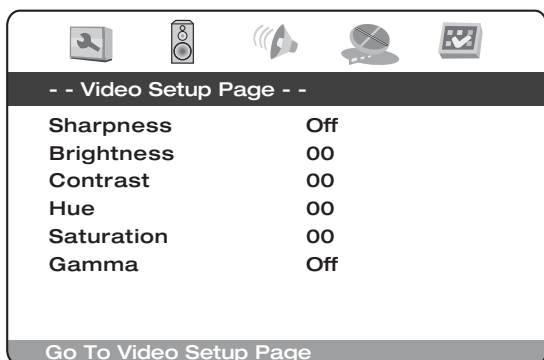

With the Video setup page selected, use the ▲ and ▼ buttons to move up/down to the desired sub-menu. Use the navigation arrows (▲ ▼ ◀ ▶) to adjust the settings and press the ENTER button to confirm your selection. See the following list for the Video setup page structure:

Menus

Settings

Sharpness	—	Sharp
	—	Soft
	—	Off
Brightness		
Contrast		
Hue		
Saturation		
Gamma	—	High
	—	Medium
	—	Low
	—	Off

Sharpness

Use to set the sharpness of video output:

Sharp – Enable edge enhancement. Video details are the sharper. May cause slight white line etching around objects.

Soft – Soften edges. Video appears to be smoother but may cause slight loss of details.

Off (Recommended) – Turn off edge enhancement completely.

Note: Sharpness (edge enhancement) is an artificial video processing function that can produce a sharper looking picture but at the same time may degrade the details of the picture or cause unwanted artifacts. We generally recommend leaving it off.

Brightness

Use to adjust the brightness (black level) of the video output. Press the ENTER button to show the Brightness scale, and then use the ◀ ▶ buttons to adjust. Press the ENTER button to confirm the new setting.

Contrast

Use to adjust the contrast (white level) of the video output.

Note: The ability to set brightness and contrast is no small thing. If you do not have the correct black and white levels then your images can appear washed out or you won't be able to see into the shadows when watching darker scenes in movies. Televisions have brightness (black level) and contrast (white level) controls; however it may take a combination of tweaking both the DVD player and your television to get just the right result. We recommend using a calibration DVD like AVIA Guide to Home Theater or Digital Video Essentials and setting your display for the best possible picture. Once that is done, see if changing the DVD player settings can get you even closer to the optimal picture.

Hue

Use to adjust the hue (tint) of the video output.

Saturation

Use to adjust the saturation (colour intensity level) of the video output.

Gamma

Use to adjust the Gamma (intensity distribution to video signal level) of the video output. The available settings are High, Medium, Low and Off.

Preference page

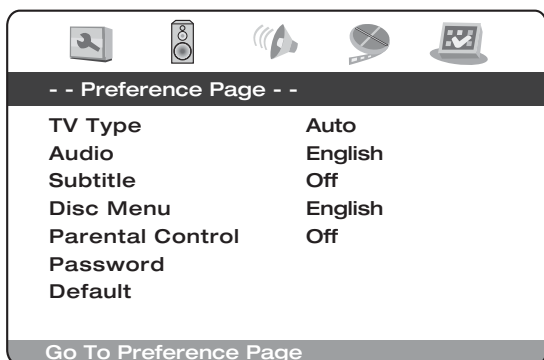

Note: To access the Preference menu, the disc tray drawer must be open or when the disc is completely stopped.

The Preferences menus are used to set the default language tracks the DVD99 will use for Soundtrack, Subtitles and Disc Menu if they are available on the disc. The DVD99 will automatically select the appropriate language from those available on the disc where possible.

Also it is possible to restrict the type of disc able to be played back via the Parental control menu item.

With the Preference page selected, use the ▲ and ▼ buttons to move up/down to the desired sub-menu. Use the navigation arrows (▲ ▼ ◀ ▶) to adjust the settings and press the ENTER button to confirm your selection. See the following list for the Preference page structure:

Menus	Settings
TV Type	Auto PAL NTSC
Audio	English French Spanish Chinese Japanese Korean Russian Thai Other
Subtitle	English French Spanish Chinese Japanese Korean Russian Thai Other Off Auto
Disc Menu	English French Spanish Chinese Japanese Korean Russian Thai Other

Parental Control	1 Kid 2 G 3 PG 4 PG 13 5 PG R 6 R 7 NC 17 8 Adult Off
Password	Change
Default	Reset

TV Type

Use to set the output video system (PAL/NTSC) to match the type of TV:

Auto (default) – No system conversion is performed. The output video system is the same as that encoded on the disc. Requires TV that supports multi-systems.

PAL – When playing PAL-encoded discs, no system conversion is performed. NTSC encoded contents are converted to PAL output.

NTSC – When playing NTSC-encoded discs, no system conversion is performed. PAL encoded contents are converted to NTSC output.

Audio

Use this to set the default soundtrack language of the DVD disc to be played.

Subtitle

Use this to set the default language of the subtitles displayed on the TV.

Disc Menu

Use this to set the default language of the menus in the disc top menu.

Parental

Use this to restrict the playback of adult rated DVDs you do not want children to view. Select the rating level you do not want to be accessed and press ENTER. Discs with this rating and higher will now not be able to be played without a password.

Note: Viewing cannot be restricted unless the restriction level is recorded on the disc. Discs without a restriction level encoded will still be accessible.

Password

Use this to change the password. The unit's default password is 7890.

Default

Select 'Default' and press the ENTER button to restore the DVD player to it's factory default settings.

Note: All settings previously set by the user will be lost!

Basic operating instructions

Getting started

Turn on the power of the TV, amplifier/AV receiver and any other components which are connected to the DVD player. Make sure the TV and the audio receiver are set to the correct input channel.

1. Press the *Open/Close* button to open the disc tray.
2. Place the disc on the tray, label side facing up.
3. Press the *Play/Pause* button. The tray will automatically close and playback will begin.

For CDs playback will begin straight away at track 1. For DVDs, normally the disc will go to the Title Menu which is the main menu recorded on the DVD itself. This is where various disc options will be presented on screen depending on the disc.

DVDs are normally split into one or more Titles, each subdivided into Chapters. Each Title may also have alternative soundtracks and subtitles available. From the Title Menu it is normally possible to start playback of the main film, go directly to different chapters or access special features.

Examples of special features are alternative soundtracks (Stereo or DD 5.1 for instance, perhaps DTS 5.1, also commentaries and different language versions of the soundtrack) and subtitles. Also more than one title may be available (different versions of the film or making-of featurettes for instance). These features are encoded on the disc and the options presented are entirely disc dependant.

Move around the options using the *Navigation arrows* (▲ ▼ ◀ ▶), select the option that starts the film playing in the version you want and press *Enter*.

4. Press the *Stop* button at anytime to stop playback.

Note:

- Do not put anything except a DVD/CD sized disc into the tray, foreign objects may damage the mechanism.
- Do not force the tray by hand during the opening and closing operations.
- To avoid dirt and dust entering the mechanism, keep the disc tray closed when not in use.
- If the disc is seriously scratched or too dirty the player may not be able to read it or play it.
- Never load more than one disc into the disc tray at one time.

Skip playback

1. Press **▶▶** once to skip forward by one track/chapter on the disc. Press and hold to skip forwards through several tracks.
2. Press **◀◀** once to skip backward by one track/chapter on the disc. Press and hold to skip backwards through several tracks.

Go To

Press the *Go To* button on the remote once to access Chapter Selection then enter the required chapter via the numerical buttons. Press twice to access Disc Time Selection and enter the required time from the start of the disc as H:MM:SS (Hours, Minutes, Seconds). Press three times to access Chapter Time Selection and enter the required time from the start of the chapter.

Fast Forward/Rewind search

Press repeatedly to cycle between 2X, 4X, 8X, 16X and 32 playback speed (without sound) and back to normal playback. Press **◀◀** button for backwards playback options, or the **▶▶** button for forwards playback.

Slow

When playing a DVD, press repeatedly to cycle round the various speeds of slow motion (1/2, 1/4, 1/8 and 1/16), forwards and backwards and back to normal speed.

Repeat

Note: The Repeat function is available only during playback.

Press the *Repeat* button on the remote to repeatedly play a single chapter/title on a DVD video or a single track/entire disc on a CD.

The first press selects chapter/track repeat, the second press selects title/disc repeat, the third press selects All repeat.

Note: The repeat chapter/title setting will be cleared when moving to other chapter or title.

A-B Repeat

1. Press the A-B button at your desired starting point. 'A' appears briefly on the TV screen.
2. Press the A-B button at your desired end point. 'A-B' appears briefly on the TV screen, and the repeat sequence begins.
3. To exit the sequence, press the A-B button.

Note:

- The A-B repeat section can only be set within the current title (for DVD video) or current track (for DVD audio, Video CD and Audio CD).
- A-B repeat playback is not available with some scenes on DVD.
- A-B repeat playback does not function during title, chapter, track or all repeat playback.

During DVD playback it is also possible to access soundtracks, subtitles and angles (where present on the disc) without having to go back to the Title Menu or stopping playback. Use the following remote control buttons:

Audio

Press to directly access alternate audio soundtracks on the DVD (if available on the DVD disc).

Subtitle

Press to enable/disable Subtitles (if available on the DVD disc).

Angle

Press to access various camera angles (if available on the DVD disc).

Zoom

Press to cycle through the various zoom magnifications (and back to normal display).

MPEG4 Playback

The MPEG4 is the standard publicised by MPEG4 (Moving Picture Experts Group). MPEG4 allows video and audio to be compressed to a fraction of its original size.

With a scalable bitstream, it can be adapted to dynamically varying requirements.

PC-created disc compatibility

Discs created using a computer may not be playable in this unit due to the setting of the application software used to create the disc. In these particular instances, check with the software publisher for more detailed information.

Discs recorded in packet write mode (UDF format) are not compatible with this player. Check the DVD-R/RW or CD-R/RW software disc boxes for additional compatibility information.

Note: DivX version is still upgrading continuously and the latest version of this unit is DivX 6.7. Some discs labelled with MPEG4 on the market actually are *.rm/*.ram/*.rmm and others which are incompatible. Please take care when buying discs.

Playing MPEG4 Files

When you insert a MPEG4 disc, the TV screen displays the operation menu as shown in Figure A (the displayed contents vary with the disc.)

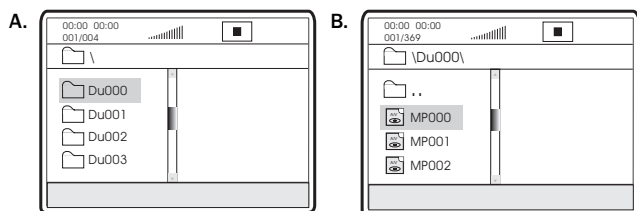

Press UP/DOWN arrows to select the desired directory. Press SELECT for verification. For example, you select the directory DU000 in Figure A and press SELECT as shown in Figure B.

The window returns back to the Press UP/DOWN arrows to select the desired directory. Press SELECT for verification. For example, you select the directory DU000 in Figure A and press SELECT as shown in Figure B. The window returns back to the previous directory when you select [⏪] in the first line or press LEFT arrow.

Press UP/DOWN arrows in Figure B to select the desired MPEG4 file. Press SELECT for verification. The player will then play the MPEG4 files.

Info menu

Pressing the Info button brings up the menu shown below:

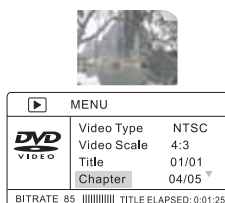

Note: This display may vary due to the formatting and programming of your DVD disc.

This enables you to conveniently perform several DVD disc functions of title, chapter, sound, subtitle, angle, title time, chapter time, repeat play and time display. Use the navigation and select keys on the remote control to navigate through the menu.

Pressing the Info button again takes you back to full screen video.

DVD Audio

Using MLP lossless from Dolby Laboratories. DVD-Audio discs can store up to six channels of 24-bit/96 kHz audio, including a separate low-frequency bass channel. Compare that to two channels of 16-bit/44.1 kHz sound from CD's! For stereo buffs, a DVD-Audio disc can alternatively hold two channels of 24-bit/192 kHz audio, exceeding the quality of any music audio format previously available.

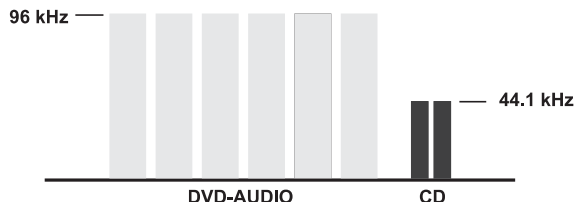

DVD-Audio discs can also add a visual element to your music. Discs can carry picture galleries, lyrics, notes, or any combination of still images, animation, and text. Producers and artists can even add audio commentary, similar to that found on many DVD-Video discs. And, as with DVD-Video, each DVD-Audio disc can also contain full-motion video, with accompanying Dolby Digital sound in up to 5.1 channels.

SACD or DVD-Audio Playback

To utilise SACD or DVD-Audio* you will also need to connect six (6) analogue RCA-style cables from the DVD99 to your receiver's multi-channel analogue inputs. These multi-channel outputs will also support playback of DVD-Audio, Dolby Digital and stereo sources. Here are some general notes and guidelines to following depending upon what formats you intend to play:

No DVD-Audio or SACD - Use HDMI or one of the digital cable connection choices if you do not intend to use SACDs or DVD-Audio discs in your system.

DVD-Audio But No SACD - Use HDMI if you have a receiver that handles HDMI audio and multichannel outputs if you do not. To do this you must have a receiver with available multi-channel inputs. Set the Speaker Setup Page > Down-mix to "5.1CH".

DVD-Audio and SACD - Use HDMI if you have a receiver that handles HDMI audio and the analogue audio outputs for SACD. To do this you must have a receiver with available multi-channel inputs. Set the Speaker Setup Page > Down-mix to "5.1CH".

*DVD-Audio and SACD (DSD converted to PCM) can also be played back via HDMI to a receiver which supports HDMI 1.1 audio. "DVD-Audio" is a high resolution PCM-based format and is not to be confused with the Dolby Digital or DTS audio found on normal DVDs.

Language code list

Code	Language name	Code	Language name	Code	Language name
6565	Afar	7285	Hungarian	8084	Portuguese
6566	Abkhazian	7289	Armenian	8185	Quechua
6570	Afrikaans	7365	Interlingua	8277	Rhaeto-Romance
6577	Ameharic	7378	Indonesian	8279	Romanian
6582	Arabic	7383	Icelandic	8285	Russian
6583	Assamese	7384	Italian	8365	Sanskrit
6588	Aymara	7387	Hebrew	8368	Sindhi
6590	Azerbaijani	7465	Japanese	8372	Serbo-Croatian
6665	Bashkir	7473	Yiddish	8373	Singhalese
6669	Byelorussian	7487	Javanese	8375	Slovak
6671	Bulgarian	7565	Georgian	8376	Slovenian
6672	Bihari	7575	Kazakh	8377	Samoa
6678	Bengali, Bangla	7576	Greenlandic	8378	Shona
6679	Tibetan	7577	Cambodian	8379	Somali
6682	Breton	7578	Kannada	8381	Albanian
6765	Catalan	7579	Korean	8382	Serbian
6779	Corsican	7583	Kashmiri	8385	Sundanese
6783	Czech	7585	Kurdish	8386	Swedish
6789	Welsh	7589	Kirghiz	8387	Swahili
6865	Danish	7665	Latin	8465	Tamil
6869	German	7678	Lingala	8469	Telugu
6890	Bhutani	7679	Laothian	8471	Tajik
6976	Greek	7684	Lithuanian	8472	Thai
6978	English	7686	Latvian, Lettish	8473	Tigrinya
6979	Esperanto	7771	Malagasy	8475	Turkmen
6983	Spanish	7773	Maori	8476	Tagalog
6984	Estonian	7775	Macedonian	8479	Tonga
6985	Basque	7776	Malayalam	8482	Turkish
7065	Persian	7778	Mongolian	8484	Tatar
7073	Finnish	7779	Moldavian	8487	Twi
7074	Fiji	7782	Marathi	8575	Ukrainian
7079	Faroese	7783	Malay	8582	Urdu
7082	French	7784	Maltese	8590	Uzbek
7089	Frisian	7789	Burmese	8673	Vietnamese
7165	Irish	7865	Nauru	8679	Volapuk
7168	Scots Gaelic	7869	Nepali	8779	Wolof
7176	Galician	7876	Dutch	8872	Xhosa
7178	Guarani	7879	Norwegian	8979	Yoruba
7185	Gujarati	7982	Oriya	9072	Chinese
7265	Hausa	8065	Panjabi	9085	Zulu
7273	Hindi	8076	Polish		
7282	Croatian	8083	Pashto, Pushto		

Technical specifications

Disc types	CD (CD-DA), SACD, DVD-A, DVD-V, CD-R/RW, DVD-R/RW, DVD+R/RW, DivX, MP4
Analog audio outputs	<ul style="list-style-type: none"> • Stereo • 5.1 (from DVD, DVDA and SACD multi-channel) • 7.1 (from DD)
Analog video outputs	<ul style="list-style-type: none"> • Composite Video (CVBS) • S-Video (SVHS) • RGB/SCART • Component (YCbCr/YPbPr)
HDMI output	Scaling/Deinterlacing to 480i/p, 576i/p, 720p, 1080i/p
THD (unweighted)	< 0.002% @ 1kHz < 0.008% @ 20Hz - 20kHz
IMD (19/20kHz) 0dBFs	< 0.002%
S/N ratio	< -103dB
Crosstalk @1kHz	< -103dB @ 1kHz
Dynamic Range	> 105dB
Frequency response	5Hz - 20kHz ± 0.2dB
Jitter (correlated)	< 140 psec
Composite Video	1.0V pk-pk (75 ohms)
S-Video	Y: 1.0V pk-pk (75 ohms) C: 0.286V pk-pk (75 ohms)
Component Video	Y: 1.0V pk-pk (75 ohms) Cb/Cr: 0.75V pk-pk (75 ohms) Pb/Pr: 0.75V pk-pk (75 ohms)
Power supply	100-240V AC ~ 50/60Hz
Max power consumption	40W
Dimensions (H x W x D)	55 x 430 x 263mm
Weight	2.6kg (5.7Lbs)

Cambridge Audio's policy is one of continuous improvement. Design and specifications are therefore subject to change without prior notice.

Troubleshooting

There is no power

Ensure the AC power cord is connected securely.
Ensure the plug is fully inserted into the wall socket and is switched on.
Check fuse in the mains plug or adaptor.

The player will not read the disc

Check the disc is not loaded upside down.
Check that the disc is not too scratched or dirty.
The disc type is not supported by this unit.
Functions on some discs may not work on this unit. This is not a malfunction of the DVD player.

There is no sound

Ensure that the amplifier is set correctly.
Check that the interconnects are inserted correctly.

The disc is skipping

Check that the disc is not too scratched or dirty.
Ensure the player is on a firm surface and not subject to vibrations.

A low hum or buzz sound can be heard

Power cords or lighting placed near this product.
Analog inputs not connected securely.

No sound from the rear speakers

Source being played is not recorded in surround-sound.
A stereo mode has been selected.

No sound from the centre speaker

A stereo mode has been selected.

Remote control is not working

The batteries are flat.
The remote is too far from the unit or out of the effective range.

Files on a connected USB device do not play

If the USB drive is incompatible, or the player encounters errors while reading the USB drive or flash memory card, the screen displays "Device Error". In this case please verify that the USB drive is compatible, and try to unplug the device and re-insert again.

In some cases, an incompatible USB device may cause the player to stop responding. If this occurs simply turn off the power, remove the USB device, and turn the player back on.

Problems using HDMI

Ensure that your screen supports HDCP (High-Definition Copy Protection).

Ensure your screen is capable of displaying the resolution being output by the DVD player.

Note: Cables which run over 5m may cause sync or grounding issues.

For more frequently asked questions (FAQ's), technical advice and information on getting the most out of your DVD99, please visit the Support section on Cambridge Audio's website:

www.cambridgeaudio.com/support.php

Cambridge Audio is a brand of Audio Partnership Plc

Registered Office: Gallery Court, Hankey Place,

London, SE1 4BB, United Kingdom

Registered in England No. 2953313

www.cambridge-audio.com

