

# azur 840A

---

Class XD Integrated Amplifier

User's Manual



*Cambridge Audio*

## CONTENTS

Introduction .....	3
Safety precautions .....	4
Important safety instructions .....	5
Rear panel connections.....	6
Front panel controls.....	8
Remote control.....	10
Connections .....	11
Operating instructions .....	14
Amplifier setup.....	15
Multi-Room .....	18
Custom installation use.....	19
CAP5 protection system .....	20
Troubleshooting.....	22
Technical specifications .....	23
Limited warranty .....	24

## INTRODUCTION

**Thank you for purchasing this Azur 840A Class XD Integrated Amplifier. This unit is part of our new '8' Series taking Cambridge Audio to new levels of audio excellence as part of our commitment to the on-going development of the Azur range. We hope that you will appreciate the results and enjoy many years of listening pleasure from it.**

For the 840A we developed many new circuits and components, with many parts being designed specifically for this model. A unique proprietary to Cambridge Audio patent pending amplifier topology has even been developed called Class XD™ which can eliminate crossover distortion at low signal levels.

This technology creates a region of pure Class-A operation where the crossover zone would otherwise be. It should not be confused with Class AB, which gives a small area of Class A, at the cost of higher distortion as soon as signal levels moves outside it. Class XD circuitry not only removes crossover distortion from the zero-crossing point but also reduces distortion in the other parts of the amplifier's output range. A white paper on this technology is available on our website: [www.cambridge-audio.com](http://www.cambridge-audio.com).

Please note that because of the Class XD technology the 840A runs slightly warmer than a conventional Class B/AB amplifier and the ventilation slots on the top of the unit must not be obscured.

Other features include the use of precision networks of resistors and relays for the volume and balance control rather than the more common solid-state or volume potentiometer schemes. Volume is controllable in 1 dB steps over most of the range, giving very fine control, an accurate logarithmic law and superbly accurate channel balance. Input switching is also by high quality relays.

The 840A features separate transformer secondaries for left and right channels, twin rectifiers and separate PSU's for dual mono operation of the left and right power amplifiers. A separate transformer supplies the preamp making the 840A effectively a Pre and Power amp combination in one box.

Input 1 features a balanced input using XLRs giving optimal performance with equipment such as the matching 840C Upsampling CD player which feature balanced outputs.

A completely new casework has been designed which combines massive structural rigidity with careful damping and control of acoustic resonance. An Azur Navigator remote control is also provided, giving full remote control of your amplifier in an attractive and easy to use handset.

We have also added many new features, including support for multi-room use. By plugging in one or two external Cambridge Audio Incognito keypads and a power supply unit your amplifier can become the hub of a simple multi-room system. In addition, Control Bus Input/Output, IR Emitter Input and RS232 control are provided to make it easy to integrate this unit into Custom Installation systems if desired.

Your amplifier can only be as good as the system it is connected to. Please do not compromise on your source equipment, speakers or cabling. Naturally we particularly recommend models from the Cambridge Audio Azur range. These have been designed to the same exacting standards as this amplifier. Your dealer can also supply excellent quality Cambridge Audio interconnects to ensure your system realises its full potential.

Thanks for taking the time to read this manual; we do recommend you keep it for future reference.

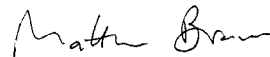

Matthew Bramble  
Technical Director

## SAFETY PRECAUTIONS

### Checking the Power Supply Rating

For your own safety please read the following instructions carefully before attempting to connect this unit to the mains.

Check that the rear of your unit indicates the correct supply voltage. If your mains supply voltage is different, consult your dealer.

This unit is designed to operate only on the supply voltage and type that is indicated on the rear panel of the unit. Connecting to other power sources may damage the unit.

This equipment must be switched off when not in use and must not be used unless correctly earthed. To reduce the risk of electric shock, do not remove the unit's cover (or back). There are no user serviceable parts inside. Refer servicing to qualified service personnel. If the power cord is fitted with a moulded mains plug the unit must not be used if the plastic fuse carrier is not in place. Should you lose the fuse carrier the correct part must be reordered from your Cambridge Audio dealer.

The lightning flash with the arrowhead symbol within an equilateral triangle is intended to alert the user to the presence of un-insulated 'dangerous voltage' within the product's enclosure that may be of sufficient magnitude to constitute a risk of electric shock to persons.



The exclamation point within an equilateral triangle is intended to alert the user to the presence of important operating and maintenance instructions in the service literature relevant to this appliance.

This product complies with European Low Voltage (73/23/EEC) and Electromagnetic Compatibility (89/336/EEC) Directives when used and installed according to this instruction manual. For continued compliance only Cambridge Audio accessories should be used with this product and servicing must be referred to qualified service personnel.



The crossed-out wheeled bin is the European Union symbol for indicating separate collection for electrical and electronic equipment. This product contains electrical and electronic equipment which should be reused, recycled or recovered and should not be disposed of with unsorted regular waste. Please return the unit or contact the authorised dealer from whom you purchased this product for more information.



### Plug Fitting Instructions (UK Only)

The cord supplied with this appliance is factory fitted with a 13 amp mains plug fitted with a 3 amp fuse inside. If it is necessary to change the fuse, it is important that a 3 amp one is used. If the plug needs to be changed because it is not suitable for your socket, or becomes damaged, it should be cut off and an appropriate plug fitted following the wiring instructions below. The plug must then be disposed of safely, as insertion into a 13 amp socket is likely to cause an electrical hazard. Should it be necessary to fit a 3-pin BS mains plug to the power cord the wires should be fitted as shown in this diagram. The colours of the wires in the mains lead of this appliance may not correspond with the coloured markings identifying the terminals in your plug. Connect them as follows:

The wire which is coloured BLUE must be connected to the terminal which is marked with the letter 'N' or coloured BLACK.

The wire which is coloured BROWN must be connected to the terminal which is marked with the letter 'L' or coloured RED.

The wire which is coloured GREEN/YELLOW must be connected to the terminal which is marked with the letter 'E' or coloured GREEN.

If your model does not have an earth wire, then disregard this instruction.

If a 13amp (BS 1363) plug is used, a 3amp fuse must be fitted, or if any other type of plug is used a 3amp or 5amp fuse must be fitted, either in the plug or adaptor, or on the distribution board.

## IMPORTANT SAFETY INSTRUCTIONS

Please take a moment to read these notes before installing your Azur amplifier, they will enable you to get the best performance and prolong the life of the product. We advise you follow all instructions, heed all warnings and keep the instructions for future reference.

The unit is of Class 1 construction and must be connected to a Mains socket outlet with a protective earthing connection.

Only use the specified attachments/accessories with this unit.

Do not defeat the safety purpose of the polarized or grounding type plug. A polarized plug has two blades with one wider than the other. A grounding type plug has two blades and a third grounding prong. The wide blade or third prong are provided for your safety. If the provided plug does not fit your outlet, consult an electrician for replacement of the obsolete outlet.

The unit must be installed in a manner that makes disconnection of the mains plug from the mains socket outlet (or appliance connector from the rear of the unit) possible. Where the mains plug is used as the disconnect device, the disconnect device shall remain readily operable. Protect the power cord from being walked on or pinched particularly at plugs, convenience receptacles, and the point where they exit from the unit.

This unit must be installed on a sturdy, level surface. Do not place in a sealed area such as a bookcase or in a cabinet. Any space open at the back (such as a dedicated equipment rack) is fine however. When a cart is used, use caution when moving the cart to avoid injury from tip-over.



Please ensure there is ample ventilation (at least 10cm clearance all round). Do not put any objects on top of this unit. Do not situate it on a rug or other soft surface and do not obstruct any air inlets or outlet grilles. Do not install near any heat sources such as radiators, heat registers, stoves, or other apparatus (including amplifiers) that produce

heat. Do not stack multiple units on top of each other. Do not place in an enclosed area such as a bookcase or in a cabinet without sufficient ventilation.

**WARNING** - To reduce the risk of fire or electric shock, do not expose this unit to rain or moisture. This unit must not be used near water or exposed to dripping or splashing water or other liquids. No objects filled with liquid, such as vases, shall be placed on the unit. In the event, switch off immediately, disconnect from the mains supply and contact your dealer for advice.

Ensure that small objects do not fall through any ventilation grille. If this happens, switch off immediately, disconnect from the mains supply and contact your dealer for advice.

To turn the unit off completely switch off on the rear panel. If you do not intend to use this unit for a long period of time, unplug it from the mains socket. Unplug this unit during lightning storms.

To clean the unit, wipe its case with a dry, lint-free cloth. Do not use any cleaning fluids containing alcohol, ammonia or abrasives. Do not spray an aerosol at or near the amplifier.

This unit is not user serviceable, never attempt to repair, disassemble or reconstruct the unit if there seems to be a problem. Servicing is required when the unit has been damaged in any way, such as power-supply cord or plug is damaged, liquid has been spilled or objects have fallen into it, the unit has been exposed to rain or moisture, does not operate normally or has been dropped. A serious electric shock could result if this precautionary measure is ignored.

This unit should be installed on a sturdy, level surface. Due to stray magnetic fields turntables or CRT TV's should not be located nearby due to possible interference.

## REAR PANEL CONNECTIONS

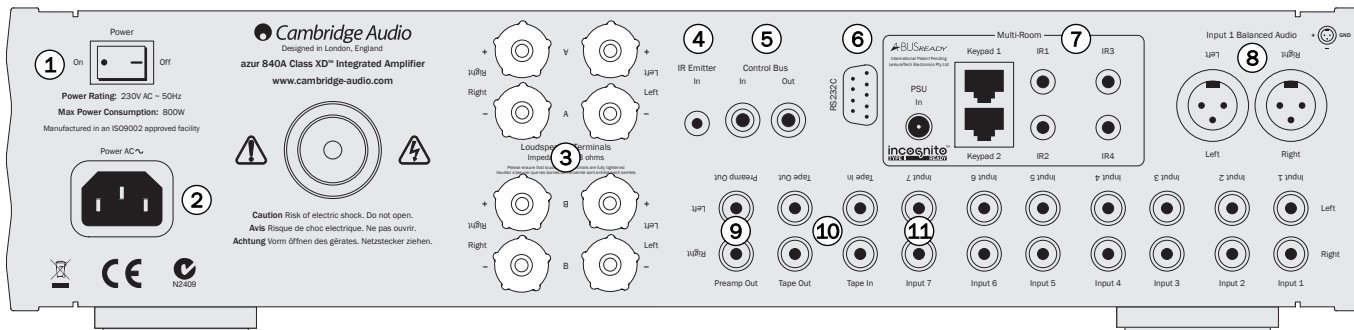

### ① Power On/Off

Switches the unit on and off.

### ② AC power socket

Once you have completed all connections to the amplifier, plug the AC power cable into an appropriate mains socket then switch on. Your amplifier is now ready for use.

### ③ Loudspeaker terminals

Two sets of loudspeaker terminals are available, **A** (main loudspeaker terminals) and **B** (secondary loudspeaker terminals). Both sets of speakers can be turned on and off. Connect the wires from your left channel loudspeaker to the LEFT + & - terminals, and the wires from the right channel loudspeaker to the RIGHT + & - terminals. In each case, the red terminal is the positive output and the black terminal is the negative output.

Care should be taken to ensure no stray strands of wire short the speaker

### ⑥ Azur Class XD integrated amplifier

outputs together. Please ensure that the loudspeaker terminals have been tightened completely to provide a good electrical connection. It is possible for the sound quality to be affected if the screw terminals are loose.

**Note:** When using one pair of speakers, use speakers with a nominal impedance of between 4-8 ohms. When using two pairs of speakers, use speakers with a nominal impedance of between 6-8 ohms.

### ④ IR (Infrared) Emitter In

Allows modulated IR commands from multi-room systems to be received by the amplifier. Commands received here are not looped out of the Control Bus. Refer to the 'Custom Installation' section for more information.

### ⑤ Control Bus

**In** - Allows un-modulated commands from multi-rooms systems or other components to be received by the unit.

**Out** - Loop out for control bus commands to another unit. Also allows the 840A to control some Cambridge Audio units.

## ⑥ RS232C

The RS232C port allows external serial control of the 840A for custom install use. A full command set is available on the Cambridge Audio website at [www.cambridge-audio.com](http://www.cambridge-audio.com). This port can also be used by Cambridge Audio service personnel for software updates.

## ⑦ A-BUS™ Ready/Incognito Ready™ multi-room outputs

**PSU** - Connect an Incognito PS10 to supply power to the connected multi-room keypads/speakers.

**Keypad 1/2** - Connect one or two Incognito A-BUS KP10 keypads (or other A-BUS compatible keypads) using CAT5/5e cable. Incognito AS10 Active Ceiling Speakers can also be connected here.

**IR** - Four IR outputs for remote control of source equipment.

Please refer to the 'Multi-Room' section of this manual for more information on connections and set-ups.

## ⑧ Input 1 Balanced Audio

Input 1 features either unbalanced (phono/RCA) or balanced (XLR) connections. Either type may be used but not both at the same time. The balanced connection is the higher quality option and can reject noise and interference in the cable when used with other equipment that supports this function. An XLR connector is wired Pin 1 - Ground; Pin 2 - Hot (in-phase); Pin 3 - Cold (phase-inverted).

When using either the balanced or unbalanced input, make sure that no cables or equipment are connected to the unused input, as this may degrade operation. The unused input does not require to be terminated and this should not be done.

## ⑨ Preamp Out

Connect these sockets to the inputs on an external power amplifier(s) or active subwoofers etc.

## ⑩ Tape In/Out

Connect to a tape deck or to the analog output sockets on a MiniDisc, portable digital music player or CD recorder using an interconnect cable from the recorder's Line Out sockets to the amplifier's Tape In sockets.

The Tape Input circuit of the 840A is a "monitor" type, different from the other 7 inputs. For the 7 normal inputs, the source selected for listening to will be sent out of the Tape Out for recording. The source currently being listened to and (optionally) recorded is then shown on the front panel display.

However, when the Tape Input is selected a solid circle will appear beside TAPE MON indicating that the Tape Input is now being listened to with a different source being sent out of the Tape Out for recording. The recording source is also shown by a solid circle by the selected input and can be changed by pressing the other source buttons. To switch Tape Monitor off, simply press the Tape Mon input select button again, toggling this function off.

This feature is most useful when using 3-head analog cassette decks which allow the signal being recorded to be played back live off tape (via a 3rd head) whilst it is simultaneously recorded. It is then possible by toggling the Tape Monitor input on and off to compare directly in real time the original and recorded signal so that adjustments to the recording parameters of the tape machine can be made (consult the manual of your 3-head analog cassette deck for full details).

## ⑪ Inputs 1-7

These inputs are suitable for any 'line level' source equipment such as CD players, DAB or FM/AM tuners etc.

**Note:** These inputs are for analog audio signals only. They should not be connected to the digital output of a CD player or any other digital device.

## FRONT PANEL CONTROLS

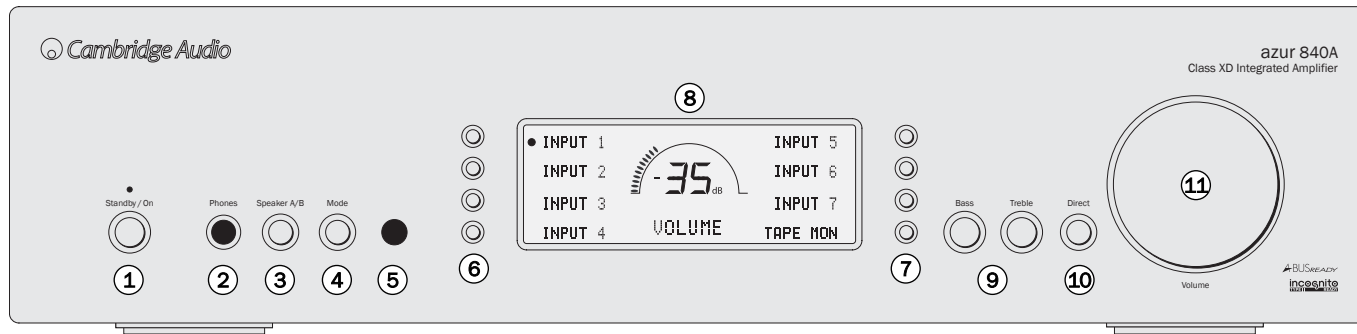

### ① Standby/On

Switches the unit between Standby mode (indicated by dim power LED) and On (indicated by bright power LED). Standby is a low power mode where the power consumption is less than 10 Watts. The unit should be left in Standby mode when not in use.

### ② Phones

Allows for the connection of stereo headphones with a ¼" Jack plug. Headphones with an impedance of between 32 and 600 ohms are recommended. When the headphones are connected, the loudspeaker relays are released switching off the output to the loudspeakers (speakers A and B).

### ③ Speaker A/B

Press to scroll through the speaker sets connected to the loudspeaker terminals on the back panel (speaker sets A, B or A and B). This can be used for listening to an extra set of loudspeakers in another room.

Please note that care should be taken when choosing speakers if two loudspeakers are going to be used on each channel. If the combined resistance measured on the loudspeaker terminals is too low the amplifier may not switch out of Standby mode until a suitable load resistance is detected. For more information refer to the CAP5 section of this manual.

**Note:** When using one pair of speakers, use speakers with a nominal impedance of between 4-8 ohms. When using two pairs of speakers, use speakers with a nominal impedance of between 6-8 ohms each.



## ④ Mode

Press to switch between Volume and Balance modes. Press and hold to enter the 840A system configure menu.

## ⑤ Infrared sensor

Receives IR commands from the supplied Azur remote control. A clear unobstructed line of sight between the remote control and the sensor is required.

## ⑥ & ⑦ Input select buttons

Push the appropriate input selection button to select the source component that you wish to listen to (highlighted by a solid circle on the display). The signal selected is also fed to the Tape Out sockets so that it may be recorded. The input should not be changed whilst recording (but the recorded signal can be checked using the tape input Tape Monitor).

## ⑧ Display

LCD used to control the 840A. Please refer to the 'Operating instructions' and 'Amplifier setup' section of this manual for more information.

## ⑨ Bass and Treble

Press to release and rotate to allow subtle adjustments to the tonal balance of the sound.

## ⑩ Direct

This control gives the audio signal a more direct path to the power amplifier stage of your amplifier, bypassing the tone control circuits for the purest possible sound quality.

## ⑪ Volume

Use to increase/decrease the level of the sound from the outputs of the amplifier. This control affects the level of the loudspeaker output, the pre-amp output and the headphone output. It does not affect the Tape Out connections. It is advisable to turn the Volume control fully anti-clockwise before switching the amplifier on.

The Volume control is also used in navigating the 840A System Configure menus on the front panel display.

**Please refer to the 'Operating instructions' section of this manual for more information on some functions of these buttons.**

## REMOTE CONTROL

The 840A is supplied with an Azur Navigator remote control that operates both this amplifier and Cambridge Audio Azur CD players. Insert the supplied AAA batteries to activate.

The 840A/C remote control comes with an Amplifier Control button, that when pressed, puts the remote into **Amp mode**, allowing operation of the 840A. When pressed, the LED will light up for 7 seconds (to let you know you are in Amp mode), and will then flash when one of the circled Amp buttons is pressed. All other remote buttons are inactive when in Amp mode.

The functions relevant to the amplifier are as follows:

### Standby/On

Switches the amplifier between On and Standby mode.

### Numerical buttons 1-8

Press to change the input source to the amplifier. Button 8 toggles Tape Monitor on/off.

### Mode

Press to switch between Volume and Balance modes.

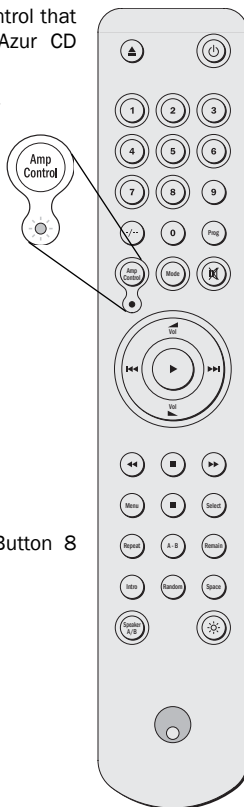

### Mute

Mutes the audio on the amplifier. The mute mode is indicated by MUTE appearing and the volume level being replaced by two flashing dashes in the display. Press again to cancel mute.

### Volume

Increase or decrease the volume of the amplifier output.

### Speaker A/B

Press to scroll through the speaker sets connected to the loudspeaker terminals on the back panel (speaker sets A, B or A and B).

### Bright

Adjust the backlight of the front panel display; bright, dim or off.

To exit Amp mode (and return to CD mode), press the *Amp Control* button again (the LED will light up for one second).

## CONNECTIONS

When designing our amplifiers we have tried to include features that allow you to connect your system in various ways. The inclusion of features such as Pre-Out and Speaker B connections mean that you can flexibly configure your system depending on your requirements. The following diagrams are designed to make connection easy.

### Basic connection

The diagram below shows the basic connection of your amplifier to a CD player and a pair of loudspeakers.

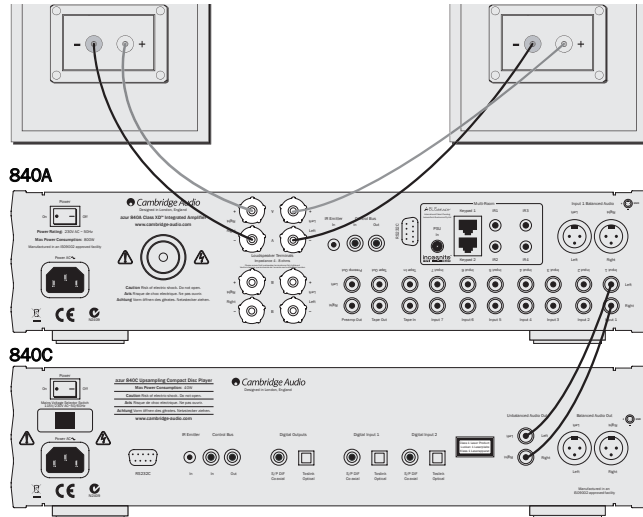

### Tape connection

The diagram below shows how to connect the amplifier to a tape recorder or other source with a record and monitor connection.

Please note that either of the tape loop outputs can be used (as they are both the same signal in parallel).

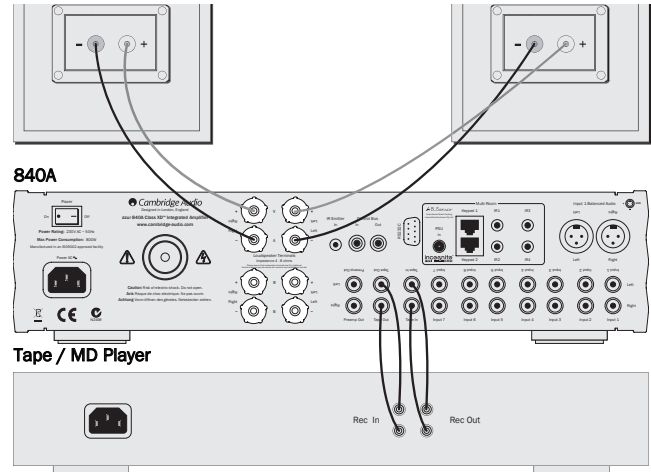

## CONNECTIONS (CONTINUED)

### Speaker B connections

The Speaker B connections on the back of the amplifier allow for a second set of speakers to be used (i.e. speakers located in another room). The Speaker A/B button on the front panel allows this second set of speakers to be switched on and off.

**Note:** When using two pairs of speakers, use speakers with a nominal impedance of between 6-8 ohms each minimum.

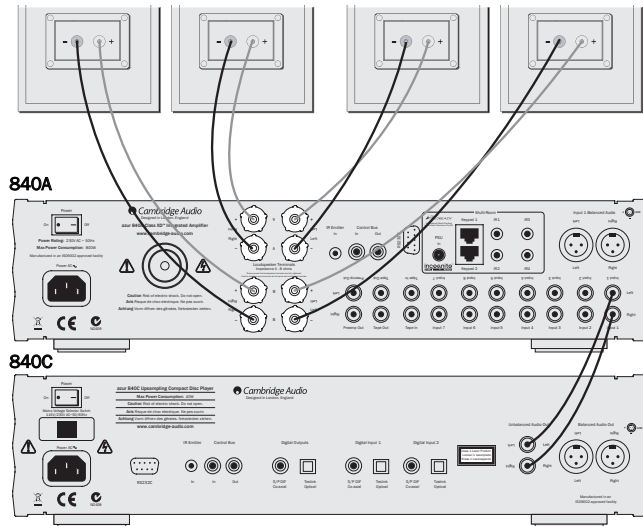

### Preamp Out connections

The Preamp Out sockets are for connecting to the input sockets of a power amplifier or active subwoofer. The diagram below shows how to connect the amplifier to an active subwoofer via the Line In inputs on the subwoofer.

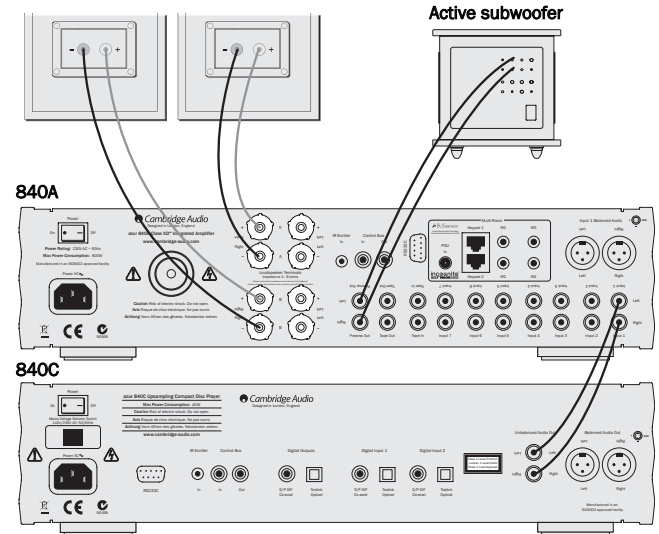

## Balanced audio connections

The diagram below shows how to connect the 840A to the Azur 840C Upsampling CD player using the Balanced Audio inputs via three-pin XLR connectors (Note: the 840A can also be connected to non-Cambridge Audio sources with balanced outputs).

Balanced connections in an audio system are designed to reject electrical noise, from power wiring etc, and also the effects of noise currents flowing through ground connections. The basic principle of

balanced interconnection is to get the signal you want by subtraction, using a three-wire connection. One signal wire (the hot or in-phase) carries the normal signal, while other (the cold or phase-inverted) carries an inverted version. The balanced input senses the difference between the two lines to give the wanted signal. Any noise voltages that appear identically on both lines (these are called common-mode signals) are cancelled by the subtraction. An additional advantage is that the connection effectively carries twice the signal level and so improves the signal-to-noise ratio.

The 840A and 840C are designed to work at their highest performance when a balanced interconnect is used; high quality stereo XLR to XLR interconnects should be used.

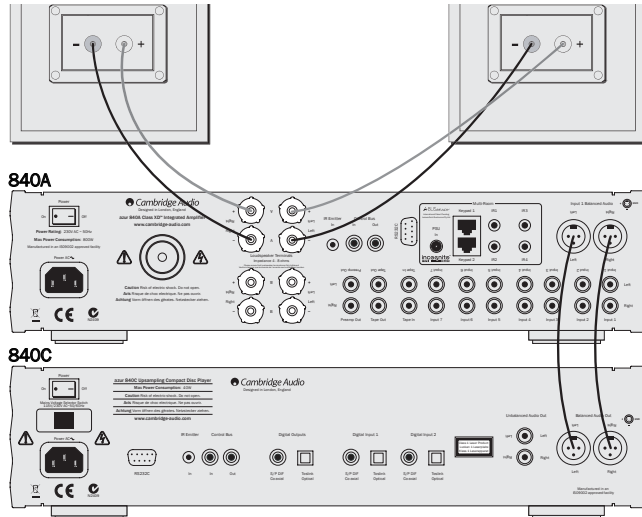

## OPERATING INSTRUCTIONS

The 840A has a custom-made display on the front of the unit showing the current status and allowing you to access the 840A System Configure menus. Here you can adjust the listening settings of the amplifier to personal preference. The menu system is easy to navigate and control, simply by using the input select buttons to turn a feature on (solid circle) or off (no circle) and the volume control knob to increase/decrease settings.

### Volume

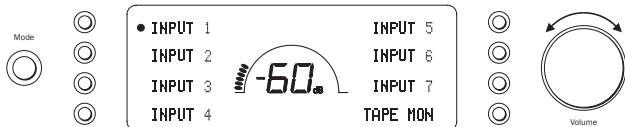

Adjust the volume control knob on the front panel (or using the remote control). The display will show the change in volume in decibels (dB). '0dB' indicates maximum volume while lower volume settings progress into the negative range. This can also be changed to volume units (0-72) in the System Configure menu.

### Speaker A/B

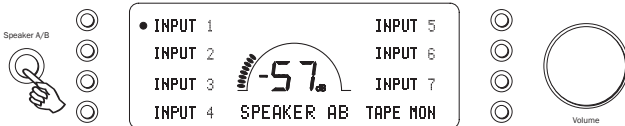

Press the *Speaker A/B* button to scroll through the speaker sets connected via the rear panel: speakers A, B or A and B.

### Balance

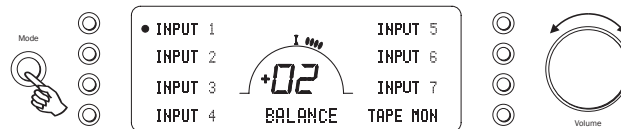

Press the *Mode* button to enter Balance mode. BALANCE will appear on the display and can be adjusted using the volume control. Press the *Mode* button again to return to Volume mode or wait 5 seconds for the 840A to automatically exit Balance mode.

### Bass and Treble

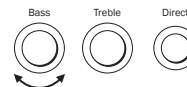

These controls allow subtle adjustments to the tonal balance of the sound. Press to release and rotate to adjust (press back in when desired settings found). In the central position these controls have no effect.

These controls only modify the sound through your loudspeakers and the Pre-Out sockets; they do not affect the signals sent through the Tape Out connections. With a well produced CD and a good system the tone controls are unnecessary and can be switched out by the Direct switch. This completely removes them from the signal path for maximum fidelity. If the musical recording is of poor quality or other factors are affecting the sound quality, it may be necessary to adjust the tone controls to compensate.

## AMPLIFIER SETUP

The 840A features many advanced settings that allow its use to be customised to user preference. The inputs can be named to reflect the actual source units you have, each input can be trimmed so that each sounds the same in terms of loudness when you switch between them and other options.

### Changing input names / source naming



Press and hold the relevant input select button for four seconds to change its name. For example, if Input 1 is a CD player, name it “CD” etc. Letters are selected by turning the volume control to scroll through the available characters. Press LEFT or RIGHT to select which character you wish to edit. Press EXT CHAR to access an extended character set. Press OK to confirm and exit the input name change menu.

### System Configure menu

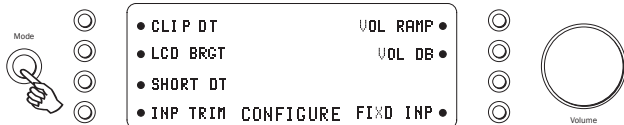

Press and hold the *Mode* button to access the System Configure menu. The menu options are Clip detector, LCD brightness, Speaker short detector, Input gain trim, Volume ramp, Volume display and Fixed input gain. To exit the System Configure menu and its sub-menus, press the *Mode* button again.

### Clip detector / Speaker short detector

Refer to the ‘CAP5’ section of this manual for more information on the Clip and Short detection features of the 840A, as both can be enabled (default) or disabled.

### LCD brightness

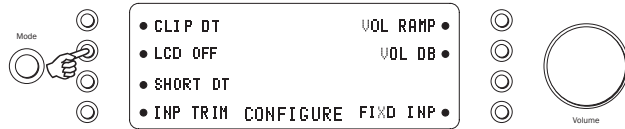

In the System Configure menu press the LCD input select button to scroll through bright/dim/off settings for the front panel display. Press the *Mode* button to exit.

### Volume ramp

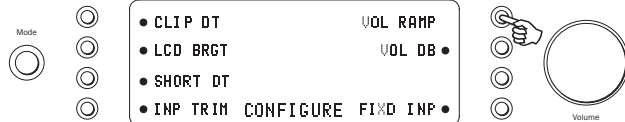

The 840A automatically ramps the volume down when going into Standby mode and up when coming out of Standby mode. To turn this feature off, press the VOL RAMP input select button in the System Configure menu and set to off. Press the *Mode* button to exit.

## AMPLIFIER SETUP (CONTINUED)

### Volume display

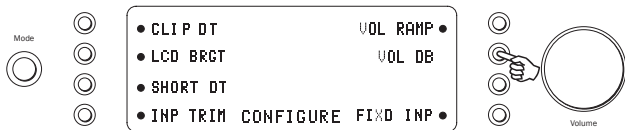

To change the volume display from decibels (-84 to 0dB) to arbitrary volume units (0 to 72 units) select VOL DB in the System Configure menu. Press the input select button to turn off the volume in decibels. Press the *Mode* button to exit.

### Input gain trim

The relative levels of the inputs can be adjusted by gain trim. This allows each to be adjusted so that each sounds the same in terms of average loudness when you switch between them. Pick the loudest sounding source and trim its level until it matches the average perceived level of the others. Repeat this process if other sources also stand out as louder than the average.



To set the input gain trim for each source, select INP TRIM in the System Configure menu. Select the input required and use the volume control to set the gain between 0 and -12 dB (the available range is restricted if the volume is set very low). Press the *Mode* button to exit.

### Fixed level inputs

Any input of the 840A is able to be set for fixed gain. Whenever this input is selected the gain will automatically go to this value and will not be adjustable by the volume control. This feature allows the 840A to be effectively used as a stereo power amplifier (for that selected input only). For example, as well as operating as a pure stereo amplifier, the 840A can provide the amplification for the front left and right channels of a surround sound setup with an AV receiver providing amplification for the other channels and controlling the overall system volume.

When listening in stereo use the 840A and connected stereo sources as normal for best possible sound quality. For surround sound, select the fixed level input you have chosen on the 840A and now use the AV receiver to control the volume, select connected surround sound sources etc. You may wish to re-name the fixed level input as “A/V mode” or similar on the 840A. Make connections as below, the left and right preamp outputs of the AV receiver connect to the fixed gain input chosen on the 840A. As the gain can be fixed to any value it is easy to match the level of the 840A to that of the other AV channels.

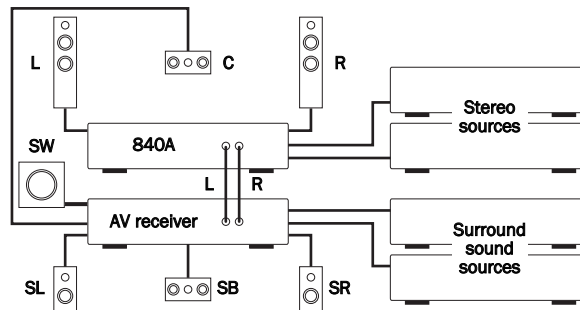



# 840A Class XD integrated amplifier

To set a fixed volume for a source, select FIXED INP in the System Configure menu:



Select the input required and set the fixed gain using the volume control (the OFF setting does not disable the input but leaves the input gain subject to the volume control which is the default setting). When a source has a fixed input, the balance is always set to neutral. Press the *Mode* button to exit.

## On/Off control menu

When going in/out of Standby mode the 840A can automatically turn on and off other connected Cambridge Audio Azur models that have control bus sockets. For this feature to work the units must be connected together (see diagram) by RCA/phono leads. The sockets are colour-coded orange on the rear panels of compatible Azur models. Loop out from the 840A Control Bus Out to the Control Bus In on another Azur model (e.g. 840C). Continue the chain to other Azur models if required.

Now while the 840A is on press and hold the *Standby/On* button until ON/OFF CTR appears on the display:

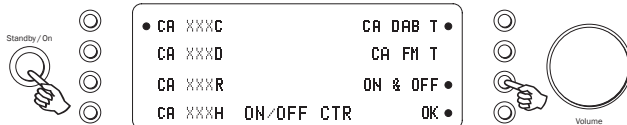

Select the connected Azur models by pressing the appropriate input select button. For example, CA XXXC for an Azur CD player (540C V2, 640C V2), CA XXXD for an Azur DVD player, CA DAB T for an Azur DAB tuner etc.

Press ON & OFF to scroll through the options of ON (turns all Azur units on only), OFF (turns all Azur units into Standby only) or ON & OFF (turns all Azur units on and into Standby mode). Press OK to confirm and exit.

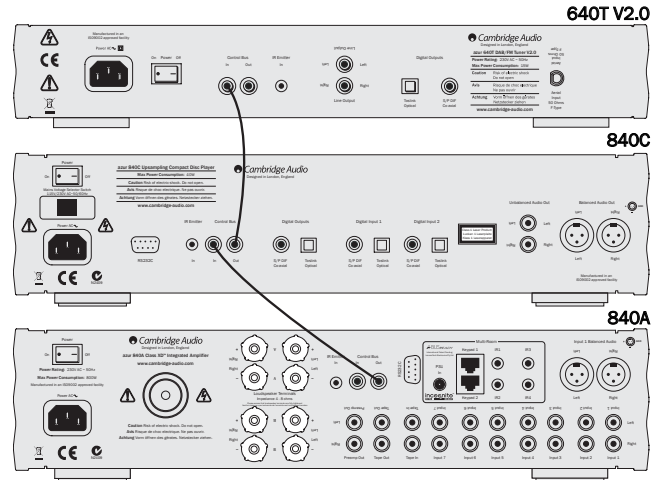

## MULTI-ROOM

The 840A features Incognito Ready™ / A-BUS™ Ready outputs, allowing multi-room capability. One or two amplified keypads can be plugged into the amplifier (using Cat5/5e cable and RJ45 plugs) to provide multi-room audio in one or two secondary rooms or zones. The keypads are powered by an external PSU (also required) through the Cat5/5e cables and no mains connection is required in the secondary rooms.

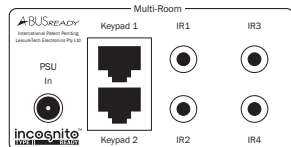

The 840A is Incognito Ready Type II, which means the keypads can operate independently of the amplifier in terms of volume/bass/treble etc, be independently turned on and off, and can also listen to a different source from that which is currently selected on the amplifier. However, both keypads can only listen to the same source.

A-BUS is a standard that allows compatibility between different manufacturers equipment, so A-BUS compatible keypads from other manufacturers can be used. If used with our own Incognito KP10 keypads, there are some extra features such as the ability to change source on the amplifier from the keypad.

To allow control of your source equipment from the remote rooms an IR emitter (IR10) is plugged into one of the IR outputs on the rear of the unit and then attached over the IR window of the source unit. Alternatively, on our own products that feature IR emitter Inputs, a mini-jack lead can be used. Commands received by the keypads can now be sent back to the source equipment via the amplifier.

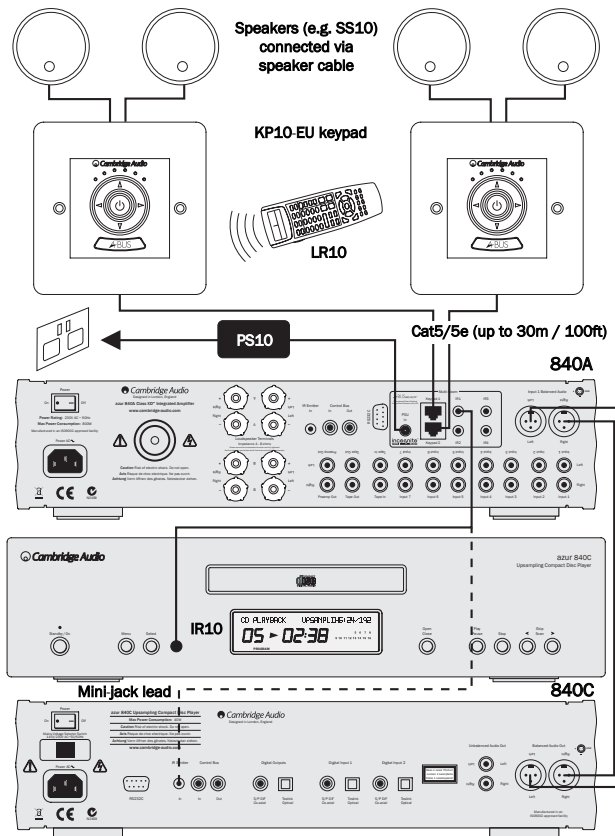

## CUSTOM INSTALLATION (C.I.) USE

It is then possible to control the source equipment from the remote rooms by using the source equipment's own remote controls or through a learning remote. The Incognito LR10 can fully control the keypads, "learn" the source's remote control codes (including those from other manufacturers) and change source input on the amplifier etc.

On the front panel display of the 840A the extra multi-room zones are indicated by a circle outline next to the input source (see Fig. 1). When listening to the same source, the circle outline and solid circle overlap (see Fig. 2).

**Fig. 1** - One or both keypads are listening to a different source (Input 2) to the amplifier (Input 1).

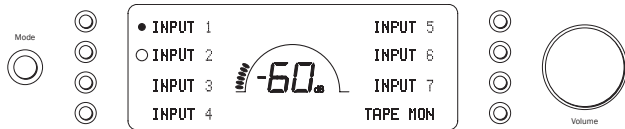

**Fig. 2** - One or both keypads are listening to the same source (Input 2) as the amplifier (Input 2).

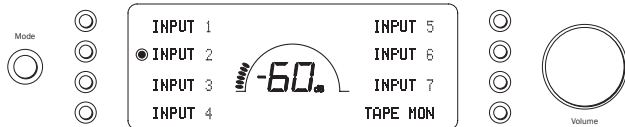

For further details on the Incognito multi-room system please contact your local Cambridge Audio dealer.

The 840A features a Control Bus input/output that allow un-modulated remote control commands (positive logic, TTL level) to be received electrically by the unit and looped to another unit if desired. These control commands are typically generated by custom installation (multi-room) systems or remote IR receiver systems. The Control Bus sockets are colour-coded orange.

An IR Emitter Input is also provided that allows modulated IR remote control commands to be received electrically by the unit. Commands on this input operate the unit only and are not looped out demodulated on the Control Bus Output. An RS232C port is also featured which allows the 840A to be controlled by C.I. systems.

In addition the units feature 'direct' IR/Control codes as well as toggle codes for some of their features to simplify programming custom installation systems. Special direct On/Off and Mute commands can be accessed on the supplied remote control for teaching into C.I. systems as follows:

1. Press and hold the *Standby/On* button. The remote first generates it's standby (toggle) command. Keep the button held down, after 12 seconds an amplifier "On" command will be generated. If the button is kept held down for a further 12 seconds, an amplifier player "Off" command is generated.
2. Press and hold the *Mute* button. The remote first generates it's mute (toggle) command. Keep the button held down, after 12 seconds a "Mute on" command will be generated. If the button is kept held down for a further 12 seconds, a "Mute off" command is generated.

A full code table and RS232C protocol for this product is available on the Cambridge Audio website at [www.cambridge-audio.com](http://www.cambridge-audio.com).

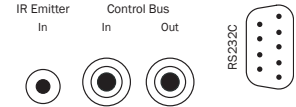

## CAP5 - FIVE WAY PROTECTION SYSTEM

Cambridge Audio has developed a proprietary protection system to ensure reliability and a long life to its amplifiers. This protection system comprises of five main protection methods:

### 1. DC detection

*Indication* - Unit has switched off during operation, display flashes “DC ERROR”.

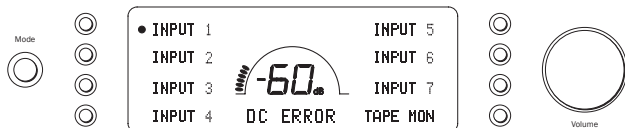

*Description* - CAP5 offers loudspeaker protection if the output of the amplifier goes to a high constant voltage (DC) because of some internal fault. This is a rare fault although detecting it could just save those expensive loudspeakers.

*Remedy* - Due to the necessary sensitivity of the DC protection circuit, hard clipping of the amplifier may cause DC protection to be triggered. If this fault occurs please switch the unit off, power up again and check operation with a reduced volume level. If the DC fault occurs again please contact your dealer for service.

### 2. Over temperature detection

*Indication* - Unit has switched off during operation, display flashes “OVER TEMP”.

*Description* - CAP5 includes temperature detection which constantly monitors the heat generated by the output transistors. If the monitored temperature reaches a high level (suitably within the limits of the output devices) the amplifier will automatically switch into a fault mode. The unit should ideally be left for 15 minutes in this state to cool down adequately.

**20** Azur Class XD integrated amplifier

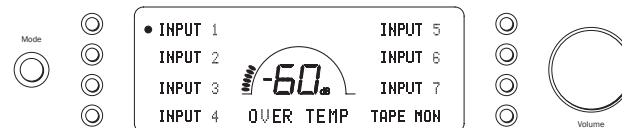

If the unit has not fully cooled down then the temperature may reach the limit soon after the amplifier is powered up. If the loudspeaker impedance is low the temperature of the amplifier may rise faster as the amplifier is working harder. If the amplifier is mounted in a cabinet or the ventilation slots are obstructed the over temperature detection may activate/reactivate after a short listening time.

*Remedy* - User related fault. The internal temperature of the output transistors has reached the over temperature limit. The unit is not damaged, although it should be left for 15 minutes to cool down before pressing the Standby button to resume normal operation.

### 3. Overvoltage/overcurrent detection

*Indication* - The display flashes “OVERLOAD”.

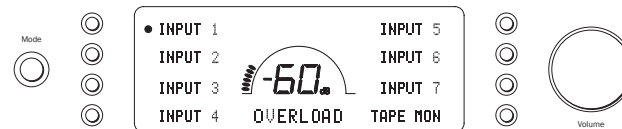

*Description* - CAP5 offers V/I protection by constantly monitoring the output transistors to keep them working inside their Safe Operating Area (SOA). The SOA is a set of limits given by the output transistor manufacturer to ensure reliability. The 840A deals gracefully with brief periods of overload by controlling the drive to the output transistors. If the overload is sustained for a period, the output relays disconnect the amplifier from the loudspeakers and the display shows a flashing

"OVERLOAD" indication. The amplifier will stay in this state until the Standby/ON switch is pressed to reset it.

**Remedy** - The resistance on the loudspeaker terminals is too low. Check to see if there is a short circuit between the loudspeaker terminals.

**Note:** If the indication remains the same and multiple loudspeakers are being used on each loudspeaker output then please remove a pair and retry. If too many loudspeakers are connected to any amplifier causing the load resistance to drop too low the amplifier will be overloaded. CAP5 will detect this situation. If the indication remains the same with only one set of loudspeakers connected, there may be a fault with one or both of the loudspeakers.

## 4. Short circuit detection

**Indication** - Unit has not come out of Standby, display flashes "SPKR SHORT".

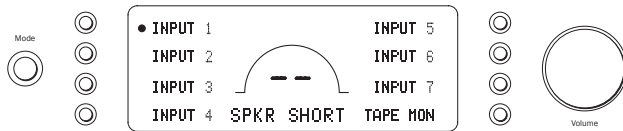

**Description** - During power up from Standby CAP5 performs a check on the loudspeaker terminals to see if a short across the terminals has been accidentally introduced (display flashes "SPKR CHECK"). If the resistance measured across the loudspeaker terminals is too low the unit will stay in Standby mode until the fault has been removed and Power up is re-attempted (display flashes "SPKR SHORT").

**Remedy** - User related fault. There may be a short circuit between the loudspeaker terminals. Check all loudspeaker connections before attempting to switch the unit out of Standby (display will flash "SPKR CHECK" then "SPKR OK" when short circuit fixed).

It is possible to disable the short circuit detection feature by pressing the SHORT DT button to off when in the 840A System Configure menu. This would only be required if the loudspeakers have very low DC resistance.

## 5. Intelligent clipping detection

**Indication** - Volume is reduced automatically, "CLIPPING" appears on the front panel display.

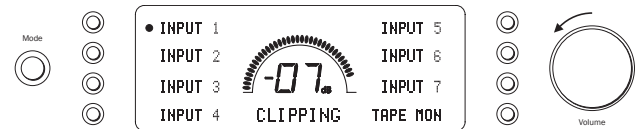

**Description** - CAP5 has the ability to detect when the amplifier starts to clip or overdrive at its output, which can damage loudspeakers, and degrade the sound. Clipping distortion is caused at high volume levels when the output signal attempts to go outside the maximum voltage that the amplifier can provide, causing the tops of the signal to flatten off. When CAP5 detects clipping the volume will be automatically reduced down until CAP5 detects an undistorted output.

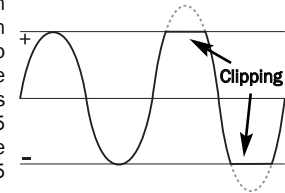

It is possible to disable the clipping detection feature by pressing the CLIP DT button to off when in the 840A System Configure menu.

**Note:** Disabling the clipping detection is not advised as this feature has been added deliberately to protect the amplifier and loudspeakers.

## TROUBLESHOOTING

### **There is no power**

Ensure the AC power cord is connected securely.

Ensure the plug is fully inserted into the wall socket and is switched on.

Check fuse in the mains plug or adaptor.

### **There is no sound**

Make sure the unit is not in Standby mode.

Check that source component is properly connected.

Check that 'TAPE MON' is not switched on (unless tape input is required).

Check that your speakers are properly connected.

If using Speaker B terminals check they are switched on.

Make sure unit is not in mute mode.

### **There is no sound on one channel**

Ensure that balance control is in the correct position.

Check speaker connections.

Check interconnects.

### **There is a loud buzz or hum**

Check turntable or tone arm for ground and connection lead fault.

Ensure no interconnects are loose or defective.

Ensure that your tape deck/turntable is not too close to the amplifier.

### **Unable to make or play tape recordings**

Check that TAPE MON and TAPE OUT have been connected correctly.

### **There is weak bass or diffused stereo imaging**

Ensure that speakers are not wired out of phase.

### **Message on display flashing**

See section on CAP5 protection system.

## TECHNICAL SPECIFICATIONS

	<b>840A</b>
<b>Power Output</b>	120W RMS into 8 Ohms 200W RMS into 4 Ohms
<b>THD (unweighted)</b>	< 0.0015% 1 kHz at 80% of rated power  < 0.015% 20 Hz - 20 kHz at 80% of rated power
<b>Frequency Response</b>	10 Hz - 50 kHz +/- 1 dB
<b>S/N ratio (ref 1W/8 Ohm)</b>	> 83 dB
<b>Input impedances</b>	Input 1 (balanced) 10 kOhm Inputs 2-7 68 kOhm Tape Input 68 kOhm
<b>Power Amp damping factor</b>	> 110 at 1 kHz
<b>Max power consumption</b>	800W
<b>Minimum power consumption</b>	Active (no signal) 70W Standby 7W
<b>Bass &amp; Treble controls</b>	Shelving type Max bass boost/cut +/- 10 dB at 10 Hz Max treble boost/cut +/- 7.5 dB at 20 kHz
<b>Dimensions (H x W x D)</b>	115 x 430 x 385mm (4.5 x 16.9 x 15.2")
<b>Weight</b>	15.0kg (33Lbs)

This guide is designed to make installing and using this product as easy as possible. Information in this document has been carefully checked for accuracy at the time of printing; however, Cambridge Audio's policy is one of continuous improvement, therefore design and specifications are subject to change without prior notice. If you notice any errors please feel free to email us at: [support@cambridgeaudio.com](mailto:support@cambridgeaudio.com)

This document contains proprietary information protected by copyright. All rights are reserved. No part of this manual may be reproduced by any mechanical, electronic or other means, in any form, without prior written permission of the manufacturer. All trademarks and registered trademarks are the property of their respective owners.

Incognito and Incognito Ready are trademarks of Cambridge Audio Ltd. All rights reserved. Class XD Technology International Patent Pending Cambridge Audio Ltd.

© Copyright Cambridge Audio Ltd 2006

A-BUS and A-BUS Ready are registered trademarks of LeisureTech Electronics Pty Ltd Australia.

## LIMITED WARRANTY

Cambridge Audio warrants this product to be free from defects in materials and workmanship (subject to the terms set forth below). Cambridge Audio will repair or replace (at Cambridge Audio's option) this product or any defective parts in this product. Warranty periods may vary from country to country. If in doubt consult your dealer and ensure that you retain proof of purchase.

To obtain warranty service, please contact the Cambridge Audio authorised dealer from which you purchased this product. If your dealer is not equipped to perform the repair of your Cambridge Audio product, it can be returned by your dealer to Cambridge Audio or an authorised Cambridge Audio service agent. You will need to ship this product in either its original packaging or packaging affording an equal degree of protection.

Proof of purchase in the form of a bill of sale or receipted invoice, which is evidence that this product is within the warranty period, must be presented to obtain warranty service.

This Warranty is invalid if (a) the factory-applied serial number has been altered or removed from this product or (b) this product was not purchased from a Cambridge Audio authorised dealer. You may call Cambridge Audio or your local country Cambridge Audio distributor to confirm that you have an unaltered serial number and/or you purchased from a Cambridge Audio authorised dealer.

This Warranty does not cover cosmetic damage or damage due to acts of God, accident, misuse, abuse, negligence, commercial use, or modification of, or to any part of, the product. This Warranty does not cover damage due to improper operation, maintenance or installation, or attempted repair by anyone other than Cambridge Audio or a

Cambridge Audio dealer, or authorised service agent which is authorised to do Cambridge Audio warranty work. Any unauthorised repairs will void this Warranty. This Warranty does not cover products sold AS IS or WITH ALL FAULTS.

REPAIRS OR REPLACEMENTS AS PROVIDED UNDER THIS WARRANTY ARE THE EXCLUSIVE REMEDY OF THE CONSUMER. CAMBRIDGE AUDIO SHALL NOT BE LIABLE FOR ANY INCIDENTAL OR CONSEQUENTIAL DAMAGES FOR BREACH OF ANY EXPRESS OR IMPLIED WARRANTY IN THIS PRODUCT. EXCEPT TO THE EXTENT PROHIBITED BY LAW, THIS WARRANTY IS EXCLUSIVE AND IN LIEU OF ALL OTHER EXPRESS AND IMPLIED WARRANTIES WHATSOEVER INCLUDING, BUT NOT LIMITED TO, THE WARRANTY OF MERCHANTABILITY AND FITNESS FOR A PRACTICAL PURPOSE.

Some countries and US states do not allow the exclusion or limitation of incidental or consequential damages or implied warranties so the above exclusions may not apply to you. This Warranty gives you specific legal rights, and you may have other statutory rights, which vary from state to state or country to country.





 *Cambridge Audio*

**azur 840A**



[www.cambridge-audio.com](http://www.cambridge-audio.com)

Part No. AP18646/2