

azur

851E

 **Cambridge Audio**
Your music + our passion

Contents

Important safety instructions	3
Limited warranty.....	4
Rear panel connections.....	5
Front panel controls.....	6
Remote control.....	7
Source connections	8
Power syncing (On/Standby control).....	8
Output connections - Balanced.....	9
Output connections - Unbalanced	9
Mono Bridged connections.....	10
Operating instructions	11
Pre-amplifier setup.....	11
CAP5: Five-way protection system.....	14
Custom installation (C.I.) use	15
Technical specifications.....	15
Troubleshooting.....	15

Make sure you register your purchase.

Visit: www.cambridge-audio.com/sts

By registering, you'll be the first to know about:

- **Future product releases**
- **Software upgrades**
- **News, events and exclusive offers plus competitions!**

This guide is designed to make installing and using this product as easy as possible. Information in this document has been carefully checked for accuracy at the time of printing; however, Cambridge Audio's policy is one of continuous improvement, therefore design and specifications are subject to change without prior notice.

This document contains proprietary information protected by copyright. All rights are reserved. No part of this manual may be reproduced by any mechanical, electronic or other means, in any form, without prior written permission of the manufacturer. All trademarks and registered trademarks are the property of their respective owners.

© Copyright Cambridge Audio Ltd 2013.

Cambridge Audio and the Cambridge Audio logo are trademarks of Cambridge Audio.

Other brands mentioned are trademarks of their respective owners and are used for reference purposes only.

Important safety instructions

For your own safety please read the following important safety instructions carefully before attempting to connect this unit to the mains power supply. They will also enable you to get the best performance from and prolong the life of the unit:

1. Read these instructions.
2. Keep these instructions.
3. Heed all warnings.
4. Follow all instructions.
5. Do not use this apparatus near water.
6. Clean only with a dry cloth.
7. Do not block any ventilation openings. Install in accordance with the manufacturer's instructions.
8. Do not install near any heat sources such as radiators, heat registers, stoves, or other apparatus (including other amplifiers) that produce heat.
9. Do not defeat the safety purpose of the polarized or grounding-type plug. A polarized plug has two blades with one wider than the other. A grounding-type plug has two blades and a third grounding prong. The wide blade or the third prong are provided for your safety. If the provided plug does not fit into your outlet, consult an electrician for replacement of the obsolete outlet.
10. Protect the power cord from being walked on or pinched, particularly at plugs, convenience receptacles and the point where they exit from the apparatus.
11. Only use attachments/accessories specified by the manufacturer.
12. Use with only the cart, stand, tripod, bracket, or table specified by the manufacturer, or sold with the apparatus. When a cart is used, use caution when moving the cart/ apparatus combination to avoid injury from tip-over. 
13. Unplug this apparatus during lightning storms or when unused for long periods of time.
14. Refer all servicing to qualified service personnel. Servicing is required when the apparatus has been damaged in any way, such as the power-supply cord or plug having been damaged, liquid has been spilled or objects have fallen into the apparatus, the apparatus has been exposed to rain or moisture, does not operate normally, or has been dropped.

WARNING

- To reduce the risk of fire or electric shock, do not expose this unit to rain or moisture.
- Batteries (battery pack or batteries installed) shall not be exposed to excessive heat such as sunshine, fire or the like.

The unit is of Class 1 construction and must be connected to a mains socket outlet with a protective earthing connection.

The unit must be installed in a manner that makes disconnection of the mains plug from the mains socket outlet (or appliance connector from the rear of the unit) possible. Where the mains plug is used as the disconnect device, the disconnect device shall remain readily operable. Only use the mains cord supplied with this unit.

Please ensure there is ample ventilation. We recommend that you do not place the unit in an enclosed space; if you wish to place the unit on a shelf, use the top shelf to allow maximum ventilation. Do not put any objects on top of this unit. Do not situate it on a rug or other soft surface and do not obstruct any air inlets or outlet grilles. Do not cover the ventilation grilles with items such as newspapers, tablecloths, curtains, etc.

This unit must not be used near water or exposed to dripping or splashing water or other liquids. No objects filled with liquid, such as vases, shall be placed on the unit.



The lightning flash with the arrowhead symbol within an equilateral triangle is intended to alert the user to the presence of un-insulated 'dangerous voltage' within the product's enclosure that may be of sufficient magnitude to constitute a risk of electric shock to persons.

The exclamation point within an equilateral triangle is intended to alert the user to the presence of important operating and maintenance instructions in the service literature relevant to this appliance.

WEEE symbol



The crossed-out wheeled bin is the European Union symbol for indicating separate collection for electrical and electronic equipment. This product contains electrical and electronic equipment which should be reused, recycled or recovered and should not be disposed of with unsorted regular waste.

Please return the unit or contact the authorised dealer from whom you purchased this product for more information.

CE mark



This product complies with European Low Voltage (2006/95/EC), Electromagnetic Compatibility (2004/108/EC) and Environmentally-friendly design of Energy-related Products (2009/125/EC) Directives when used and installed according to this instruction manual. For continued compliance only Cambridge Audio accessories should be used with this product and servicing must be referred to qualified service personnel.

C-Tick mark



This product meets the Australian Communications Authority's Radio communications and EMC requirements.

Gost-R Mark



This product meets Russian electronic safety approvals.

FCC regulations

NOTE: THE MANUFACTURER IS NOT RESPONSIBLE FOR ANY RADIO OR TV INTERFERENCE CAUSED BY UNAUTHORIZED MODIFICATIONS TO THIS EQUIPMENT. SUCH MODIFICATIONS COULD VOID THE USER AUTHORITY TO OPERATE THE EQUIPMENT.

FC This equipment has been tested and found to comply with the limits for a Class B digital device, pursuant to Part 15 of the FCC Rules. These limits are designed to provide reasonable protection against harmful interference in a residential installation. This equipment generates, uses and can radiate radio frequency energy and, if not installed and used in accordance with the instructions, may cause harmful interference to radio communications. However, there is no guarantee that interference will not occur in a particular installation.

If this equipment does cause harmful interference to radio or television reception, which can be determined by turning the equipment off and on, the user is encouraged to try to correct the interference by one or more of the following measures:

- Re-orient or relocate the receiving antenna.
- Increase the separation between the equipment and receiver.
- Connect the equipment into an outlet on a circuit different from that to which the receiver is connected.
- Consult the dealer or an experienced radio/TV technician for help.

Ventilation

IMPORTANT – The unit will become hot when in use. Do not stack multiple units on top of each other. Do not place in an enclosed area such as a bookcase or in a cabinet without sufficient ventilation.

Ensure that small objects do not fall through any ventilation grille. If this happens, switch off immediately, disconnect from the mains supply and contact your dealer for advice.

Positioning

Choose the installation location carefully. Avoid placing it in direct sunlight or close to a source of heat. No naked flame sources, such as lighted candles, should be placed on the unit. Also avoid locations subject to vibration and excessive dust, cold or moisture. The unit can be used in a moderate climate.

This unit must be installed on a sturdy, level surface. Do not place in a sealed area such as a bookcase or in a cabinet. Do not place the unit on an unstable surface or shelf. The unit may fall, causing serious injury to a child or adult as well as serious damage to the product. Do not place other equipment on top of the unit.

Due to stray magnetic fields, turntables or CRT TVs should not be located nearby due to possible interference.

Electronic audio components have a running in period of around a week (if used several hours per day). This will allow the new components to settle down and the sonic properties will improve over this time.

Power sources

The unit should be operated only from the type of power source indicated on the marking label. If you are not sure of the type of power-supply to your home, consult your product dealer or local power company.

This unit can be left in Standby mode when not in use and will draw <0.5W in this state. To turn the unit off, switch off at the rear panel. If you do not intend to use this unit for a long period of time, unplug it from the mains socket.

Overloading

Do not overload wall outlets or extension cords as this can result in a risk of fire or electric shock. Overloaded AC outlets, extension cords, frayed power cords, damaged or cracked wire insulation and broken plugs are dangerous. They may result in a shock or fire hazard.

Be sure to insert each power cord securely. To prevent hum and noise, do not bundle the interconnect leads with the power cord or speaker leads.

Cleaning

To clean the unit, wipe its case with a dry, lint-free cloth. Do not use any cleaning fluids containing alcohol, ammonia or abrasives. Do not spray an aerosol at or near the unit.

Battery disposal

Batteries may contain substances harmful to the environment. Please dispose of any discharged batteries with due consideration and in accordance with local environmental/electronic recycling guidelines.

Servicing

These units are not user serviceable. Never attempt to repair, disassemble or reconstruct the unit if there seems to be a problem. A serious electric shock could result if this precautionary measure is ignored. In the event of a problem or failure, please contact your dealer.

Limited warranty

Cambridge Audio warrants this product to be free from defects in materials and workmanship (subject to the terms set forth below). Cambridge Audio will repair or replace (at Cambridge Audio's option) this product or any defective parts in this product. Warranty periods may vary from country to country. If in doubt consult your dealer and ensure that you retain proof of purchase.

To obtain warranty service, please contact the Cambridge Audio authorised dealer from which you purchased this product. If your dealer is not equipped to perform the repair of your Cambridge Audio product, it can be returned by your dealer to Cambridge Audio or an authorised Cambridge Audio service agent. You will need to ship this product in either its original packaging or packaging affording an equal degree of protection.

Proof of purchase in the form of a bill of sale or receipted invoice, which is evidence that this product is within the warranty period, must be presented to obtain warranty service.

This Warranty is invalid if (a) the factory-applied serial number has been altered or removed from this product or (b) this product was not purchased from a Cambridge Audio authorised dealer. You may call Cambridge Audio or your local country Cambridge Audio distributor to confirm that you have an unaltered serial number and/or you made a purchase from a Cambridge Audio authorised dealer.

This Warranty does not cover cosmetic damage or damage due to acts of God, accident, misuse, abuse, negligence, commercial use, or modification of, or to any part of, the product. This Warranty does not cover damage due to improper operation, maintenance or installation, or attempted repair by anyone other than Cambridge Audio or a Cambridge Audio dealer, or authorised service agent which is authorised to do Cambridge Audio warranty work. Any unauthorised repairs will void this Warranty. This Warranty does not cover products sold AS IS or WITH ALL FAULTS.

REPAIRS OR REPLACEMENTS AS PROVIDED UNDER THIS WARRANTY ARE THE EXCLUSIVE REMEDY OF THE CONSUMER. CAMBRIDGE AUDIO SHALL NOT BE LIABLE FOR ANY INCIDENTAL OR CONSEQUENTIAL DAMAGES FOR BREACH OF ANY EXPRESS OR IMPLIED WARRANTY IN THIS PRODUCT. EXCEPT TO THE EXTENT PROHIBITED BY LAW, THIS WARRANTY IS EXCLUSIVE AND IN LIEU OF ALL OTHER EXPRESS AND IMPLIED WARRANTIES WHATSOEVER INCLUDING, BUT NOT LIMITED TO, THE WARRANTY OF MERCHANTABILITY AND FITNESS FOR A PRACTICAL PURPOSE.

Some countries and US states do not allow the exclusion or limitation of incidental or consequential damages or implied warranties so the above exclusions may not apply to you. This Warranty gives you specific legal rights, and you may have other statutory rights, which vary from state to state or country to country.

For any service, in or out of warranty, please contact your dealer.

Plug Fitting Instructions (UK only)

The cord supplied with this appliance is factory-fitted with a UK mains plug fitted with a 3-amp fuse inside. If it is necessary to change the fuse, it is important that a 3-amp fuse is used. If the plug needs to be changed because it is not suitable for your socket, or becomes damaged, it should be cut off and an appropriate plug fitted following the wiring instructions below. The plug must then be disposed of safely, as insertion into a mains socket is likely to cause an electrical hazard. Should it be necessary to fit a 3-pin BS mains plug to the power cord, the wires should be fitted as shown in this diagram. The colours of the wires in the mains lead of this appliance may not correspond with the coloured markings identifying the terminals in your plug. Connect them as follows:

The wire which is coloured BLUE must be connected to the terminal which is marked with the letter 'N' or coloured BLACK.

The wire which is coloured BROWN must be connected to the terminal which is marked with the letter 'L' or coloured RED.

The wire which is coloured GREEN/YELLOW must be connected to the terminal which is marked with the letter 'E' or coloured GREEN.

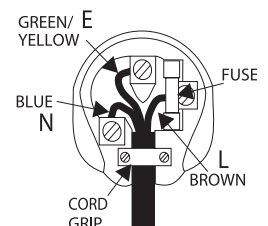

If a standard 13-amp (BS 1363) plug is used, a 3-amp fuse must be fitted or, if any other type of plug is used, a 3-amp fuse must be fitted, either in the plug or adaptor, or on the distribution board.

Rear panel connections

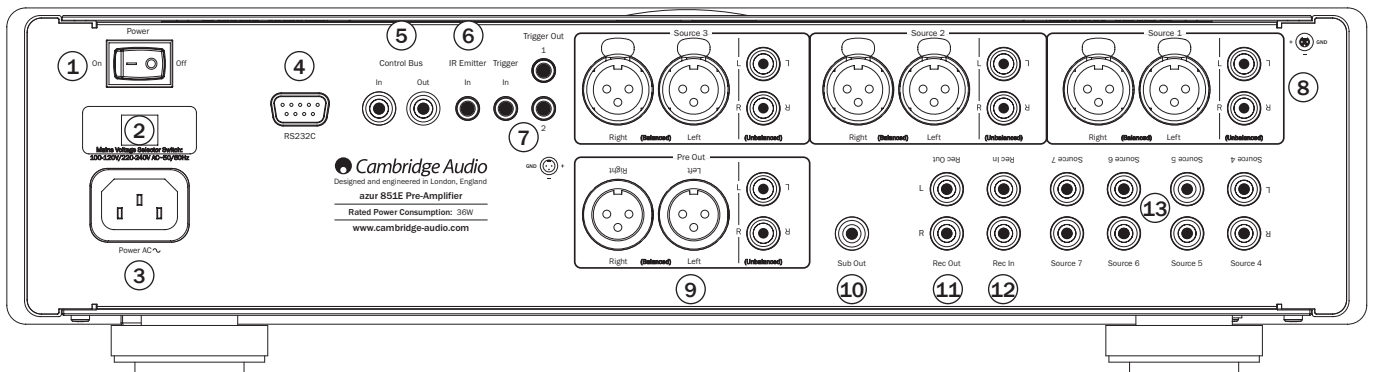

① Power On/Off

Switches the unit on and off.

This product has APD (Auto Power Down) enabled as default. After inactivity of 30 minutes, the product will automatically switch to Standby. See later section for further details.

② Mains Voltage Selector Switch

Switches the 851E mains voltage between 100-120V and 220-240V.

Note: Intended for use by a professional installer or Cambridge Audio retailer only.

③ AC power socket

Once you have completed all connections to the unit, plug the AC power cable into an appropriate mains socket then switch on. Your unit is now ready for use.

④ RS232C

The RS232C port allows external serial control of the 851E, for use in a custom installation. A full command set is available on the Cambridge Audio website at www.cambridge-audio.com. This port can also be used by Cambridge Audio service personnel for software updates.

⑤ Control Bus

In – Allows un-modulated commands from multi-room systems or other components to be received by the unit.

Out – Loop out for Control Bus commands to another unit.

Also allows the 851E to turn on/off some Cambridge Audio units, including the matching 851W power amplifier. Refer to the 'Power syncing' section of this manual for more information.

⑥ IR (Infra-Red) Emitter In

Allows modulated IR commands from multi-room systems or IR repeater systems to be received by the unit. Commands received here are not looped out of the Control Bus. Refer to the 'Custom installation' section of this manual for more information.

⑦ Trigger In, Trigger Out 1 and 2

For custom install use, the 851E can be turned on and off (i.e. brought in and out of Standby mode) by the presence of 5-12V DC at the Trigger input. A trigger input or by turning the 851E on from the remote/front panel will also produce an internally generated 12V DC trigger output at the Trigger Out 1 and 2 connection. This can be used to turn on/Standby a connected 851W power amplifier if desired. Refer to the 'Power syncing' section of this manual for more information.

⑧ Source 1-3

Source 1-3 feature either unbalanced (phono/RCA) or balanced (XLR) connections. Either type may be used but not both at the same time. The balanced connection is the higher quality option and can reject noise and interference in the cable when used with other equipment that supports this function. An XLR connector is wired Pin 1 - Ground; Pin 2 - Hot (in-phase); Pin 3 - Cold (phase-inverted).

⑨ Pre Out

For connection to the balanced/unbalanced inputs of a power amplifier.

⑩ Sub Out

Connect to the input on an active subwoofer if required.

⑪ Rec Out

Connect to the input sockets of your recording device.

⑫ Rec In (Source 8)

Connect to the output sockets of a Tape/MD player or other devices that support recording.

⑬ Source 4-7

These inputs are suitable for any 'line level' source equipment such as CD players, DAB or FM/AM tuners etc.

Note: These inputs are for analogue audio signals only. They should not be connected to the digital output of a CD player or any other digital device.

Front panel controls

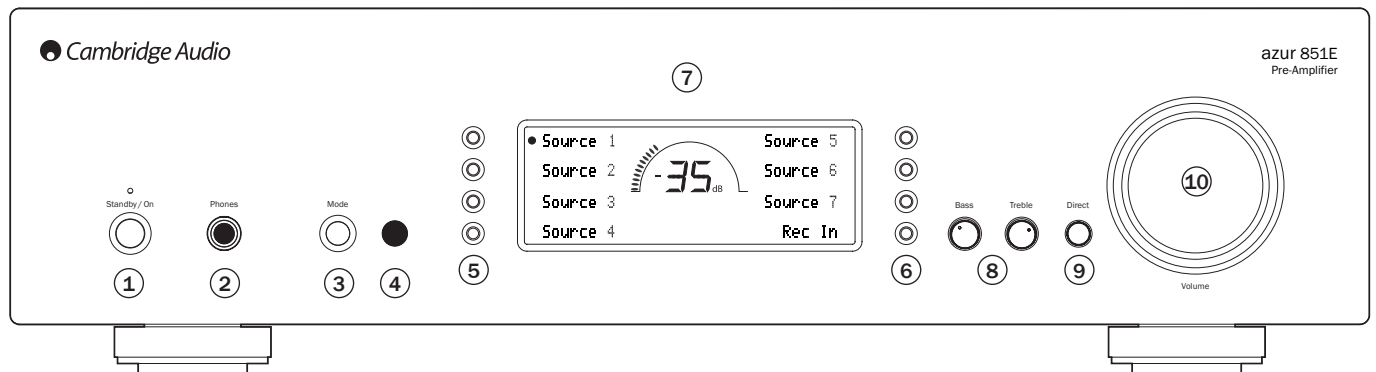

① Standby/On

Switches the unit between Standby mode (indicated by dim power LED) and On (indicated by bright power LED). Standby is a low power mode where the power consumption is less than 0.5 Watts. The unit can be left in Standby mode when not in use. If the unit is not going to be used for a long period of time it should be switched off via the Power On/Off switch on the rear panel.

Note: As default the 851E ramps the volume up or down when switched on and when going into Standby mode. This feature can be turned off if desired; please refer to the 'Pre-amplifier setup' section of this manual for more information.

② Phones

Allows for the connection of stereo headphones with a ¼" Jack plug. Headphones with an impedance of between 32 and 600 ohms are recommended. When the headphones are connected, the loudspeaker relays are released switching off the output to the loudspeakers.

IMPORTANT! Do not use headphones that exceed a 3 meter cable.

③ Mode

Press to switch between Volume and Balance modes. Press and hold to enter the 851E System Configure menu.

④ Infrared sensor

Receives IR commands from the supplied Azur remote control. A clear unobstructed line of sight between the remote control and the sensor is required.

⑤ & ⑥ Source select buttons

Push the appropriate input selection button to select the source component that you wish to listen to (highlighted by a solid circle on the display). The signal selected is also fed to the Rec Out sockets so that it may be recorded. The input should not be changed whilst recording (but the recorded signal can be checked using the Rec input).

Note:

- Repeatedly pressing the Source 1, 2 or 3 buttons will toggle these inputs between 'Balanced' and 'Unbalanced' source input.
- The solid circle will flash if there are no input signals detected.

⑦ Display

LCD used to control the 851E. Please refer to the 'Operating instructions' and 'Pre-amplifier setup' section of this manual for more information.

⑧ Bass and Treble

Press to release and rotate to allow subtle adjustments to the tonal balance of the sound.

⑨ Direct

This control gives the audio signal a more direct path by bypassing the tone control circuits for the purest possible sound quality.

The Bass/Treble icon () appears in the display when the bass and treble circuit is active (in circuit) and is not present when they are bypassed.

Note: Direct can be set on or off individually for each input. This setting is recalled each time a source is selected.

⑩ Volume

Use to increase/decrease the level of the sound from the outputs of the pre-amplifier. This control affects the level of the loudspeaker output, the pre-amp output and the headphone output. It does not affect the Rec Out connection.

The Volume control is also used in navigating the 851E System Configure menus on the front panel display.

Please refer to the 'Operating instructions' section of this manual for more information on some functions of these buttons.

Remote control

The 851E is supplied with a CA System remote control that operates both this amplifier and Cambridge Audio 851 series and Stream Magic products. Insert the supplied AAA batteries to activate.

The functions relevant to the amplifier are as follows:

1 Standby/On

Switches the amplifier between On and Standby mode.

2 Brightness

Adjust the backlight of the front panel display; bright, dim or off.

3 Mute

Mutes the audio on the pre-amplifier. The mute mode is indicated by Mute appearing and the volume level being replaced by two flashing dashes in the display. Press again to cancel mute.

4 Volume

Increase or decrease the volume of the amplifier output.

5 Illuminate button

Press to illuminate the buttons on the remote.

6 S1-S8 Sources

Used to select the source inputs.

7 Source Direct

Press to give the audio signal a more direct path to the power amplifier stage of your amplifier, bypassing the bass and treble control circuits for the purest possible sound quality.

8 Trigger 1 and Trigger 2

Pressing either button to toggle on/standby a 851W power amplifier that is connected through the rear Trigger Out 1 or 2.

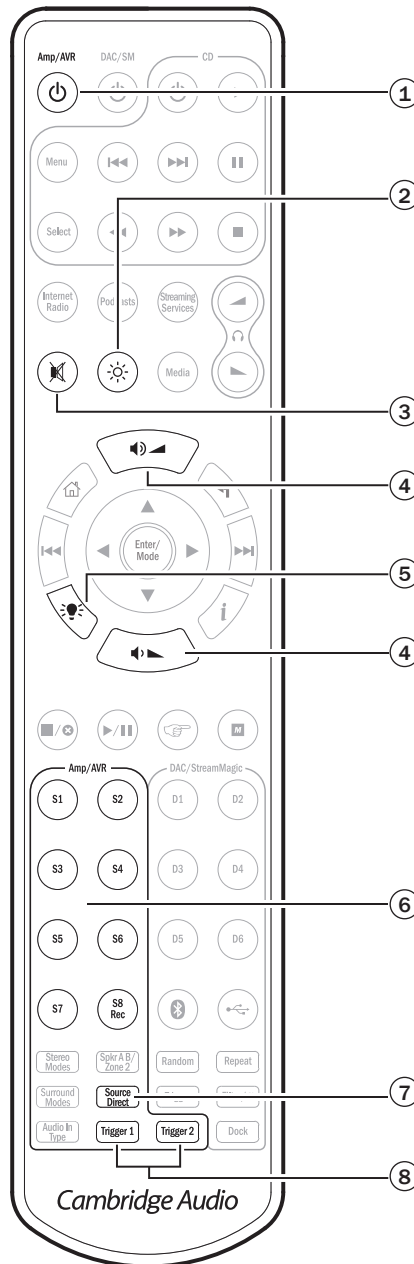

Source connections

Source 1, 2 and 3 on the 851E feature either unbalanced (phono/RCA) or balanced (XLR) connections. The 851E is designed to work at its highest performance when a balanced interconnect is used.

The diagrams below show the 851E pre-amplifier connected to an Azur 851C CD player in unbalanced (Figure 1) and balanced (Figure 2) configurations. The 851E can also be connected to non Cambridge Audio sources with balanced outputs.

Balanced connections in an audio system are designed to reject electrical noise, from power wiring etc, and also the effects of noise currents flowing through ground connections. The basic principle of balanced interconnection is to get the signal you want by subtraction, using a three-wire connection. One signal wire (the hot or in-phase) carries the normal signal, while other (the cold or phase-inverted) carries an inverted version. The balanced input senses the difference between the two lines to give the wanted signal. Any noise voltages that appear identically on both lines (these are called common-mode signals) are cancelled by the subtraction.

Figure 1: Unbalanced input

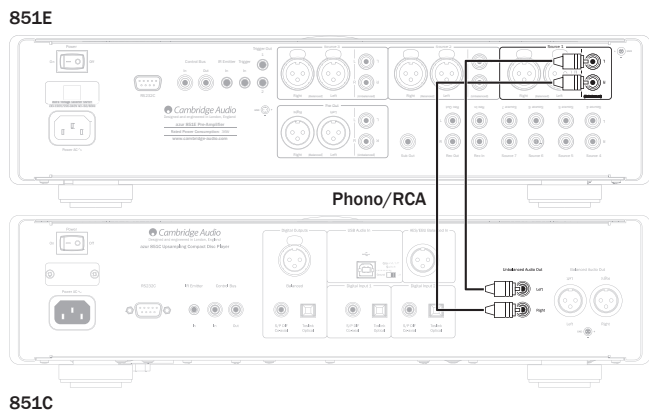
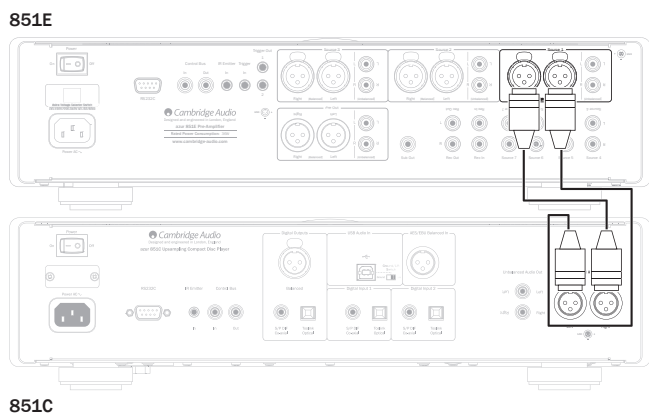

Figure 2: Balanced input



Power syncing (On/Standby control)

When going in/out of Standby mode the Azur 851E pre-amplifier can (if desired) automatically control the 851W when connected via the Control Bus sockets (the Control Bus sockets are colour-coded orange on the rear panels of compatible Azur models). For this feature to work the units must be connected together by RCA/phono leads. No further setup is necessary.

Connect the Control Bus Out from the 851E to the Control Bus In on the 851W. Continue the chain to other Azur models if it is required to sync more units.

Note: The 851E features a Trigger Out which can alternatively be used to control the 851W's Standby/On status if desired. Again, the procedure is simply to connect the two units together (using a 3.5mm to 3.5mm mono mini-jack lead in this case).

Control Bus connection

Control Bus is the recommended method when using an 851E and other Cambridge Audio equipment with Control Bus In/Out.

851E

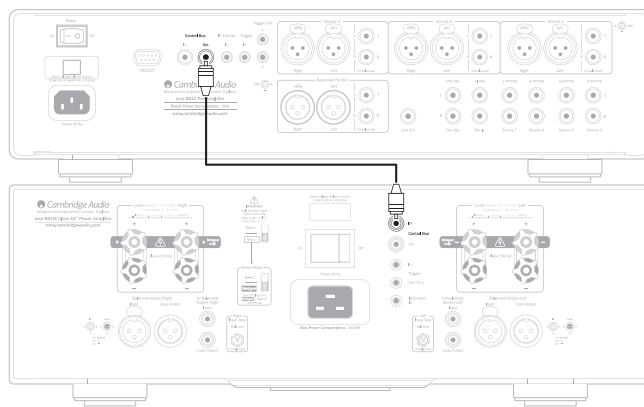

851W

Trigger connection

Trigger In/Out can be useful if the 851W (and indeed 851E) is desired to be controlled by other equipment that features trigger outputs (Custom install and/or Multi-Room Systems etc).

851E

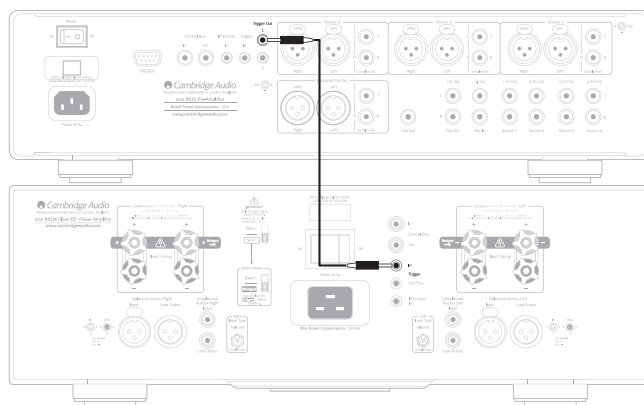

851W

Output connections - Balanced

The diagram below shows the 851E connected to an 851W using the Balanced Audio inputs via three-pin XLR connectors.

When using balanced (XLR) connections, the Left and Right Input Type switches on the 851W must be in the 'Balanced' position.

Before making any connections to the loudspeakers, make sure all power is turned off and only use suitable interconnects (e.g. banana plugs). Ensure that the positive (+) and negative (-) connections are matched.

Your loudspeaker may have more than one pair of connecting terminals; LF (Low Frequency) and HF (High Frequency). For single-wiring it is recommended to connect to the LF terminals. The metal strip connecting the low-frequency terminals to the high-frequency terminals must not be removed (only to be removed for a bi-wiring system).

Note: In this configuration the 851W must be set to Stereo mode.

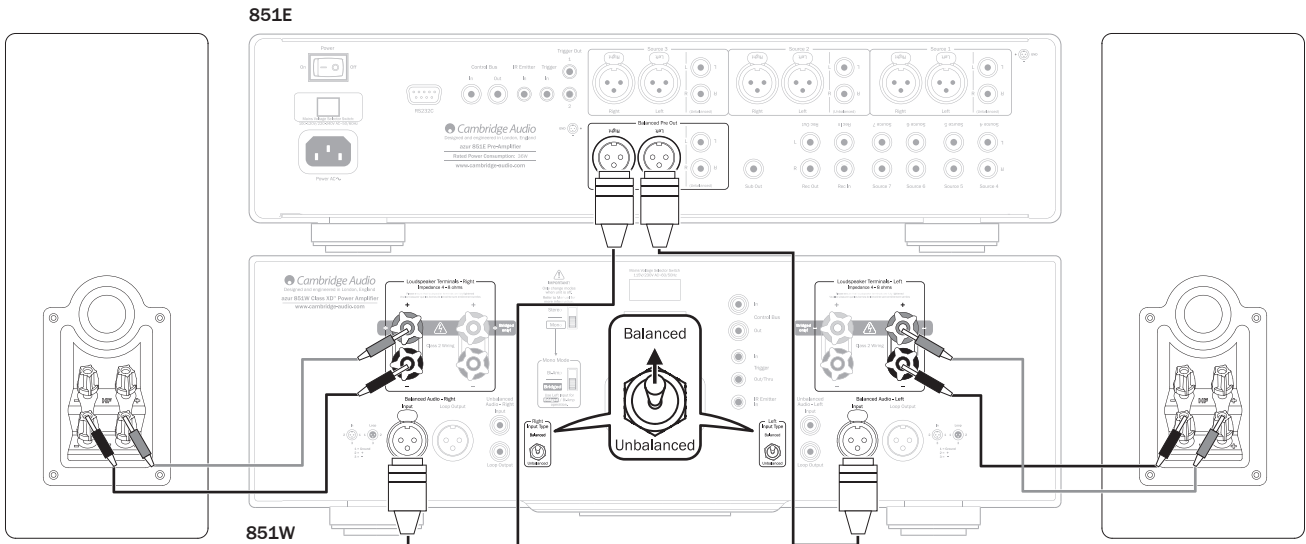

Output connections - Unbalanced

The 851E features both balanced (XLR) and unbalanced (RCA/Phono) output connections. For the best quality we recommend you use the balanced output with power amplifiers that feature this connection (such as our own 851W Class XD power amplifier).

The diagram below shows the 851E pre-amplifier connected to an Azur 851W power amplifier and a pair of loudspeakers.

When using unbalanced (phono/RCA) connections, the Left and Right Input Type switches on the 851W must be in the 'Unbalanced' position.

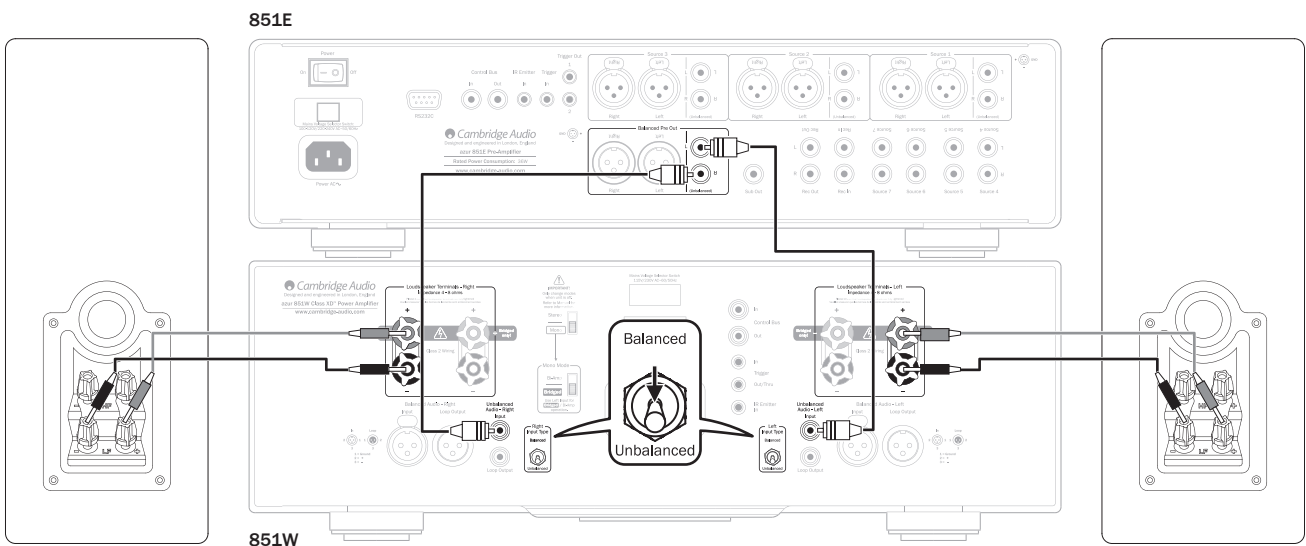

Mono Bridged connections

The matching Azur 851W power amplifier features Mono and Bridged Mono settings that allow two (or more) 851Ws to be used as mono-blocks for high end systems. Below is an example using two 851Ws in Bridged Mono with an 851E.

In Bridged Mono mode each 851W drives one speaker across its output channels acting as a 500W mono amplifier instead of a 200wpc stereo one. One 851W drives the left speaker and the other the right. See the 851W manual for full details on Bridged Mono and other possible combinations.

The example below uses balanced connections from 851E to each 851W, unbalanced connections can also be used and the principle is the same.

Important! 851W settings

Before making any connections to the loudspeakers, make sure all power is turned off and only use suitable interconnects (e.g. banana plugs). Ensure that the positive (+) and negative (-) connections are wired as shown in the diagram.

When using balanced (XLR) connections, the Left and Right Input Type switches on the 851W must be in the 'Balanced' position. When using unbalanced (phono/RCA) connections, the Left and Right Input Type switches on the 851W must be in the 'Unbalanced' position.

Only use the Left Inputs on the 851W for Bridged operation.

In this configuration the Stereo/Mono switch on the 851W must be set to 'Mono' and the Mono mode switch must be set to 'Bridged'.

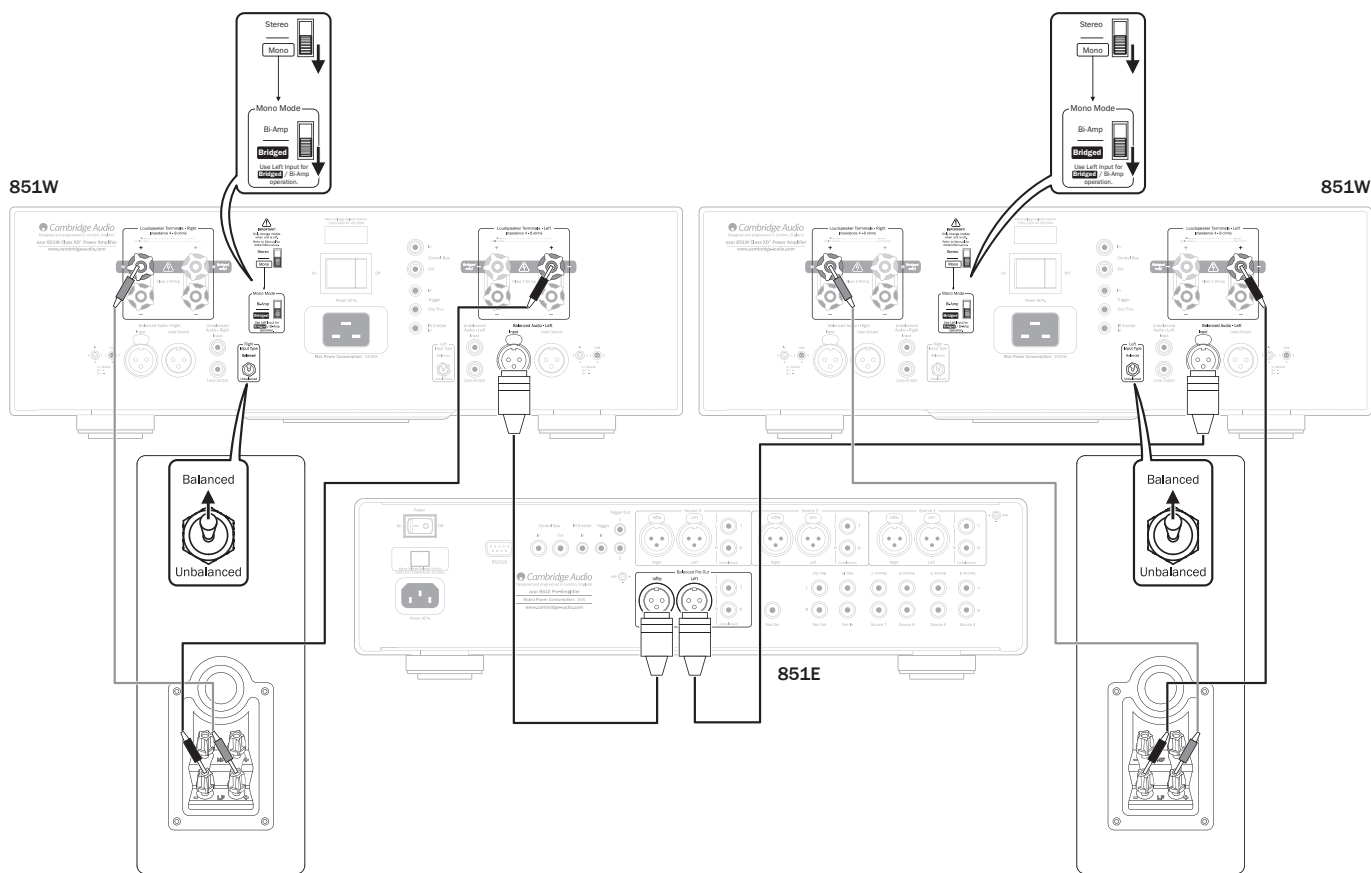

Operating instructions

The 851E has a custom-made display on the front of the unit that shows the current status and allows you to access the 851E System settings menu. Here you can adjust the listening settings of the amplifier to personal preference. The menu system is easy to navigate and control, simply by using the input select buttons to turn a feature on (solid circle) or off (no circle) and the volume control knob to increase/decrease settings.

Volume

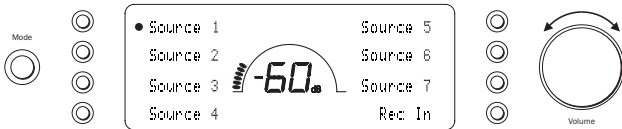

Adjust the volume control knob on the front panel (or using the remote control). The display will show the change in volume in decibels (dB). '0dB' indicates maximum volume while lower volume settings progress into the negative range. This can also be changed to arbitrary volume units (0-90) in the System settings menu.

Balance

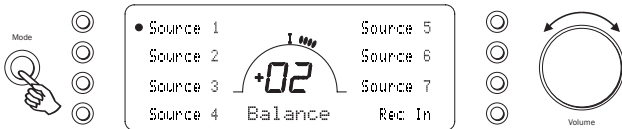

Press the Mode button to enter Balance mode. 'Balance' will appear on the display and can be adjusted using the volume control. Press the Mode button again to return to Volume mode or wait 5 seconds for the 851E to automatically exit Balance mode.

Bass and Treble

These controls allow subtle adjustments to the tonal balance of the sound. Modify the sound through your loudspeakers and the Pre-Out sockets only; they do not affect the signals sent through the Rec Out connections. With a well produced CD and a good system the tone controls are unnecessary and can be bypassed by pressing the Direct button:

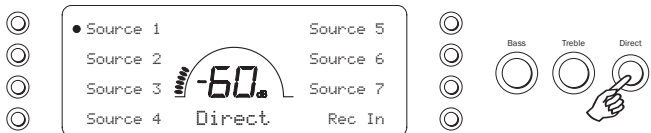

This completely removes them from the signal path for maximum fidelity. If the musical recording is of poor quality or other factors are affecting the sound quality, if desired you can adjust the tone controls to compensate. To use the tone controls press the Direct button so that the Bass/Treble icon (🎧) lights in the display indicating that they are active and direct mode is Off. Now press the Bass or Treble control button to release them and allow adjustment; push them back in when finished:

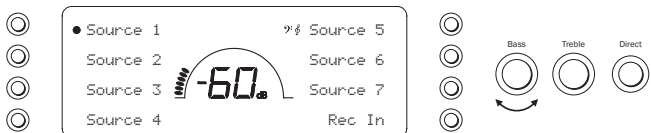

The 851E stores whether direct mode is on or off for each input individually, for example it is possible to have the tone controls automatically active for the Tuner source but not the CD source.

Pre-amplifier setup

The 851E features many advanced settings that allow its use to be customised to user preference. The inputs can be named to reflect the actual source units you have, each input can be trimmed so that each sounds the same in terms of loudness when you switch between them and other options.

Changing input names / source naming



Press and hold the relevant input select button for four seconds to access the submenu. Press the Rename button, for example, if Input 1 is a CD player, name it "CD" etc. Letters are selected by turning the volume control to scroll through the available characters. Press the Left or Right button to select which character you wish to edit. Press the Save button to save and exit the input name change menu.

System settings menu

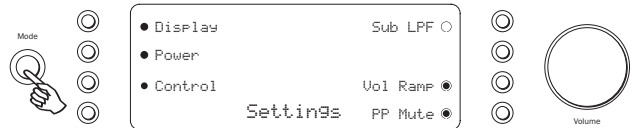

Press and hold the Mode button to access the System settings menu. The menu options are Display, Power, Control, Sub Low-Pass-Filter, Volume ramp, and Phones Presence Mute.

To exit the System settings menu and its submenus, press the Mode button again.

Display brightness



In the System settings menu press the Display input select button to enter the submenu. Press the relevant button for Enable/Disable, Bright/Dim. Press the Mode button to exit the submenu.

Sub LPF

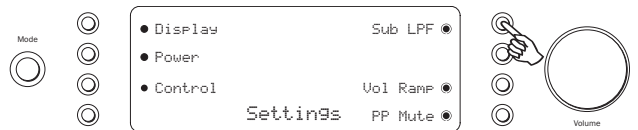

The 851E features a Sub output that is a separate mono mix created from the main pre-amp outputs. This output can have either a 'Flat' (i.e. full range, unfiltered) frequency response or a 200Hz Low Pass filter can be applied. See frequency response graph below.

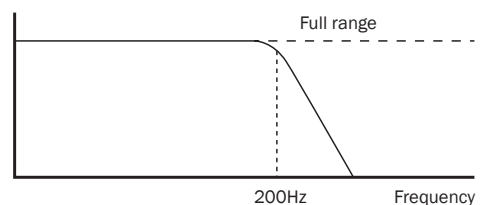

Most Subwoofers feature built in Low Pass filtering and 'Flat' is usually the best setting. This setting does not affect the main outputs which are always full-range.

To select the 200Hz LPF, press the Sub LPF input select button in the System settings menu. Press again to revert to the full range frequency response. Press the Mode button to exit the System settings menu.

Pre-amplifier setup continued

Volume ramp

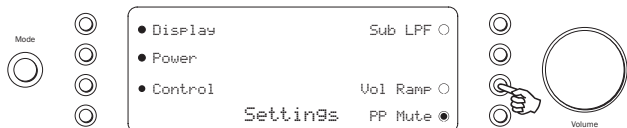

The 851E automatically ramps the volume down when going into Standby mode and up when coming out of Standby mode. To turn this feature off, press the Vol Ramp input select button in the System settings menu and set to off. Press the Mode button to exit the System settings menu.

Volume display



To change the volume display from decibels (-90 to 0dB) to arbitrary volume units (0 to 90 units) select the Vol dB input button in the Display submenu to turn off the volume in decibels. Press the Mode button to exit the submenu.

Volume trim

Note: The Volume Trim menu item is hidden if the Fixed Volume is enabled.

The relative levels of the inputs can be adjusted by gain trim. This allows each to be adjusted so that each sounds the same in terms of average loudness when you switch between them. Pick the loudest sounding source and trim its level until it matches the average perceived level of the others. Repeat this process if other sources also stand out as louder than the average.

To set the input gain trim for each source, press and hold the required input source button then select Vol Trim in the submenu:

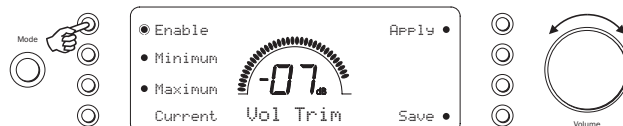

Press the Enable button and use the volume control to set the gain between 0 and -12 dB (the available range is restricted if the volume is set very low). Press the Apply button to temporarily hear the new gain settings, re-adjust the gain if necessary and press the Apply button again. Press the Save button to save and exit the submenu.

Pressing the Current button will display the current volume value. This is a useful function when setting new gain value and comparing it to the current volume.

The other two settings sets the gain as following:

Minimum – Sets the minimum value to -1dB.

Maximum – Sets the maximum gain value to -12dB.

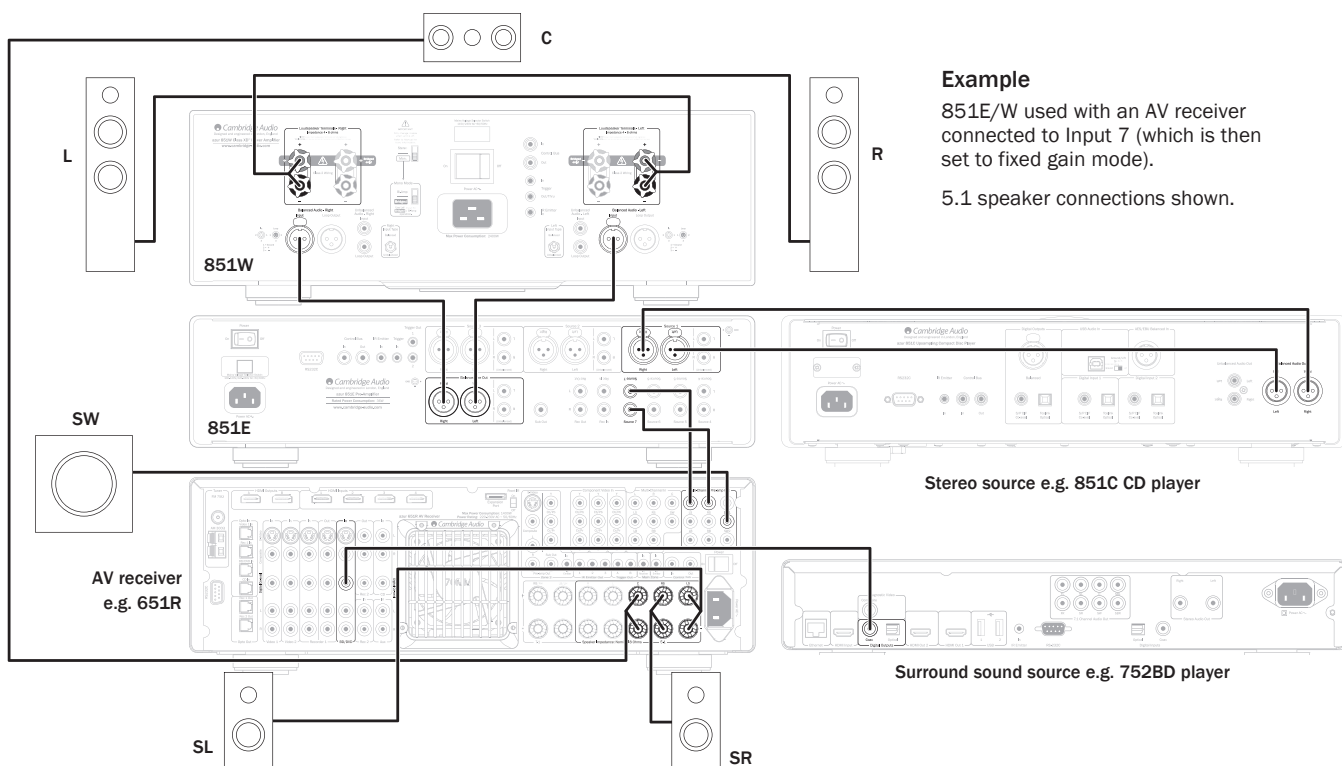

Example

851E/W used with an AV receiver connected to Input 7 (which is then set to fixed gain mode).

5.1 speaker connections shown.

Fixed volume

Any input of the 851E is able to be set for fixed gain. Whenever this input is selected the gain will automatically go to this value and will not be adjustable by the volume control. This can be useful with sources that have their own built in volume control (such as some set-top boxes etc.)

Also, this feature can be used to integrate an AV Receiver which has pre-amp outputs (such as our own 651R or 751R models) with the 851E.

The front Left and Right pre-amp outputs of the AV Receiver are simply fed to any desired input of the 851E and that input set for fixed gain. The AV receiver is then wired to the various surround speakers whilst the 851E/W drives the Front Left and Right.

The 851E/W can then be used for Stereo sources as normal for best sound quality. When it is desired to decode surround sound, select the input chosen for fixed gain on the 851E. Now the AV Receiver can be used to decode any of it's surround sound sources. It will have control of the volume of all channels and the 851E's own volume control will be disabled.

You may wish to re-name the fixed level input as "AV mode" or similar on the 851E. As the gain can be fixed to any value it is easy to match the level of the 851E to that of the other AV channels.

To set a fixed volume for a source, press and hold the required input source button then select Fixed Vol in the submenu:

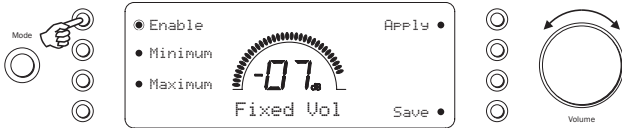

Press the Enable button and set the fixed gain using the volume control. When a source has a fixed input, the balance is always set to neutral. Press the Apply button to temporarily hear the new gain settings, re-adjust the gain if necessary and press the Apply button again. Press the Save button to save and exit the submenu.

The other two settings sets the gain as following:

Minimum – Sets the minimum fixed gain value to -90dB.

Maximum – Sets the maximum fixed gain value to 0dB.

Vol Clip

Used in conjunction with 851W via Control Bus. The 851E reduces the volume if there is a clipping notification from the 851W.

Control menu

Used in conjunction with Custom Installation (C.I.) systems or IR repeater systems, it may be desirable to disable the IR function by setting IR to off. In the System settings menu, press the Control input select button to enter the submenu. Pressing the IR input select button will scroll through the IR enabled options of Front, Back, Front + Back and IR IC (disable front and back IR). Press the Mode button to exit the submenu.

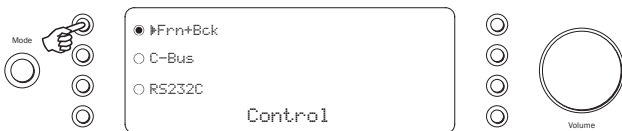

In the System settings menu, press the Control input select button to enter the submenu. Pressing the RS232C input select button will scroll through the data bit rate options of 115200b, 38400b, 9600b, and RS232C (disabled).

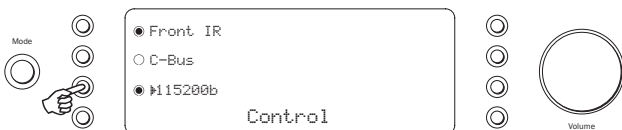

Devices menu

Note: The Device menu item is hidden if the C-Bus is disabled.

When going in/out of Standby mode the 851E can automatically turn on and off other connected Cambridge Audio Azur models that have control bus sockets. For this feature to work the units must be connected together (see diagram) by RCA/phono leads. The Control Bus sockets are colour-coded orange on the rear panels of any compatible Azur models. Connect the Control Bus Out from the 851E to the Control Bus In on another Azur model (e.g. 851W). Continue the chain to other Azur models if required.

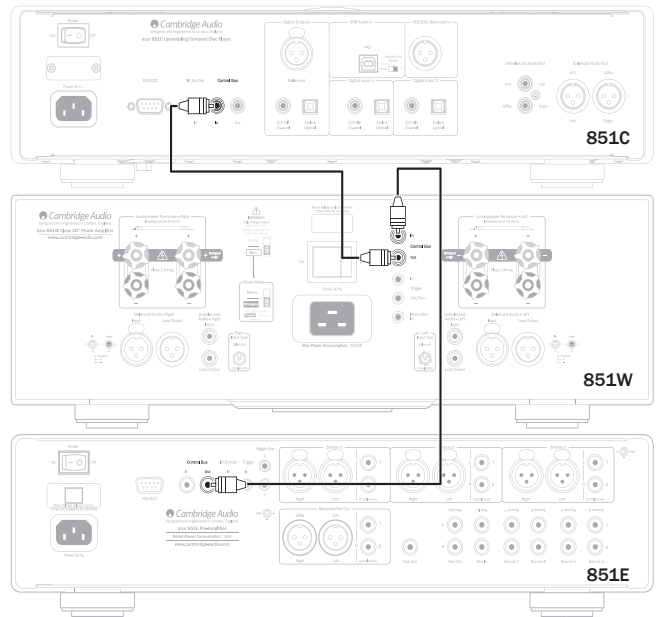

IMPORTANT! When doing a daisy-chain of other Azur models through the Control Bus, the 851E must be the main power source, otherwise it will not work.

Firstly, enable the Control Bus function. In the System settings menu, press the Control input select button to enter the submenu then press the C-Bus input select button to enable the function.

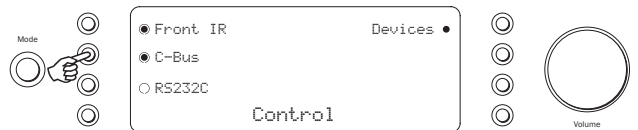

Press the Devices input select button to enter the submenu. Select the connected Azur models by pressing the appropriate input select button. For example, CA xxxC for an Azur CD player (851C), CA xxxD for an Azur DVD, CA xxxR for an Azur AV Receiver, SMx/xxxD for an Azur StreamMagic and DACs etc.

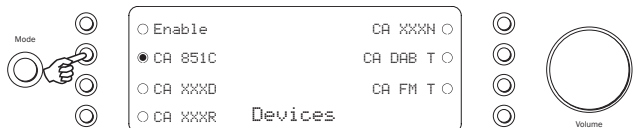

Pressing the Enable input select button to scroll through the options of On+Off (turns all Azur units on and into Standby mode), Off (turns all Azur units into Standby only), On (turns all Azur units on only), or Enable (this disables the Control Bus function).

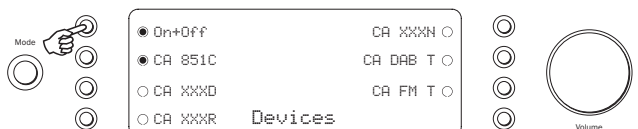

Press the Mode button to exit the submenu.

Trigger In

In the System settings menu, press the Power input select button to enter the submenu. Press the Trig In input select button to enable the function.

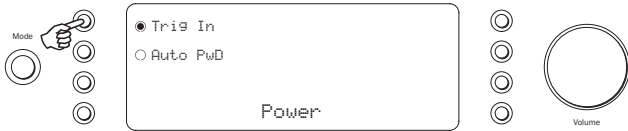

Press the Mode button to exit the submenu.

Auto Power Down (APD)

In the System settings menu, press the Power input select button to enter the submenu. Pressing the Auto PwD input select button will scroll through the options of 2 hours, 1 hour, 30 mins, 15 mins, 10 mins, 5 mins and Auto PwD (disabled).

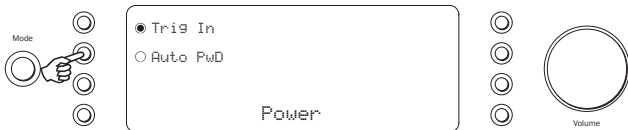

Press the Mode button to exit the submenu.

CAP5: Five-way protection system

Cambridge Audio has developed a proprietary protection system to ensure reliability and long life of its amplifiers.

When the 851E and the 851W are paired, if any, the 851E can detect errors from the 851W and an error notification will flash briefly on the 851E LCD display.

To achieve this, connect the 'Control Bus Out' from the 851W to the 'Control Bus In' on the 851E.

851E

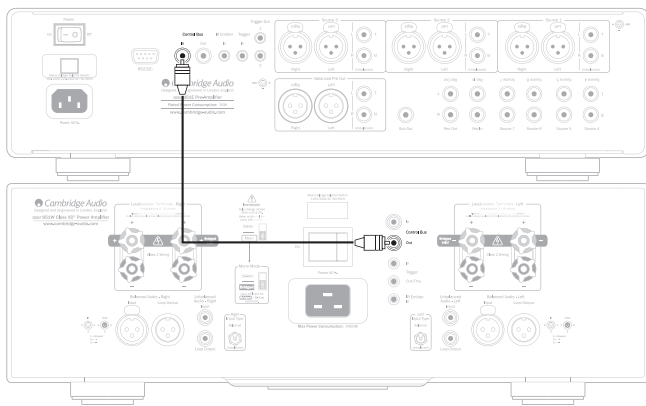

851W

This protection system comprises five main protection methods:

1. W DC Offset – DC detection

Indicator – Unit has switched off during operation.

Description – CAP5 offers loudspeaker protection if the output of the amplifier goes to a high constant voltage (DC). This is a rare fault, although detecting it could just save those expensive loudspeakers.

Remedy – Due to the necessary sensitivity of the DC protection circuit, hard clipping of the amplifier may cause DC protection to be triggered. If this fault occurs please switch the unit off, power up again and check operation with a reduced volume level. If the DC fault occurs again please contact your dealer for service.

2. W Overtemp – Over temperature detection

Indicator – Unit has switched off during operation.

Description – CAP5 includes temperature detection which constantly monitors the heat generated by the output transistors. If the monitored temperature reaches a high level (suitably within the limits of the output devices) the amplifier will automatically switch into a fault mode. If the loudspeaker impedance is low, the temperature of the amplifier may rise faster as the amplifier is working harder. If the amplifier is mounted in a cabinet or the ventilation slots are obstructed, the over-temperature detection may activate/reactivate after a short listening time.

Remedy – The unit is not damaged, although it should be left for 15 minutes to cool down before being switched out of Standby.

3. W Overload – Overvoltage/overcurrent detection

Indicator – Unit has switched off during operation.

Description – CAP5 offers V/I protection by constantly monitoring the output transistors to keep them working inside their Safe Operating Area (SOA). The SOA is a set of limits given by the output transistor manufacturer to ensure reliability. V/I also protects the amplifier against short-circuits on the speaker terminals during use.

Remedy – The amplifier is being used outside its performance envelope. Reduce the volume. Also check to see if there is a short- or partial short-circuit between the loudspeaker terminals.

Note: If the indication remains the same and multiple loudspeakers are being used on each loudspeaker output, then please remove a pair and retry. If too many loudspeakers are connected to any amplifier, causing the load resistance to drop too low, the amplifier will be overdriven. CAP5 will detect this situation. If the indication remains the same with only one set of loudspeakers connected, there may be a fault with one or both of the loudspeakers.

4. W Skp shrt – Short-circuit detection

Indicator – As the unit attempts to come out of Standby mode.

Description – During power up from Standby, CAP5 performs a check on the loudspeaker terminals to see if a short across the terminals has been accidentally introduced. If the resistance measured across the loudspeaker terminals is too low, the unit will remain in Standby mode until the fault has been removed and power up is re-attempted.

Remedy – User-related fault. There may be a short-circuit between the loudspeaker terminals. Check all loudspeaker connections before attempting to switch the unit out of Standby.

5. W Clipping – Intelligent clipping detection

Indicator – Volume is nudged down automatically. Note that this automatic function will only work if the 'Vol Clipping' is enable in the Input sub menu.

Description – CAP5 has the ability to detect when the amplifier starts to clip or overdrive at its output, which can damage loudspeakers and degrade the sound. Clipping distortion is caused at high volume levels when the output signal briefly goes outside the maximum voltage that the amplifier can provide, causing the tops of the signal to flatten off. When CAP5 detects clipping, the volume will be automatically nudged down until CAP5 detects an undistorted output.

The clipping detection is disabled by default. However, to enable the clipping detection, hold down the Standby/On button during power up (whilst switching on the unit at the rear panel power switch). The unit will indicate this by flashing the protection LED for several seconds.

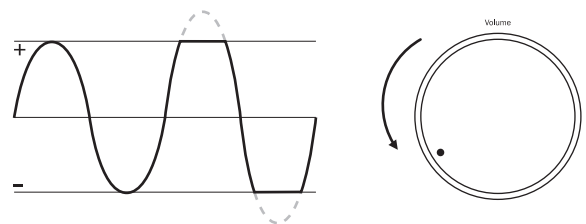

Custom installation (C.I.) use

The 851E features a Control Bus input/output that allow un-modulated remote control commands (positive logic, TTL level) to be received electrically by the unit and looped to another unit if desired. These control commands are typically generated by custom installation (multi-room) systems or remote IR receiver systems. The Control Bus sockets are colour-coded orange.

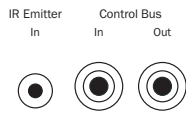

An IR Emitter Input is also provided that allows modulated IR remote control commands to be received electrically by the unit. Commands on this input operate the unit only and are not looped out demodulated on the Control Bus Output.

An RS232C port is also featured which allows the 851E to be controlled by C.I. systems.



In addition the unit features 'direct' IR/Control codes as well as toggle codes for some of their features to simplify programming custom installation systems. Special direct On/Off and Mute commands can be accessed on the supplied remote control for coding into C.I. systems as follows:

1. Press and hold the Standby/On button. The remote first generates its standby (toggle) command. Keep the button held down, after 12 seconds an amplifier "On" command will be generated. If the button is kept held down for a further 12 seconds, an "Off" command is generated.
2. Press and hold the Mute button. The remote first generates its mute (toggle) command. Keep the button held down, after 12 seconds a "Mute on" command will be generated. If the button is kept held down for a further 12 seconds, a "Mute off" command is generated.

A full code table and RS232 protocol for this product is available on the Cambridge Audio website:

www.cambridge-audio.com

Technical specifications

THD (+ noise)	< 0.00045% @1kHz < 0.00057% @20kHz
S/N (unweighted)	< 110dB < 90dBu
Frequency response	10Hz - 100kHz ± 0.1dB
Crosstalk @1kHz	> 95dB
Input isolation	> 110dB
Maximum output	8V rms unbalanced 8V + 8V rms balanced
Output impedance	100 Ohms (Unbalanced or Balanced)
Subwoofer out	Flat or 200Hz 2nd Order Butterworth LPF
Max power consumption	36W
Bass & Treble controls	Shelving type Max bass boost/cut ± 10 dB at 10 Hz Max treble boost/cut ± 7.5 dB at 20 kHz
Dimensions (H x W x D)	115 x 430 x 385mm (4.5 x 16.9 x 15.2")
Weight	8.1kg (17.9Lbs)

Troubleshooting

There is no power

- Ensure the AC power cord is connected securely.
- Ensure the plug is fully inserted into the wall socket and is switched on.
- Check fuse in the mains plug or adaptor.
- Make sure that the on/off switch at the back of the unit is turned on

There is no sound

- Make sure the unit is not in Standby mode.
- Check that source component is properly connected.
- Check that REC IN is not switched on (unless record input is required).
- Check that your speakers are properly connected.
- Make sure unit is not in mute mode.
- If using Balanced connection ensure balanced input is selected, indicated by a ring around the input indicator circle on the display

There is no sound on one channel

- Ensure that balance control is in the correct position.
- Check speaker connections.
- Check interconnects.

There is a loud buzz or hum

- Check turntable or tone arm for ground and connection lead fault.
- Ensure no interconnects are loose or defective.
- Ensure that your tape deck/turntable is not too close to the unit.

Unable to make or play tape recordings

- Check that Record In and Record Out have been connected correctly.

There is weak bass or diffused stereo imaging

- Ensure that speakers are not wired out of phase.

The remote handset will not function

- Check that the batteries have not expired.
- Ensure that nothing is blocking the remote sensor.
- Ensure IR receiver has not been disabled in system menu.

For more frequently asked questions (FAQs), technical advice and information on getting the most out of your 851E, please visit the Support section on Cambridge Audio's website:

www.cambridgeaudio.com/support.php

For all servicing, in or out of warranty, please contact your dealer.

Cambridge Audio is a brand of Audio Partnership Plc
Registered Office: Gallery Court, Hankey Place
London SE1 4BB, United Kingdom
Registered in England No. 2953313

www.cambridge-audio.com

