

 **Cambridge Audio**

Your music + our passion

Contents

Introduction.....	3
System setup.....	4
Installation notes.....	6
Keypad overview.....	8
On-screen display.....	9
Cloning from the remote control.....	10
Settings menus.....	13
Troubleshooting.....	18
Limited warranty.....	19

Introduction

Thank you for purchasing this Cambridge Audio Incognito product. Incognito is a cost-effective, modular based multi-room system using standard Cat-5/5e or Cat-6 cable to distribute hi-fi quality sound around a home. Optionally, video can also be distributed using co-axial cable and a VH10 video hub.

The LK10 in-wall learning keypad must be used with the Incognito KP10 A-BUS™ audio keypad and LR10 learning remote.

The LK10 keypad clones learnt IR codes and macros from the LR10 remote which once transferred allow the LK10 to be used to control your source equipment conveniently from the wall.

The LK10 is fitted on the wall by fixing it into a standard double J-box electrician's back-box and double Decora™ style faceplate (not included) next to a KP10 keypad. All knock-outs in the back-box should be removed to provide maximum ventilation. Care should be taken in choosing a site for the LK10, always refer to the precautions in this guide.

Thank you for taking the time to read this manual, we do recommend you keep it for future reference.



Matthew Bramble, Cambridge Audio Technical Director
and the LK10 design team.

System setup

To add your LK10 keypad into your Incognito system, refer to the diagram below:

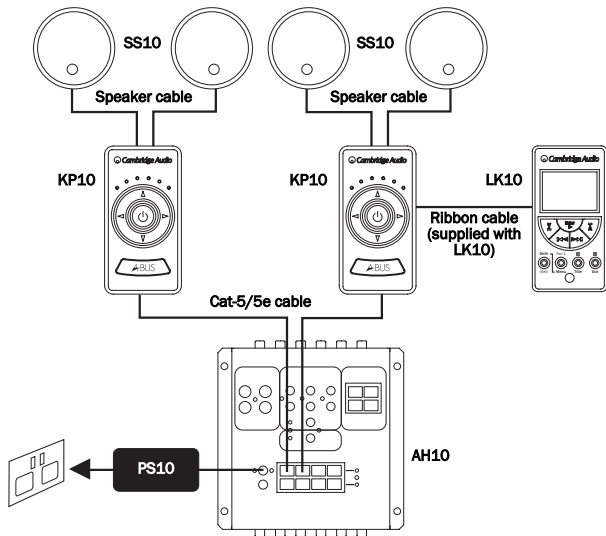

Important: LK10 will only operate when connected to KP10 as part of a complete AH10 hub-based system. It is not compatible with 'Incognito Ready' amplifiers.

The LK10 should be placed next to the KP10, using a double J-Box and double Decora™ faceplate (not supplied).

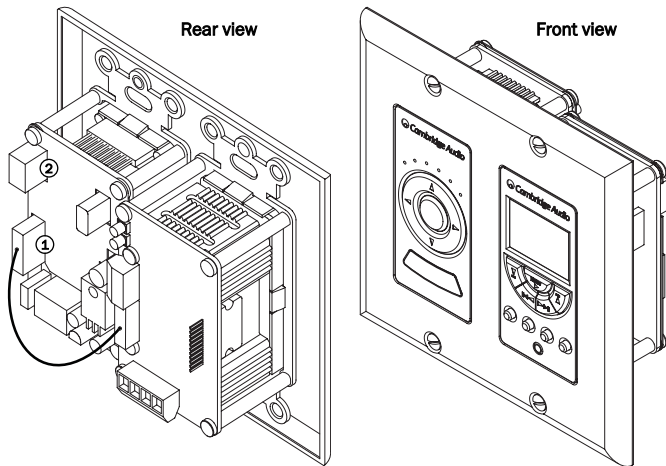

- ① **KP10 connector** - Connects the LK10 to the KP10 with the supplied ribbon cable.
- ② **I.C.P.** - In-circuit programming socket, used to upgrade keypad software when necessary.

Installation notes

The LK10 is fitted on the wall by fixing it into a double USA-type J-Box (electrician's back-box). All knock-outs in the back-box should be removed to provide maximum ventilation.

Where it is desired to fit a mains lighting switch etc next to a keypad, a barrier-box or two single back-boxes must be used (bear in mind it is not preferable to fit the keypad next to a light-switch particularly if the faceplate styles will differ). Only a qualified electrician should attempt such installations.

Avoid fitting the LK10/KP10 where there is line of sight to another LK10/KP10. In such situations both keypads may pick up the same commands from a remote control and it will be difficult to control each zone independently.

Avoid fitting the LK10/KP10 where there is line of sight to the source equipment for the system. In such situations the source equipment may pick up the same IR commands directly as are picked up by the keypad and sent to the source equipment. This can interfere with the remote operation of the source equipment.

Do not fit the keypad in areas directly lit by strong sunlight or where it will be strongly lit by fluorescent tubes. These can be sources of infra-red energy which can interfere with the remote control operation of the system. Some plasma televisions can radiate a lot of infra-red energy and care should be taken if fitting a LK10/KP10 near a plasma screen television. Avoid placing the LK10/KP10 near to dimmer switches or other items, which generate a lot of electrical noise.

Safety precautions

Care should be taken when choosing the site for a LK10; the keypad must never be installed in a back-box which also contains mains wiring or in areas of high humidity.

Power requirement



The LK10 runs on 24V DC (@ 250mA max) supplied through the connecting cable from the KP10 keypad. As such there is no mains voltage present in the KP10 and the unit is often safe to fit in areas where only extra low voltage (ELV) equipment is permitted. However, it is imperative that you always check the wiring regulations in force for your application and area.

Faceplates

The LK10 faceplate system is based on the Decora™ standard and is interchangeable with the wide range of faceplates made by manufacturers such as Leviton etc that conform to this standard. If it is desired to fit another faceplate, it can be replaced by gently prising apart the LK10 faceplate and snapping on another in its place.

Approvals

 This product complies with European Low Voltage (73/23/EEC) and Electromagnetic Compatibility (89/336/EEC) Directives when used and installed according to this instruction manual. For continued compliance only Cambridge Audio accessories should be used with this product and servicing must be referred to qualified service personnel.

 The crossed-out wheeled bin is the European Union symbol for indicating separate collection for electrical and electronic equipment. This product contains electrical and electronic equipment which should be reused, recycled or recovered and  should not be disposed of with unsorted regular waste. Please return the unit or contact the authorised dealer from whom you purchased this product for more information.

Keypad overview

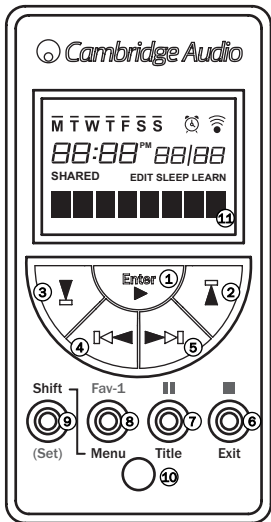

Buttons numbered 1-8 have dual functions, which are controlled by the *Shift* button. These buttons generate IR codes or macros cloned from the buttons of the same name on the LR10 learning remote (see later section on Cloning).

Primary functions

- ① Play
- ② Skip forward
- ③ Skip backward
- ④ Scan backward
- ⑤ Scan forward
- ⑥ Stop
- ⑦ Pause
- ⑧ Fav-1 (Favourite)
- ⑨ Set (Settings)
- ⑩ Cloning port
- ⑪ Display screen

Secondary functions

- Enter
- Up
- Down
- Left
- Right
- Exit
- Title
- Menu
- Shift

Note: The actual functions of the buttons are completely dependent on the codes taught into the LR10 remote.

For full instructions on Shift/Settings, learning buttons and the cloning port, please refer to the 'Operating instructions' and 'Keypad setup' sections of this guide.

On-screen display

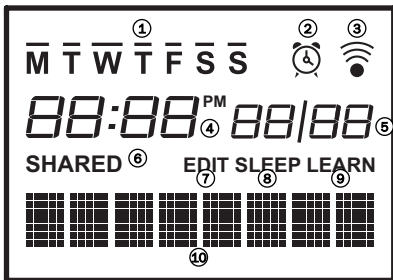

- ① **Week days** - The bar over a letter indicates the day of the week.
- ② **Alarm** - Displayed when the alarm function is set.
- ③ **IR** - Indicates when an infra-red signal is sent from the LK10.
- ④ **Time** - Displays current time. 'PM' appears when 12 hour clock is set.
- ⑤ **Date** - Can be set as Month/Date or Date/Month.
- ⑥ **Shared** - Displayed when sharing a source with another zone connected to the same AH10 hub.
- ⑦ **Edit** - Displayed when in Edit mode (Settings menu).
- ⑧ **Sleep** - Displayed when the sleep function is set.
- ⑨ **Learn** - Displayed when in Learn/Clone mode.
- ⑩ **Name bar** - Displays the name of the source, button or function.

For full instructions on these functions, please refer to the 'Keypad setup' section of this guide.

Cloning from the remote control

The LK10 can only be used to control source equipment once it has been cloned from the LR10. This transfers the necessary IR codes and macros into the LK10. The Incognito LR10 is a sophisticated learning remote which is able to learn the codes of all the source equipment from their own remotes.

Once the LR10 itself has been programmed the user can clone all macros and programmed information from the LR10 to the LK10, allowing the keypad to also perform the same operations (IR codes, macros, button names and clock settings).

Note: Only the learning buttons highlighted on the remote are cloned to the LK10.

Please refer to the LR10's own manual for full details on how to teach codes into the LR10, advice on macros etc. Once the LR10 is fully programmed/setup, you can clone it into the LK10.

To begin cloning, plug the supplied connection cable into the cloning port on the LK10 and LR10, then put the LK10 into Learn mode.

Set the LR10 to transmit (the LK10 will default to Receiving mode).

On the back of the LR10 press the *Edit* button 4 times (using a paperclip or similar) to enter Clone mode. 'REC/TRX' will appear on both displays.

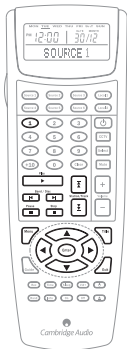
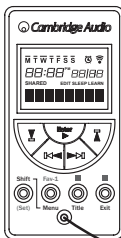

For the LK10 to receive commands, it must be first put into Learn mode. The LK10 has a series of menus that can be accessed by pressing and holding the *Shift/Set* button on the front panel. The menu options are continuously scrolled on the LK10 display until you release the *Shift/Set* button.

Follow the next steps to complete the cloning operation:

LK10 keypad - Receiving data

LR10 remote - Transmitting data

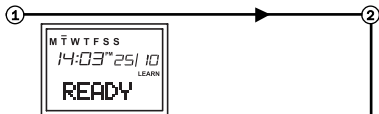

1. Press and hold the Set button for five seconds. When 'LEARN' is displayed, release the button. 'READY' will then be displayed on screen.



2. Press the ◀ button on the remote until 'TRX' is flashing.

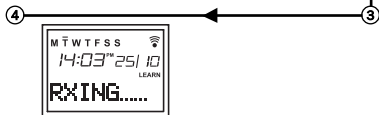

4. 'RXING..' will then be displayed, to indicate it is receiving data.



3. Press the Enter button on the remote. Display shows 'SENDING'.

Cloning from the remote control

After approximately 7 minutes the keypad display should show 'COMPLETE' and return to normal operation. All data has been transferred.

If the clone fails the keypad will show 'ERROR' or 'TIMEOUT'. Put the transmitting LR10 remote back into Clone mode and repeat the process.

Note: Once the cloning process has been started it must be completed, as it overwrites the software in the receiving LK10 keypad.

Settings menus

Note: You still use your KP10 keypad to control audio functions (volume adjustment, source selection etc).

To personalise other settings of the LK10, press and hold the Set button for four seconds to activate the Settings menus (Fig. 1). The LK10 screen will continuously scroll through the five menu options:

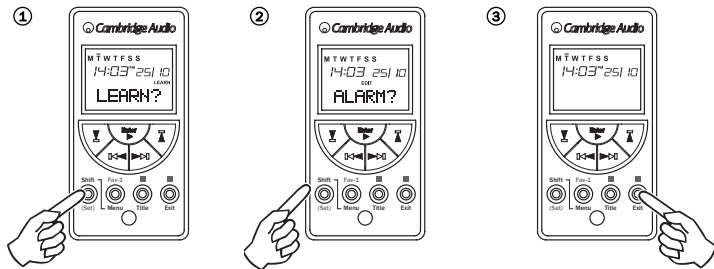
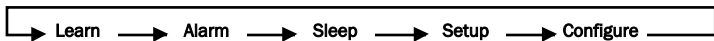

To select the option you require release the button when the menu option is displayed on the screen (Fig. 2).



To return, press *Exit* (Fig. 3). Any changes you have made will be saved.



Settings menus

Alarm menu

Press the Set button for five seconds and release when 'ALARM?' is displayed on the screen.



Use the  and  buttons to navigate the menu.

Use the  and  buttons to adjust the desired option.

Note: When a Source is selected, it will display the default Source programmed into the KP10 keypad.

Days

When selecting 'DAYS', use the  and  keys to scroll to single day, Monday to Friday, weekend or everyday.

\bar{M} T W T F S S
 \bar{M} \bar{T} \bar{W} \bar{T} \bar{F} S S
 M T W T F \bar{S} \bar{S}

On/Off

When the alarm is selected on, the Alarm icon  will appear on the display.

Sleep menu

This menu allows you to set the time at which the LK10 will automatically switch off. Press the Set button for five seconds and release when 'SLEEP?' is displayed on the screen.



Use the ◀◀ and ▶▶ buttons to navigate the menu.

Use the ▲ and ▼ buttons to adjust the desired option.

Settings menus

Setup menu

This menu lets the user manually set the time and date of the LK10. Press the Set button for five seconds and release when 'SETUP?' is displayed on the screen.

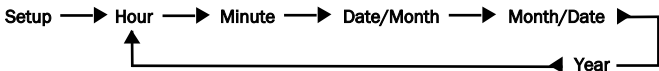

Use the ◀◀ and ▶▶ buttons to navigate the menu.

Use the ▲ and ▼ buttons to adjust the desired option.

Note: The time and date will also be set automatically after a download from the LR10.

Configure menu

Press the Set button for five seconds and release when 'CONFIG?' is displayed on the screen.

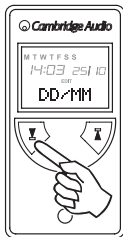
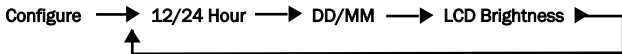

Use the [◀] and [▶] buttons to navigate the menu.

Use the ▲ and ▼ buttons to adjust the desired option.

12/24 Hour - Controls the clock display in either 12 or 24 hour format.

DD/MM - Sets the order in which the date and month are displayed.

LCD Brightness - Controls the LCD brightness level; Bright, dim or off.

Troubleshooting

If the LK10 becomes locked and/or 'ERROR' appears on the display due to a power interruption or during cloning, follow these steps:

1. Unplug the power to the system and plug back in after one minute.
2. When the power resumes, the LK10 will display distorted text.
3. Clone the LR10 to the LK10 **without** entering Learn mode.
4. When the LR10 has finished sending, repeat Step 1.

Note: Time and date will not be updated in the LK10.

Important: LK10 will only operate when connected to KP10 as part of a complete AH10 hub-based system. It is not compatible with 'Incognito Ready' amplifiers.

Visit www.cambridge-audio.com and register to receive notification of future hardware and software releases.

This guide is designed to make installing and using this product as easy as possible. Information in this document has been carefully checked for accuracy at the time of printing; however, Cambridge Audio's policy is one of continuous improvement, therefore design and specifications are subject to change without prior notice. If you notice any errors please feel free to email us at: support@cambridgeaudio.com

This document contains proprietary information protected by copyright. All rights are reserved. No part of this manual may be reproduced by any mechanical, electronic or other means, in any form, without prior written permission of the manufacturer. All trademarks and registered trademarks are the property of their respective owners.

Incognito and Incognito Ready are trademarks of Cambridge Audio Ltd. All rights reserved.

© Copyright Cambridge Audio Ltd 2009

A-BUS and A-BUS Ready are registered trademarks of LeisureTech Electronics Pty Ltd Australia. This product may be covered by one of more of the following patents: US 7,181,023, 6,389,139, EP 1004222, AU 739808, NZ 502982, Mexico Z41196, Canada CA2301062.

Limited warranty

Cambridge Audio warrants this product to be free from defects in materials and workmanship (subject to the terms set forth below). Cambridge Audio will repair or replace (at Cambridge Audio's option) this product or any defective parts in this product. Warranty periods may vary from country to country. If in doubt consult your dealer and ensure that you retain proof of purchase.

To obtain warranty service, please contact the Cambridge Audio authorised dealer from which you purchased this product. If your dealer is not equipped to perform the repair of your Cambridge Audio product, it can be returned by your dealer to Cambridge Audio or an authorised Cambridge Audio service agent. You will need to ship this product in either its original packaging or packaging affording an equal degree of protection.

Proof of purchase in the form of a bill of sale or receipted invoice, which is evidence that this product is within the warranty period, must be presented to obtain warranty service.

This warranty is invalid if (a) the factory-applied serial number has been altered or removed from this product or (b) this product was not purchased from a Cambridge Audio authorised dealer. You may call Cambridge Audio or your local country Cambridge Audio distributor to confirm that you have an unaltered serial number and/or you purchased from a Cambridge Audio authorised dealer.

This warranty does not cover cosmetic damage or damage due to acts of God, accident, misuse, abuse, negligence, commercial use, or modification of, or to any part of, the product. This warranty does not cover damage due to improper operation, maintenance or installation, or attempted repair by anyone other than Cambridge Audio or a Cambridge Audio dealer, or authorised service agent which is authorised to do Cambridge Audio warranty work. Any unauthorised repairs will void this warranty. This warranty does not cover products sold AS IS or WITH ALL FAULTS.

REPAIRS OR REPLACEMENTS AS PROVIDED UNDER THIS WARRANTY ARE THE EXCLUSIVE REMEDY OF THE CONSUMER. CAMBRIDGE AUDIO SHALL NOT BE LIABLE FOR ANY INCIDENTAL OR CONSEQUENTIAL DAMAGES FOR BREACH OF ANY EXPRESS OR IMPLIED WARRANTY IN THIS PRODUCT. EXCEPT TO THE EXTENT PROHIBITED BY LAW, THIS WARRANTY IS EXCLUSIVE AND IN LIEU OF ALL OTHER EXPRESS AND IMPLIED WARRANTIES WHATSOEVER INCLUDING, BUT NOT LIMITED TO, THE WARRANTY OF MERCHANTABILITY AND FITNESS FOR A PRACTICAL PURPOSE.

Some countries and US states do not allow the exclusion or limitation of incidental or consequential damages or implied warranties so the above exclusions may not apply to you. This warranty gives you specific legal rights, and you may have other statutory rights, which vary from state to state or country to country.

For any service, in or out of warranty, please contact your dealer.

www.cambridge-audio.com

Cambridge Audio is a brand of Audio Partnership Plc

Registered Office:

Gallery Court, Hankey Place,

London SE1 4BB, United Kingdom

Registered in England No. 2953313



© 2009 Cambridge Audio Ltd

AP20830/2