

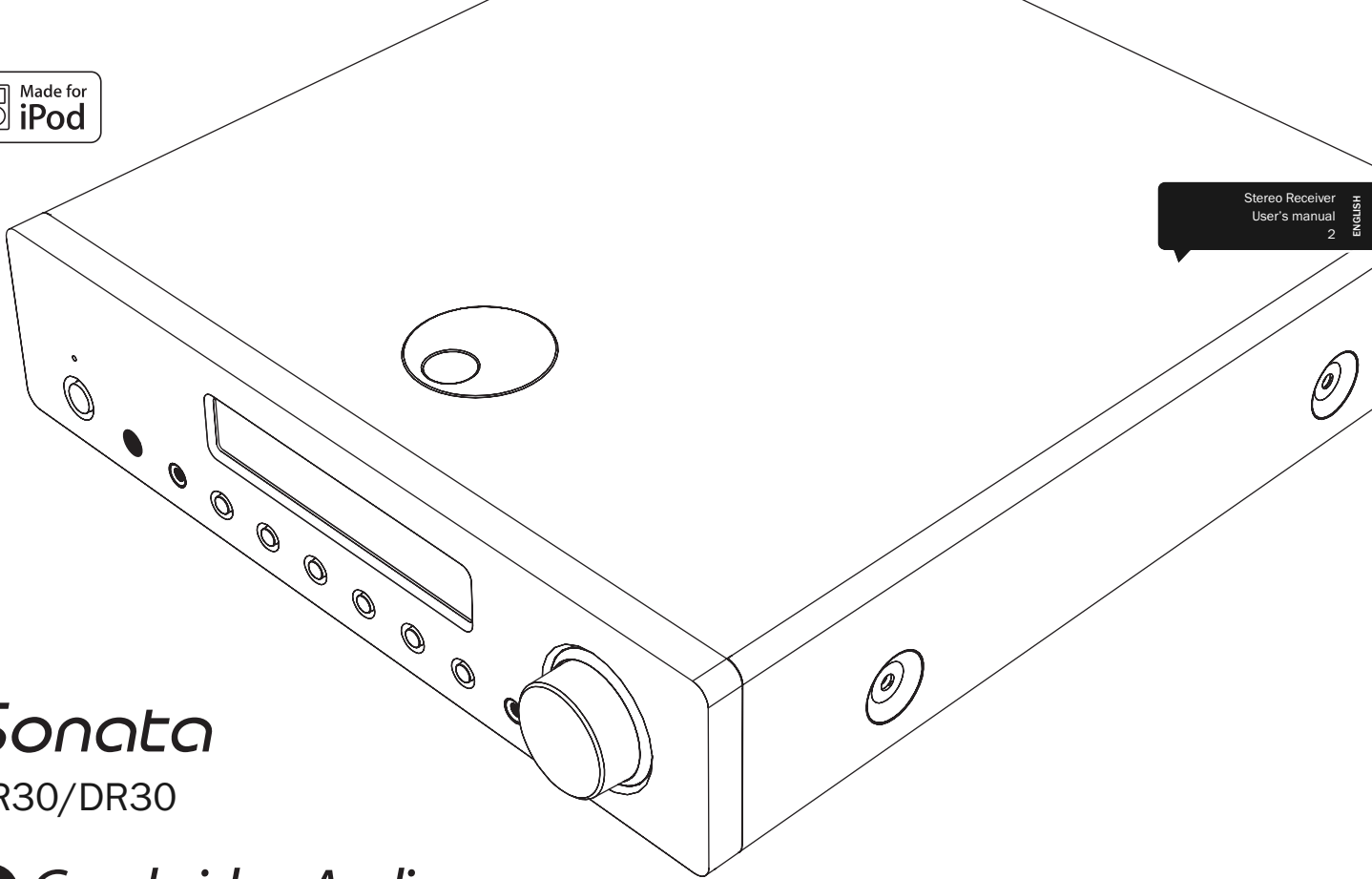

Sonata

AR30/DR30

 *Cambridge Audio*
Your music + our passion



Make sure you register your purchase.

Visit: www.cambridge-audio.com/sts

By registering, you'll be the first to know about:

- **Future product releases**
- **Software upgrades**
- **News, events and exclusive offers plus competitions!**

This guide is designed to make installing and using this product as easy as possible. Information in this document has been carefully checked for accuracy at the time of printing; however, Cambridge Audio's policy is one of continuous improvement, therefore design and specifications are subject to change without prior notice.

This document contains proprietary information protected by copyright. All rights are reserved. No part of this manual may be reproduced by any mechanical, electronic or other means, in any form, without prior written permission of the manufacturer. All trademarks and registered trademarks are the property of their respective owners.

© Copyright Cambridge Audio Ltd 2009

iPod is a trademark of Apple Inc., registered in the U.S. and other countries.

"SIRIUS" and the SIRIUS dog logo are registered trademarks of SIRIUS Satellite Radio Inc.

Contents

Introduction	3
Important safety instructions	4
Limited warranty	7
Rear panel connections.....	8
Front panel controls.....	10
Remote control.....	12
iPod compatibility	13
Connections	14
Aerials.....	15
Operating instructions.....	16
Changing DAB region (DR30 only)	16
Setting the source.....	16
Adjusting the volume	17
Adjusting the audio settings.....	17
Tuning and listening.....	17
Setting presets.....	18
Setting the clock	19
Setting the time zone (US version only)	19
Setting the alarm	20
Setting the sleep time	20
Advanced settings.....	21
To re-name the Aux input	21
Using the supplied DD30 docking station for iPod	22
iPod compatibility	22
Connecting and using a SIRIUS Connect Home Tuner (US version only).....	23
Factory reset	24
Troubleshooting.....	24
Technical specifications	25

Introduction

Thank you for purchasing your Sonata AR30/DR30. We are confident that you will enjoy many years of listening pleasure from it. Like all Cambridge Audio products, the Sonata AR30/DR30 adheres to three core principles – stunning performance, ease of use and incredible value.

The Sonata AR30 and DR30 were jointly developed to offer truly uncompromised audiophile quality audio in a small convenient and stylish package. The Sonata AR30 is a stereo receiver featuring high quality amplification with an in-built FM/AM tuner and supplied DD30 docking station for iPod. The US version of the AR30 additionally features a SIRIUS-Ready socket to allow satellite radio to be added in that country (requires a SIRIUS subscription).

The Sonata DR30 is an alternative stereo receiver featuring the same amplification and DD30 iPod dock but with a DAB/FM tuner for countries which broadcast DAB digital radio.

The supplied remote can control all of the Sonata AR30/DR30's functions and those of an iPod when docked in the matching DD30 dock (supplied).

The audio circuitry draws on all our previous experience and features a true discrete high power amplifier, linear power supply and low flux toroidal transformer. Alarm and Sleep timer functions are available and you may choose to wake to the Tuner or attached iPod. A temporary aerial is supplied to get you going, however the use of appropriate external AM/FM/DAB aerials is strongly recommended to really get the best from your Sonata AR30/DR30.

Ultimate sound quality depends on the whole of your system, naturally we particularly recommend speakers from the Cambridge Audio Sirocco range as these have been designed for a perfect acoustic and aesthetic match. Your dealer can also supply excellent quality Cambridge Audio interconnects to ensure your system realises its full potential.

Thanks for taking the time to read this manual; we do recommend you keep it for future reference.



Matthew Bramble
Cambridge Audio Technical Director and the Sonata range development team

Important safety instructions

For your own safety please read the following important safety instructions carefully before attempting to connect this unit to the mains power supply. They will also enable you to get the best performance from and prolong the life of the unit:

1. Read these instructions.
2. Keep these instructions.
3. Heed all warnings.
4. Follow all instructions.
5. Do not use this apparatus near water.
6. Clean only with a dry cloth.
7. Do not block any ventilation openings. Install in accordance with the manufacturer's instructions.
8. Do not install near any heat sources such as radiators, heat registers, stoves, or other apparatus (including amplifiers) that produce heat.
9. Do not defeat the safety purpose of the polarized or grounding-type plug. A polarized plug has two blades with one wider than the other. A grounding-type plug has two blades and a third grounding prong. The wide blade or the third prong are provided for your safety. If the provided plug does not fit into your outlet, consult an electrician for replacement of the obsolete outlet.
10. Protect the power cord from being walked on or pinched, particularly at plugs, convenience receptacles and the point where they exit from the apparatus.
11. Only use attachments/accessories specified by the manufacturer.
12. Use with only the cart, stand, tripod, bracket, or table specified by the manufacturer, or sold with the apparatus. When a cart is used, use caution when moving the cart/ apparatus combination to avoid injury from tip-over.
13. Unplug this apparatus during lightning storms or when unused for long periods of time.



14. Refer all servicing to qualified service personnel. Servicing is required when the apparatus has been damaged in any way, such as the power-supply cord or plug having been damaged, liquid has been spilled or objects have fallen into the apparatus, the apparatus has been exposed to rain or moisture, does not operate normally, or has been dropped.

WARNING

- To reduce the risk of fire or electric shock, do not expose this unit to rain or moisture.
- Batteries (battery pack or batteries installed) shall not be exposed to excessive heat such as sunshine, fire or the like.

The unit must be installed in a manner that makes disconnection of the mains plug from the mains socket outlet (or appliance connector from the rear of the unit) possible. Where the mains plug is used as the disconnect device, the disconnect device shall remain readily operable. Only use the mains cord supplied with this unit.

Please ensure there is ample ventilation (at least 10cm clearance all round). Do not put any objects on top of this unit. Do not situate it on a rug or other soft surface and do not obstruct any air inlets or outlet grilles. Do not cover the ventilation grilles with items such as newspapers, tablecloths, curtains, etc.

This unit must not be used near water or exposed to dripping or splashing water or other liquids. No objects filled with liquid, such as vases, shall be placed on the unit.



The lightning flash with the arrowhead symbol within an equilateral triangle is intended to alert the user to the presence of un-insulated 'dangerous voltage' within the product's enclosure that may be of sufficient magnitude to constitute a risk of electric shock to persons.

The exclamation point within an equilateral triangle is intended to alert the user to the presence of important operating and maintenance instructions in the service literature relevant to this appliance.



The symbol on this product indicates that it is of CLASS II (double insulated) construction.



WEEE symbol

The crossed-out wheeled bin is the European Union symbol for indicating separate collection for electrical and electronic equipment. This product contains electrical and electronic equipment which should be reused, recycled or recovered and should not be disposed of with unsorted regular waste. Please return the unit or contact the authorised dealer from whom you purchased this product for more information.



CE mark

This product complies with European Low Voltage (2006/95/EC) and Electromagnetic Compatibility (2004/108/EC) Directives when used and installed according to this instruction manual. For continued compliance only Cambridge Audio accessories should be used with this product and servicing must be referred to qualified service personnel.



C-Tick mark

This product meets the Australian Communications Authority's Radio communications and EMC requirements.



Ross Test Stamp

This product meets Russian electronic safety approvals.

FCC regulations

NOTE: THE MANUFACTURER IS NOT RESPONSIBLE FOR ANY RADIO OR TV INTERFERENCE CAUSED BY UNAUTHORIZED MODIFICATIONS TO THIS EQUIPMENT. SUCH MODIFICATIONS COULD VOID THE USER AUTHORITY TO OPERATE THE EQUIPMENT.



This equipment has been tested and found to comply with the limits for a Class B digital device, pursuant to Part 15 of the FCC Rules. These limits are designed to provide reasonable protection against harmful interference in a residential installation. This equipment generates, uses and can radiate radio frequency energy and, if not installed and used in accordance with the instructions, may cause harmful interference to radio communications. However, there is no guarantee that interference will not occur in a particular installation.

If this equipment does cause harmful interference to radio or television reception, which can be determined by turning the equipment off and on, the user is encouraged to try to correct the interference by one or more of the following measures:

- Re-orient or relocate the receiving antenna.
- Increase the separation between the equipment and receiver.
- Connect the equipment into an outlet on a circuit different from that to which the receiver is connected.
- Consult the dealer or an experienced radio/TV technician for help.

Important safety instructions (continued)

Ventilation

IMPORTANT - The unit will become hot when in use. Do not stack multiple units on top of each other. Do not place in an enclosed area such as a bookcase or in a cabinet without sufficient ventilation.

Ensure that small objects do not fall through any ventilation grille. If this happens, switch off immediately, disconnect from the mains supply and contact your dealer for advice.

Positioning

Choose the installation location carefully. Avoid placing it in direct sunlight or close to a source of heat. No naked flame sources, such as lighted candles, should be placed on the unit. Also avoid locations subject to vibration and excessive dust, cold or moisture. The unit can be used in a moderate climate.

This unit must be installed on a sturdy, level surface. Do not place in a sealed area such as a bookcase or in a cabinet. Any space open at the back (such as a dedicated equipment rack) is fine however. Do not place the unit on an unstable surface or shelf. The unit may fall, causing serious injury to a child or adult as well as serious damage to the product. Do not place other equipment on top of the unit.

Due to stray magnetic fields turntables or CRT TVs should not be located nearby due to possible interference.

Electronic audio components have a running in period of around a week (if used several hours per day). This will allow the new components to settle down, the sonic properties will improve over this time.

Power sources

The unit should be operated only from the type of power source indicated on the marking label. If you are not sure of the type of power-supply to your home, consult your product dealer or local power company.

This unit has been designed to be left in standby mode when not in use as this will increase the life of the unit (this is true with all electronic equipment). To turn the unit off, switch off at the rear panel. If you do not intend to use this unit for a long period of time, unplug it from the mains socket.

Overloading

Do not overload wall outlets or extension cords as this can result in a risk of fire or electric shock. Overloaded AC outlets, extension cords, frayed power cords, damaged or cracked wire insulation, and broken plugs are dangerous. They may result in a shock or fire hazard.

Be sure to insert each power cord securely. To prevent hum and noise, do not bundle the interconnect leads with the power cord or speaker leads.

Cleaning

To clean the unit, wipe its case with a dry, lint-free cloth. Do not use any cleaning fluids containing alcohol, ammonia or abrasives. Do not spray an aerosol at or near the unit.

Battery disposal

Batteries may contain substances harmful to the environment. Please dispose of any discharged batteries with due consideration and in accordance with local environmental/electronic recycling guidelines.

Loudspeakers

Before making any connections to loudspeakers, make sure all power is turned off and only use suitable interconnects.

Servicing

These units are not user serviceable, never attempt to repair, disassemble or reconstruct the unit if there seems to be a problem. A serious electric shock could result if this precautionary measure is ignored. In the event of a problem or failure, please contact your dealer.

Limited warranty

Cambridge Audio warrants this product to be free from defects in materials and workmanship (subject to the terms set forth below). Cambridge Audio will repair or replace (at Cambridge Audio's option) this product or any defective parts in this product. Warranty periods may vary from country to country. If in doubt consult your dealer and ensure that you retain proof of purchase.

To obtain warranty service, please contact the Cambridge Audio authorised dealer from which you purchased this product. If your dealer is not equipped to perform the repair of your Cambridge Audio product, it can be returned by your dealer to Cambridge Audio or an authorised Cambridge Audio service agent. You will need to ship this product in either its original packaging or packaging affording an equal degree of protection.

Proof of purchase in the form of a bill of sale or receipted invoice, which is evidence that this product is within the warranty period, must be presented to obtain warranty service.

This Warranty is invalid if (a) the factory-applied serial number has been altered or removed from this product or (b) this product was not purchased from a Cambridge Audio authorised dealer. You may call Cambridge Audio or your local country Cambridge Audio distributor to confirm that you have an unaltered serial number and/or you purchased from a Cambridge Audio authorised dealer.

This Warranty does not cover cosmetic damage or damage due to acts of God, accident, misuse, abuse, negligence, commercial use, or modification of, or to any part of, the product. This Warranty does not cover damage due to improper operation, maintenance or installation, or attempted repair by anyone other than Cambridge Audio or a Cambridge Audio dealer, or authorised service agent which is authorised to do Cambridge Audio warranty work. Any unauthorised repairs will void this Warranty. This Warranty does not cover products sold AS IS or WITH ALL FAULTS.

REPAIRS OR REPLACEMENTS AS PROVIDED UNDER THIS WARRANTY ARE THE EXCLUSIVE REMEDY OF THE CONSUMER. CAMBRIDGE AUDIO SHALL NOT BE LIABLE FOR ANY INCIDENTAL OR CONSEQUENTIAL DAMAGES FOR BREACH OF ANY EXPRESS OR IMPLIED WARRANTY IN THIS PRODUCT. EXCEPT TO THE EXTENT PROHIBITED BY LAW, THIS WARRANTY IS EXCLUSIVE AND IN LIEU OF ALL OTHER EXPRESS AND IMPLIED WARRANTIES WHATSOEVER INCLUDING, BUT NOT LIMITED TO, THE WARRANTY OF MERCHANTABILITY AND FITNESS FOR A PRACTICAL PURPOSE.

Some countries and US states do not allow the exclusion or limitation of incidental or consequential damages or implied warranties so the above exclusions may not apply to you. This Warranty gives you specific legal rights, and you may have other statutory rights, which vary from state to state or country to country.

For any service, in or out of warranty, please contact your dealer.

Plug Fitting Instructions (UK only)

The cord supplied with this appliance is factory fitted with a UK mains plug fitted with a 5 amp fuse inside. If it is necessary to change the fuse, it is important that a 5 amp one is used. If the plug needs to be changed because it is not suitable for your socket, or becomes damaged, it should be cut off and an appropriate plug fitted following the wiring instructions below. The plug must then be disposed of safely, as insertion into a mains socket is likely to cause an electrical hazard. Should it be necessary to fit a 3-pin BS mains plug to the power cord the wires should be fitted as shown in this diagram. The colours of the wires in the mains lead of this appliance may not correspond with the coloured markings identifying the terminals in your plug. Connect them as follows:

The wire which is coloured BLUE must be connected to the terminal which is marked with the letter 'N' or coloured BLACK.

The wire which is coloured BROWN must be connected to the terminal which is marked with the letter 'L' or coloured RED.

The wire which is coloured GREEN/YELLOW must be connected to the terminal which is marked with the letter 'E' or coloured GREEN.

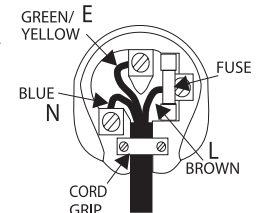

If a standard 13 amp (BS 1363) plug is used, a 5 amp fuse must be fitted, or if any other type of plug is used a 5 amp fuse must be fitted, either in the plug or adaptor, or on the distribution board.

Rear panel connections

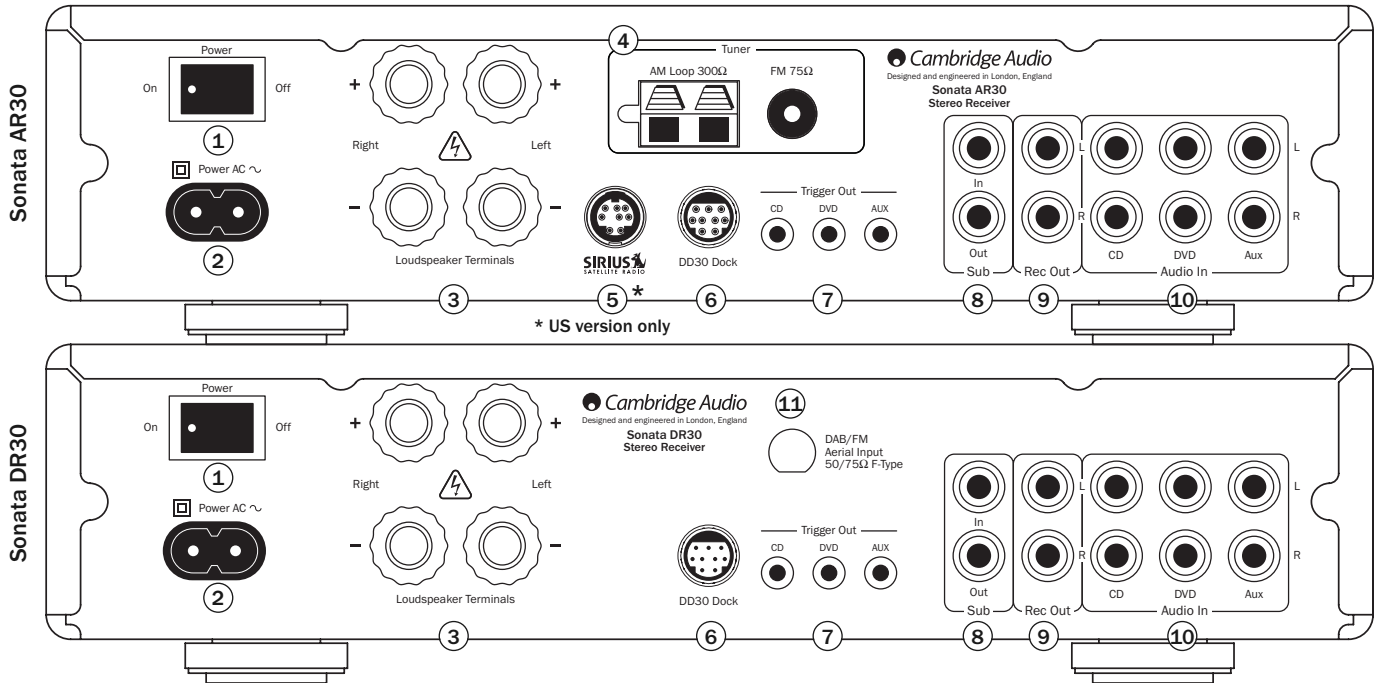

① Power On/Off

Switches the unit on or off.

② AC power socket

Once you have completed all connections to the amplifier, plug the AC power cable into an appropriate mains socket and turn the unit on. Your unit is now ready for use.

③ Loudspeaker terminals

Connect to loudspeakers with an impedance of 8ohms.

For best audio performance we recommend using speakers from Cambridge Audio's Sirocco range which have been designed in conjunction with the Sonata series. Please consult your dealer for details.

④ AM/FM antenna

Tuner aerial connections for picking up radio signals. Refer to 'Connections' section of this manual. For permanent use, outdoor AM/FM aerials are highly recommended.

⑤ SIRIUS socket (US version only)

SIRIUS satellite radio adaptor connection (requires subscription and a suitable module). Consult your dealer for more information.

⑥ DD30 dock connector

Connection for the supplied DD30 iPod dock. The docking station has a proprietary connector and will only work with the Cambridge DD30 docking station supplied.

iPod compatibility

The DD30 docking station for iPod is able to communicate with and control the following iPod models:

iPod nano (1st, 2nd, 3rd and 4th generation)
iPod (4th generation, photo and 5th generation)
iPod classic
iPod touch (1st and 2nd generation)

⑦ Trigger Out

Sonata AR30/DR30 produces trigger outputs that can be used to control the On/Standby status of other connected Cambridge Audio Sonata range source components (such as the CD30 CD player and DV30 DVD player) if desired. See 'Connections' section.

⑧ Sub In/Out

Connect Sub Out to the input of an active subwoofer. If your subwoofer has 2 inputs (i.e. left and right), then connect this terminal to the left input terminal (usually coloured white). The Sub In socket is for use with a Sonata DV30 DVD player.

⑨ Rec Out

Connect to the recording input of a tape deck, a portable music player, CD recorder input etc.

⑩ Audio Inputs

These inputs are suitable for any 'line level' source equipment such as the audio outputs of Sonata DV30 DVD player, Sonata CD30 CD player, satellite/cable receiver etc.

⑪ DAB/FM Aerial input

The Sonata DR30 has an F-type screw connection aerial for both FM and DAB signals (a temporary aerial is supplied). Extend the aerial lead and move around until you get the best reception. For permanent use, outdoor DAB and FM aerials are highly recommended.

Front panel controls

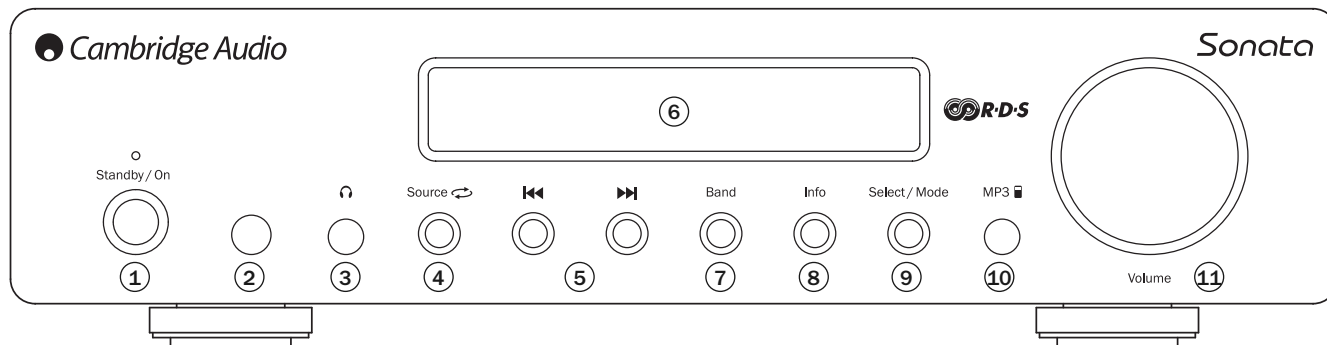

① Standby/On

Switches the unit between a low power standby mode (indicated by dim power LED) and on (indicated by bright power LED). Standby is a low power mode where the power consumption is less than 3 Watts. The unit may be left in standby mode when not in use.

② Infrared sensor

Receive IR commands from the supplied remote control. A clear unobstructed line of sight between the remote control and the sensor is required.

③ Phones

Allows for the connection of stereo headphones with a 3.5mm jack plug. Headphones with an impedance of between 32 and 600 ohms are recommended.

Note: Plugging in headphones will automatically mute the loudspeaker output.

④ Source

Press to cycle through the available input sources such as TUNER, MP3, CD, DVD and AUX inputs.

5 ⏪ ⏩ Skip/Scan

Sonata AR30

- In preset mode, steps up or down through the user-stored presets.
- In manual mode, steps through the frequency band, for fine-tuning. If button is held, the unit will search for the next station with a strong signal.

Sonata DR30

- In preset mode, steps up or down through the user-stored presets.
- In FM manual mode, steps through the frequency band, for fine-tuning. If button is held, the unit will search for the next station with a strong signal.
- In DAB manual mode, browse through the available stations.

Note:

- When MP3 input is selected, and an iPod is inserted into the attached DD30 dock, the ⏪ ⏩ buttons will skip through the track lists. Press and holding the ⏪ ⏩ buttons will scan through the current track.
- When Preset Mode is activated, the unit will automatically tune to the first available preset.

6 Display

Used to display information such as station name and program type for DAB broadcasts and FM broadcasts with RDS/RBDS. Also provides feedback on volume, source, and various other data.

7 Band

Press to switch between FM, AM and SIRIUS bands (if a SIRIUS module is attached) on AR30, or DAB and FM bands on DR30.

8 Info

Changes the display mode to allow the user to view different information. In tuner mode, data varies depending on the type of broadcast, and signal quality. When in a non-tuner mode, pressing the *Info* button will briefly display the clock time, before returning to show the current source.

9 Select/Mode

In tuner mode, pressing once will toggle the tuning mode between preset and manual. In presets mode, the unit will automatically tune to the first available preset in the band.

Alternatively, you may press and hold to store the current station in the preset bank. Use the ⏪ ⏩ keys or rotate the *Volume control* to select the preset location where you wish to store the preset, and press *Select/Mode* again to confirm.

10 MP3 Input

This source input allows you to connect a portable audio device such as an MP3 player directly into the front of the unit using the 3.5mm stereo-jack (labelled 'MP3 In'). Select the MP3 input source using the Source button or direct MP3 button on the remote to listen to your portable audio device.

Note: Plugging a source into the front panel MP3 input overrides the DD30 docking station (which is also selected by selecting the MP3 source via the remote control or front panel Source button). Simply remove the jack from the front panel socket to automatically re-enable the DD30 docking station as the MP3 source.

There is no need to unplug the DD30 docking station whilst using the front panel MP3 input and it will continue to charge a docked iPod as usual.

11 Volume control

Use to increase or decrease the level of the sound from the outputs of the unit. This controls the volume level of the loudspeakers, subwoofer and headphones. It does not affect the 'Rec Out' output.

It is also used to change the value of the selected settings in audio setup and advanced setup menus.

Press once to enter the audio setup menu. Press and hold to enter the advanced setup menu. See later section in this manual.

Remote control

The Sonata AR30 and DR30 are both supplied with a Navigator remote control that operates the units.

Standby/On

Switches the unit between Standby and On mode.

0-9 numeric buttons

Press to recall stored presets.

Numerical select

To recall a preset number greater than ten, press  followed by the required preset number.

Mute

Mutes the audio on the unit. Press again to cancel mute.

Band

AR30 – Switches the unit between FM, AM and SIRIUS (if fitted, US version only) bands.

DR30 – Switches the unit between DAB and FM bands.

Volume

Increases or decreases the volume of the unit.

It is also used to change the value of the selected menu settings in audio setup and advanced setup menus.

Navigation

In preset mode, press to step through the preset stations.

To navigate around presets, press the directional arrows up or down. If an iPod is inserted in the attached docking station and MP3 source selected, you can use the navigation keys to browse your iPod's content.

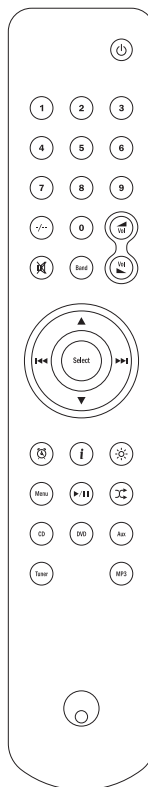

Select

Press to accept the item/function highlighted in the display menu, or while navigating your iPod.

In tuner mode, press and hold to store the current station in the preset bank.

Note: If browsing through DAB stations, press **Select** to immediately tune to the current station (DR30 only).



Skip/Scan





Sonata AR30

– In manual mode, press and hold to scan to the next or previous station. Short press once to fine-tune frequency. Refer to the 'Tuning and listening' section of this manual.

Sonata DR30

– In FM manual mode, press and hold to scan to previous or next available stations. Short press once to fine-tune frequency. Refer to the 'Tuning and listening' section of this manual.

– In DAB manual mode, you can step through the stations stored alphabetically in the DAB database. Press the  button to step through to previous stations or  to step through to the next stations. If you wish to perform a complete scan of all available stations, press and hold down the  button. Refer to the 'Tuning and listening' section of this manual.

Note: When MP3 input is selected, and an iPod (depending on the model and generation) is inserted into the attached DD30 dock, the   buttons will skip through the track lists. Press and hold the   buttons, will scan through the current track.

 **Alarm/Clock**

Press once to enter the Alarm menu. Press and hold to enter the Sleep menu. Refer to the 'Operation instructions' section of this manual.

 **Info**

Changes the display mode to allow the user to view different information. Tuner data varies depending on the type of broadcast, and signal quality. When in a non-tuner mode, pressing the **i** button will briefly display the clock time, before returning to show the current source.

 **Brightness**

Switches the display brightness between bright and dim.

Source buttons (CD, DVD, Aux, Tuner, MP3)

Press the relevant source button to select desired input source.

Menu

Press and hold to enter the audio setup menu. It is also used to cycle through the menu items in audio setup and advanced setup menus.

Also used in iPod mode, see next section.

iPod compatibility

The supplied remote can also control the basic functions of an iPod when mounted in the DD30 docking station. Refer to 'Using the supplied DD30 docking station for iPod' on how to connect your DD30 docking station.

iPod compatibility

The DD30 is able to communicate with and control the following iPod models:



iPod nano (1st, 2nd, 3rd and 4th generation)
iPod (4th generation, photo and 5th generation)
iPod classic
iPod touch (1st and 2nd generation)
iPod mini

To use the remote to control a docked iPod, press the MP3 source button then one of the following buttons:

 **Play/Pause**

Press to begin playback and press again to pause playback.

 **Skip/Scan**

Press the  button to skip to previous track or press the  button to skip to the next track. Press and hold either buttons, will scan through the current track.

Select

Press to accept the item/function highlighted on the display menu on your iPod. Pressing the button continuously during playback will cycle the progress bar to track time, scrubber and track ratings on the iPod's display. Depending on the iPod generation, additional functions will be available on the progress bar.

Menu

Press once to step back one menu on your iPod. Refer to the 'Operation instruction' section of this manual.

 **Shuffle**

Press to switch your iPod's shuffle function on and off.

Connections

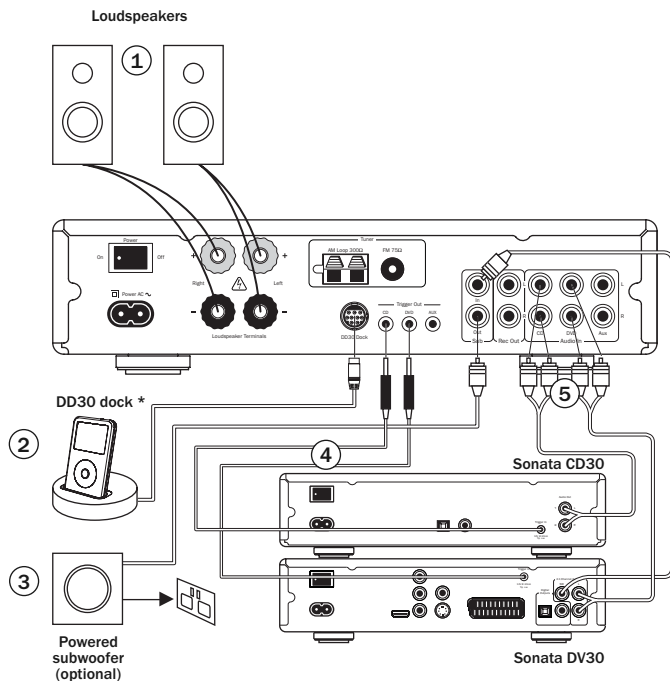

* iPod not included

Note: Do not plug in the mains power lead or turn on the unit until all connections have been made.

① Loudspeakers

Check the impedance of your speakers. Speakers with an impedance of between 4 and 8 Ohms are recommended.

The red coloured speaker terminals are positive (+) and the black speaker terminals are negative (-). Make sure correct polarity is maintained at each speaker connector or the sound can become weak and “phasey” with little bass.

Prepare the speaker cords for connection by stripping off approximately 10mm (3/8”) or less of the outer insulation. More than 10mm could cause a short circuit. Twist the wires tightly together so there are no loose ends. Unscrew the speaker terminal knob, insert the speaker cable, tighten the knob and secure the cable.



Note: All connections are made using standard loudspeaker cable. If an active subwoofer is used, connect via a standard single RCA/phono cable (often referred to as a 'Sub-Link').

② DD30 docking station

Connect the supplied DD30 docking station to the connector located at the rear.

③ Active subwoofer In/Out

Connect the output to an active subwoofer using a standard RCA/phono cable (if required). The input allows the Sonata AR30/DR30 to pass through the subwoofer output (LFE) of an attached Sonata DV30 DVD player.

4 Trigger outputs/Power syncing

Your Sonata AR30 or DR30 can automatically power on or switch into Standby, a matching Sonata CD30 CD player or DV30 DVD player. The Sonata CD30 and DV30 comes with a trigger lead for this purpose.

To enable this feature:

1. Switch off all Sonata units.
2. Connect one of the provided trigger lead between your source equipment and the corresponding trigger connection at back of the Sonata AR30 or DR30 unit (e.g. connect the Sonata AR30 or DR30 CD trigger output to the Sonata CD30 trigger input).
3. Switch all Sonata units back on.

Now, when the CD or DVD sources are selected on the Sonata AR30 or DR30, the appropriate Sonata source equipment will switch on. Conversely, when a different source is selected, the appropriate Sonata source will go into Standby, also when the Sonata AR30 or DR30 is put in standby mode, all the Sonata units will also go into Standby.

5 Audio inputs

Also available in the Sonata range are the CD30 CD player and DV30 HDMI DVD player. These can, if desired, be connected to the unit's corresponding CD and DVD inputs using good quality stereo RCA/Phono leads (not supplied) as shown.

Aerials

Note: Sonata AR30 and DR30 are supplied with a temporary aerial for initial use. For permanent use, outdoor aerials are highly recommended.

AM loop aerial

Connect each end of the single length antenna to the antenna terminals. Place the antenna as far from the main system as possible to prevent unwanted noise and to obtain optimum reception. If the AM loop aerial provided does not receive sufficient reception, it may be necessary to use an outdoor AM aerial.

FM aerial

Connect the supplied aerial to the FM 75 ohm socket. Extend and move the aerial lead around until you get the best reception. For continued use, we strongly recommend using a 75ohm outdoor FM aerial.

SIRIUS ready (US version only)

The SIRIUS socket allows the connection of a SIRIUS satellite radio reception module (require subscription). Consult your dealer for more information.

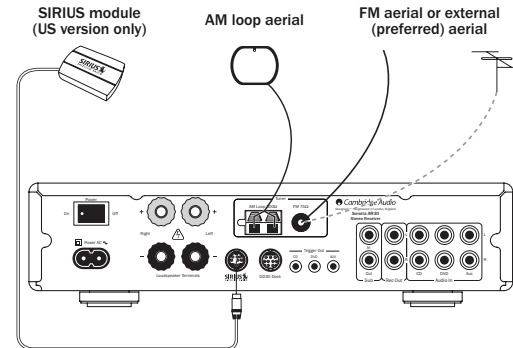

Aerials (continued)

DAB aerial

The Sonata DR30 has an F-type screw connection aerial for both FM and DAB signals. Connect the supplied combined DAB/FM aerial to the socket. For continued use, we strongly recommend an external aerial. This should be a combined DAB/FM type or separate aerials diplexed onto a single co-axial cable run.

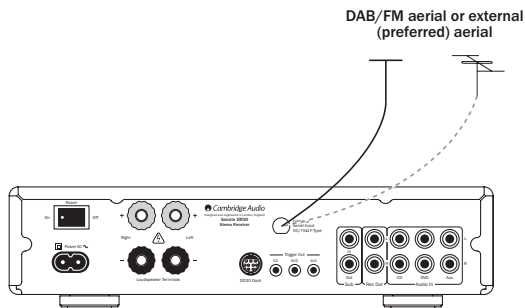

Operating instructions

After making the connections to your unit, activate the Sonata AR30/DR30 by switching the power button on the rear panel to 'On', then press the Standby/On button on the front of the unit or remote.

Changing DAB region (DR30 only)

The DR30 has been pre-configured with a DAB region 'EUROPE' as the default setting. However, the DAB can be set to a different region depending on your location. To change the current DAB region, do the following:

Note: Make sure that the unit is turned off from the back Power switch.

1. Hold the Band button while powering the unit up. The DAB current region will be displayed when the unit powered up.
2. Pressing the Band button will toggle between CANADA, KOREA, EUROPE.
3. Choose the correct DAB region by pressing the Select/Mode button. The unit will then go to Standby mode and ready to be used.

Note: Always perform a complete DAB station scan every time a new DAB region has been selected. For more information on complete DAB station scanning, see later section 'Tuning/Listening'.

Setting the source

Press the *Source* button on the front of the unit until the display indicates that the required input is selected. Alternatively, you may select the desired input directly by pressing the appropriate button on the remote control.



Adjusting the volume

Use either the *Volume Up/Down* buttons on the remote control, or the *Volume control* on the front of your Sonata system to change the volume level. The newly selected level will be indicated briefly on the front display.

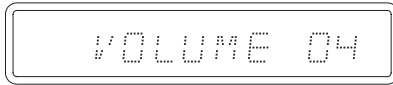

Adjusting the audio settings

Adjustments to the bass, treble, balance and sub level can be made as follows:

1. To enter the audio menu. Briefly press either the *Volume control* on the front of the unit or **press and hold** the *Menu* button on the remote control.

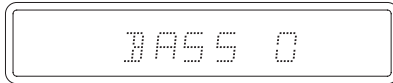

2. Step through the available settings by either pressing the *Volume control* or the *Menu* button on the remote. Adjustments for bass, treble, balance and sub level are possible.
3. When you wish to make an adjustment, simply rotate the *Volume control* or use the *Volume control* buttons on the remote control.

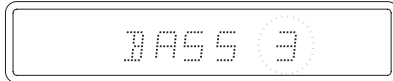

4. To exit, press the *Select* button or wait for five seconds, until the unit returns to normal mode.

The sub level control adjust the relative level of the subwoofer output and main stereo outputs and can be used to control the sub level for late night listening etc.

Tuning and listening

Select the Tuner source using the *Source* button on the front of the unit or direct *Tuner* button on the remote.

Note: Before tuning your Sonata AR30/DR30, make sure that the stereo receiver is set to 'Manual mode'. Press the *Select/Mode* button on the front of the unit to select the correct mode.

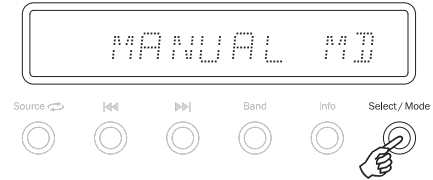

Sonata AR30

1. In tuner mode press the *Band* button to toggle between AM/FM modes (and SIRIUS if an optional SIRIUS-Ready module is attached, US version only).
2. Press and hold the **⏮** button to scan to previous available stations or press and hold the **⏭** button to scan to the next available stations. 'SCANNING' will be displayed while scanning for available stations as shown below.



3. Short press once the **⏮** or **⏭** button to fine-tune station frequency.

Operating instructions (continued)

Sonata DR30

1. In tuner mode press the *Band* button to toggle between DAB/FM modes.
2. In FM mode, press and hold the **⏮** button to scan to previous available stations or press and hold the **⏭** button to scan to the next available stations. 'SCANNING' will be displayed while scanning for available station as shown previously. Briefly press the **⏮** or **⏭** button to fine-tune the station frequency.
3. To perform a complete scan of the DAB broadcasting band, press and hold the **⏭** button to enter the scan menu. Rotate the *Volume control* or press the volume control on the remote to select 'Yes'. Press the *Volume control* or *Select* on the remote to confirm and proceed with the scan.



Note: In some regions, the complete scan process can take up to three minutes to complete.

4. In DAB mode, press the **⏮** or **⏭** button to browse through the stations currently stored in the tuner's database. To select a station, either press *Select* on the remote control, or *Select/Mode* on the front of the unit. Alternatively, the currently viewed station will be selected automatically if no button is pressed for five seconds.

Setting presets

Radio stations can be stored into the memory presets for easy access. You can store up to 20 presets for each band (for example, 20 presets for the AM band plus 20 presets for the FM band and 20 presets for the DAB band).

1. Select the station you wish to store and hold down the *Select* button. The display on the unit shows the next available preset.



2. Rotate the *Volume control* on the front of the unit or press the volume control on the remote to move to a new preset number and press *Select* to store the preset. The display will briefly show that the station has been stored.



3. To load a stored preset, simply press the number on the remote control that corresponds with the preset you wish to access. Use **-/-** on the remote when loading stored presets greater than 9.

Note: Stored presets can be replaced by saving a new desired station into any preset.

Setting the clock

By default, the clock will set itself according to the clock data transmitted by SIRIUS, DAB or RDS enabled FM broadcasts. If you are not in a region where you can receive these transmissions, you can set the clock manually.

To set the clock time:

1. Press and hold the *Volume control* on the front of the unit to enter the advanced settings menu.
2. Cycle through the different settings by pressing the *Volume control* or pressing the volume control on the remote.
3. When 'Clock Aut' is displayed, rotate the *Volume control* or the volume control on the remote to change the setting to 'Clock Man'. Press the *Volume control* or the volume control on the remote to confirm your choice.

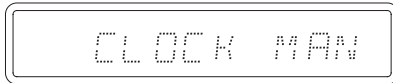

4. Change the hour by rotating the *Volume control* or pressing the volume control on the remote. Press the *Volume control* or the *Menu* button on the remote to confirm, and proceed to adjust the minutes in the same manner.

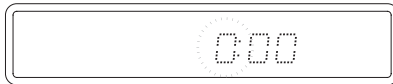

5. When you have finished setting the time, press the *Volume control* or the *Menu* button on the remote to return the unit to normal operation.

Setting the time zone (US version only)

If the Sonata AR30 is configured for automatic time-set, and the unit is connected to a SIRIUS tuner module, it is important to specify the appropriate time-zone for your geographic region.

To set the time zone:

1. Enter the advanced settings menu and select 'Clock Aut', refer to previous section 'Setting the clock'.

The unit will display the current time zone. See below for the appropriate time zone:

Zone NST = GMT-3h30 (Newfoundland)

Zone AST = GMT-4h (Atlantic)

Zone EST = GMT-5h (Eastern)

Zone CST = GMT-6h (Central)

Zone MST = GMT-7h (Mountain)

Zone PST = GMT-8h (Pacific)

Zone AKST = GMT-9h (Alaska)

2. Rotate the *Volume control* on the front of the unit until your desired time zone is displayed. Press the *Volume control* to confirm.

Please continue to set the Daylight Saving Time to either 'DST On' or 'DST Off'. If set to 'On', then USA/Mexico/Canada daylight saving will be observed.

3. When you have finished setting the time zone, press the *Volume control* to return the unit to normal operation.

Operating instructions (continued)

Setting the alarm

The alarm function can turn on the unit at a chosen time. When the alarm activates it will either select the MP3 source and play your iPod, or select the tuner band of your choice and preset 1 in that band.

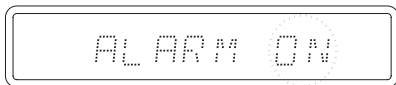

To set the alarm time:

1. Press the  button on your remote control. The unit will display either 'Alarm On' or 'Alarm Off'. Turn the *Volume control* or press the volume control on the remote to change the mode if necessary.

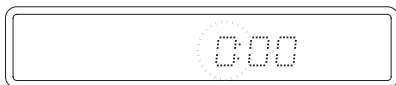

2. Press the  button to accept and progress to set the hour.
3. Turn the *Volume control* or press the volume control on the remote to alter the hour.



4. Press the  button to accept and progress to set the minutes.
5. Turn the *Volume control* or press the volume control on the remote button to alter the minutes.
6. Press the  button to confirm the alarm time.
7. The unit will display the source it will automatically select when the alarm is activated. For example, the Sonata DR30 will either display 'Wake MP3', 'Wake DAB' or 'Wake FM'. Turn the *Volume control* or press the volume control on the remote button to select your desired wake-up source.



8. Press the  button to finish setting the alarm. 'Alarm set' will be displayed briefly before the unit goes to standby mode.

Note: Preset 1 in the selected band will always be used, so make sure this is your favourite early morning station.

Setting the sleep time

The sleep function will turn off the unit after a chosen time period has elapsed. It will also generate a command on the trigger output which can, switch off any appropriately connected Sonata source equipment.

To set the sleep time:

1. Press and hold the  button on your remote control. The unit will display either 'Sleep On' or 'Sleep Off'. Rotate the *Volume control* or press the volume control on the remote to change the mode.

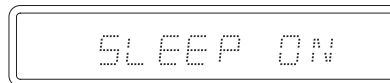

2. Press the  button to accept and advance to sleep countdown time.
3. The period of time before the unit switches off is displayed. Rotate the *Volume control* or press the volume control on the remote to adjust the time.

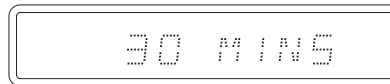

4. Press the  button to confirm the sleep time. 'Sleep set' will be displayed briefly before the unit goes back to normal mode.

Note: Selectable time intervals for the sleep function are 15, 30, 45 and 60mins, then it will be 30mins intervals thereafter with 12hrs being the maximum elapsed time. The sleep function will always reset after it has been performed.

Advanced settings

The advanced settings menu allows you to adjust the input gain for the Aux and MP3 external sources, set the clock, and assign a custom name to the Aux input.

Note: The advanced settings menu can only be accessed by pressing and holding the Volume control on the front of the unit. It is not possible to access the advanced settings menu using the Sonata remote.

To adjust the input trim or gain (if the Aux or MP3 source is too quiet compared to other sources):

1. Press and hold the *Volume control* to enter the advanced settings menu. The first item shown is the gain trim for the Auxiliary input as shown.

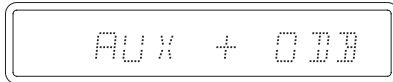

2. Navigate through the menu by pressing the *Volume control* again or the *Menu* button on the remote until it displays the input gain for MP3 or Aux sources.

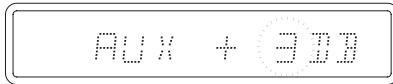

3. To adjust the gain, simply rotate the *Volume control* or use the *volume control* on the remote. To confirm your choice, press the *Volume control* or the *Menu* button on the remote.
4. To exit advanced settings, repeatedly press the *Volume control* or the *Menu* button on the remote until a source is displayed. Alternatively, you can press *Select/Mode* on the front of the unit to exit at any time.

Note: If nothing is pressed after five seconds, the unit goes back to normal mode.

To re-name the Aux input

The aux input can be renamed thereby allowing you to more easily identify the connected source equipment. The name can be up to five characters long.

1. Press and hold the *Volume control* on the front of the unit to enter the advanced settings menu.
2. Press the *Volume control* or press the *Menu* button on the remote, scrolling through the advanced settings menus until 'Aux Norm' is displayed.
3. Rotate the *Volume control* or press the volume control buttons on the remote control so it now shows 'Aux Cust'.



4. Press the *Volume control* or the *Menu* button on the remote control to confirm your choice.
5. Rotate the *Volume control* or press the volume control on the remote to cycle through the available characters. When you have identified the correct character, press the *Volume control* or the *Menu* button on the remote control to move the cursor along one space.

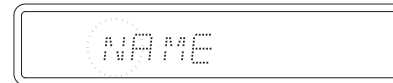

6. Repeat as above until all five characters are used. Insert spaces if the name is less than five characters long.
7. Press the *Volume control* or the *Menu* button on the remote control to complete the naming process.

Note: If nothing is pressed for five seconds, the unit will revert back to normal mode. To continue, repeat the above steps.

Operating instructions (continued)

Using the supplied DD30 docking station for iPod

Note: Make sure that there's no device attached to the MP3 input on the front of the unit for the DD30 docking station to work.

The Sonata AR30/DR30 comes with a supplied DD30 docking station for iPod. Connect the DD30 to the connector located on the back of the unit and insert an appropriate iPod dock adaptor for your iPod. DD30 docking station is compatible with Apple's standard dock adaptors, supplied with all new iPod.

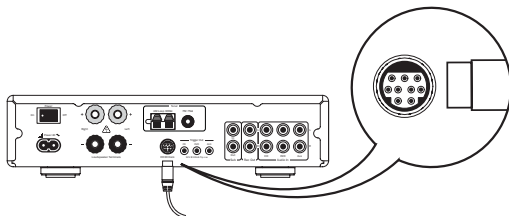

1. Switch the unit on, and select the MP3 input source by pressing the *Source* button or the source buttons on the remote.



2. Press the *Play/Pause* button to start playback.
3. Press the *Menu* button to step back one menu on your iPod.
4. Use the navigator \blacktriangle \blacktriangledown buttons on your remote to browse through the menu.
5. Press the *Select* button on the remote to choose a menu item.
6. Press the \ll or \gg button will skip through the track lists. Press and hold \ll or \gg button to scan through the current track.

Note: Press and hold the *Play/Pause* button to switch off the iPod.

Refer to 'Remote control' section of this manual for controlling your iPod using the supplied remote control.

iPod compatibility

The DD30 is able to communicate with and control the following iPod models:

- iPod nano (1st, 2nd, 3rd and 4th generation)
- iPod (4th generation, photo and 5th generation)
- iPod classic
- iPod touch (1st and 2nd generation)
- iPod mini

Note: The DD30 dock station also charges your iPod when docked even when the unit is in standby mode. This function will not work if the 'Power' on the back of the unit is turned off.

Connecting and using a SIRIUS Connect Home Tuner (US version only)

The Sonata AR30 can be used in conjunction with a compatible SIRIUS receiver module such as the SIRIUS Connect Home Tuner SC-H1. This module allows you to subscribe and listen to any station on the SIRIUS satellite radio network.

Please carefully read the instructions included with your particular tuner, paying attention to antenna configuration.

Note: The supplied AC power adaptor should be used, since the unit cannot power the SIRIUS tuner module.

Ensure your Sonata AR30 is powered Off using the switch on the rear panel. Connect the SIRIUS module using the supplied DIN cable. Connect the AC power supply to the Home Tuner, and confirm that the LED indicator is on.

Power on your Sonata AR30 from the rear panel.

Subscribing to SIRIUS services

First, make a note of your Home Tuner's identification number (SID). This number may be obtained by selecting SIRIUS mode, and holding down the *Info* button on the front of the unit. The SID may also be found on a label located on the Home Tuner module.

To activate your subscription, please call 1-888-539-SIRIUS (1-888-539-7474).

Alternatively, visit www.sirius.com and click Activate. Follow the instructions to register your module.

Positioning the antenna

The antenna must be positioned in such a way that the tuner can receive the best possible signal from the transmission satellite. The direction of the antenna depends on your geographical location in the United States.

Location

Northwestern US or western Canada
Midwestern US or central Canada
Northeastern US or eastern Canada
Southwestern US
South central US
Southeastern US

Antenna Direction

East
Directly above
West
North-east
North
Northwest

The LED indicator on the receiver module will turn green when you have sufficient signal strength.

Manual Tuning

In this mode, you can navigate through all subscribed stations using the **◀ ▶** buttons on the front of the unit and remote control.

1. Press the *Source* button until SIRIUS is displayed.
2. Use the **◀ ▶** buttons on either the remote control or front of the unit to browse through available stations. If the station you wish to listen to is not present, you may need to add it to your subscription. Call 1-888-539-SIRIUS for more information.
3. To store a station as a preset, hold down the *Select/Mode* button on the front of the unit, or the *Select* button on your remote control.
4. You may rapidly step through the subscribed and available channels by holding down either the **◀** or **▶** buttons on the front of the unit and remote control.

Direct Tuning

You can tune directly to a channel of your choice by briefly pressing the *Select* button on the remote control. The display will show 'CHAN ---'. Enter the channel number you wish to tune to using the numeric buttons on the remote.

Category Tuning

This allows you to browse and select a category using the **▲ ▼** buttons on the remote control.

1. Press *Select/Store* button on the front of the unit. When the display reads 'CAT MODE', you are successfully in category tuning Mode.
2. Browse through the available categories by using the **▲ ▼** buttons.
3. Press the **◀ ▶** buttons to browse through the available stations within the chosen category. If the station you wish to listen to isn't present, you may need to add it to your subscription. Call 1-888-539-SIRIUS for more information.
4. If you wish to exit category mode (and allow the **▲ ▼** buttons to browse presets) simply press the *Select/Mode* button.

Factory reset

To clear all presets, and restore all settings to the factory defaults:

1. Turn off the unit from the main power switch at the back.
2. Hold down the *Select/Mode* button on the front of the unit.



3. Switch on from the main power switch at the back of the unit, while continuing to hold the *Select/Mode* button on the front of the unit.
4. The display will show the text 'Reset' and the unit will power off.



Troubleshooting

There is no power

Ensure the AC power cord is connected securely.

Ensure the plug is fully inserted into the wall socket and is switched on.

Check fuse in the mains plug or adaptor.

Check the power switch is on at the back of the unit.

There is no sound

Ensure that the unit is set correctly.

Check that the speakers are connected correctly.

Check aerial connections and an available station is selected.

If using the DD30 dock make sure nothing is connected to the MP3 input on the front of the unit.

Check the unit is not in mute mode.

The sound is distorted

Check aerial connections and placements.

Check speaker connections.

Check the iPod is inserted fully.

There is a hum coming from the speaker

Ensure that all cable connections are secure, particularly ground/shield connections.

There is unwanted background noise and interference

Move the unit away from other electrical equipment that is likely to cause interference.

Re-orientate the aerial

The remote handset will not function

Check that the batteries have not expired.

Ensure that nothing is blocking the remote sensor.

Technical specifications

AR30/DR30 specifications

Amplifier section

Power output	40 watts per channel (into 8Ω)
THD	<0.05% 20Hz-20kHz @ 80% max power <0.009% @ 1kHz 10w
Frequency response	10Hz - 50kHz +/-1dB
S/N ratio (ref 1w)	>80dB 'A' weighted
Line input impedances	47kohms (CD, DVD, Aux and MP3 inputs)
Tone controls	+/-12dB @ 100Hz and 10kHz (shelving)
Headphone output	3.5mm stereo mini jack 32-600ohm headphones recommended

Tuners

Bands	AR30 US: AM (530-1710kHz) US: FM/VHF (88MHz to 108MHz) EU: AM (531-1620kHz) EU: FM/VHF (87.5MHz to 108MHz)
	DR30 US: FM/VHF (88MHz to 108MHz) EU: FM/VHF (87.5MHz to 108MHz) DAB Band 3 (175MHz to 240MHz) DAB L Band (1453MHz to 1491MHz)
Aerial inputs	AR30 FM 75ohms, Coaxial. AM 300 ohms wire loop/single wire.
	DR30 Combined FM/DAB: 50-75 ohms, F-Type.
Signal to noise	80dB typical (DAB) 60dB typical (FM)

Distortion	<0.01% @1kHz 2V rms o/p (DAB) <0.2% @ 1kHz 50kHz deviation (FM mono) <0.6% @ 1kHz 50kHz deviation (FM stereo)
------------	---

DD30 docking station for iPod

THD	<0.009% @ 1kHz
S/N ratio	<-80dB re 2V output.

General

Trigger Outputs	3 x 3.5mm jack, Tip positive. Corresponding to CD, DVD and Aux inputs
Power Supply	DR30-EU: 230V AC~ 50Hz (UK/EU/AU) DR30-CU: 115V AC~ 60Hz (CU/US) AR30-EU: 230V AC~ 50Hz (UK/EU) AR30-CU: 115V AC~ 60Hz (CU/US)
Max. power consumption	300W
Standby power consumption	<3W
Dimensions	270 x 67 x 285mm (WxHxD)
Weight	4.0kg (8.6lbs)

Cambridge Audio is a brand of Audio Partnership Plc
Registered Office: Gallery Court, Hankey Place,
London SE1 4BB, United Kingdom
Registered in England No. 2953313

www.cambridge-audio.com



© 2009 Cambridge Audio Ltd