

 **CAMBRIDGE**

CXR120/200

AV RECEIVER



**GREAT BRITISH
SOUND** SINCE 1968

Contents

Important safety instructions	3
Limited warranty	4
Front panel controls	5
Rear panel connections.....	5
Main remote control	6
Loudspeaker connections.....	7
Analogue audio connections.....	7
Digital audio connections.....	8
5.1/7.1 direct in	8
HDMI connections.....	9
4K video resolution.....	9
Aerial connections.....	10
Using the tuner	10
Presets	10
StreamMagic	10
Operating instructions.....	10
Selecting the source.....	10
Selecting the desired listening mode	10
Surround sound modes.....	10
DSP modes	11
Stereo/Stereo + Sub.....	11
Direct.....	11
All channels	11
Setup menu	12
Speaker setup	12
Speaker configuration	12
Auto Setup	12
Manual Setup	13
Input Setup.....	13
Lip sync.....	14
Zone 2 (CXR200 only).....	14
Network Setup.....	14
Connecting to a wired network	14
Network Setup.....	14
Wireless Setup	14
General Settings.....	15
HDMI Output Setup.....	15
DTS-HD speaker re-map.....	16
Trigger outputs	16
SW Version	16
Update Via USB	16
Save Current Settings	16
Load Current Settings	16
Factory Reset	16
Network software update	16
Web administration interface.....	16
Wired connection	16
Wireless connection	16

Before connecting

The process of setting up the CXR is first to make all the connections to your speakers and source equipment and then set the unit up via its On-Screen Display (OSD). There are various settings and adjustments that need to be made before the CXR can be used.

However before you actually decide which connections to make or perform any adjustments it is strongly advised that you read through the 'Setup menu' section of this manual first, starting on page 12.

For more detailed information, please visit our website www.cambridgeaudio.com for the product reference manual and FAQ.

Make sure you register your purchase.

Visit: www.cambridgeaudio.com/vip

By registering, you'll be the first to know about:

- **Future product releases**
- **Software upgrades**
- **News, events and exclusive offers plus competitions!**

This guide is designed to make installing and using this product as easy as possible. Information in this document has been carefully checked for accuracy at the time of printing; however, Cambridge Audio's policy is one of continuous improvement, therefore design and specifications are subject to change without prior notice.

© Copyright Cambridge Audio Ltd 2016.

For DTS patents, see <http://patents.dts.com>. Manufactured under license from DTS Licensing Limited. DTS, DTS-HD, the Symbol, & DTS and the Symbol together are registered trademarks, and DTS-HD Master Audio is a trademark of DTS, Inc. © DTS, Inc. All Rights Reserved.

Manufactured under license from Dolby Laboratories. Dolby, Pro Logic, and the double-D symbol are trademarks of Dolby Laboratories.

"HDMI", "HDMI logo" and "High-Definition Multimedia Interface" are trademarks or registered trademarks of HDMI Licensing LLC.

The Spotify software is subject to third party licenses found here: www.spotify.com/connect/third-party-licenses.

Important safety instructions

For your own safety please read the following important safety instructions carefully before attempting to connect this unit to the mains power supply. They will also enable you to get the best performance from and prolong the life of the unit:

1. Read these instructions.
2. Keep these instructions.
3. Heed all warnings.
4. Follow all instructions.
5. Do not use this apparatus near water.
6. Clean only with a dry cloth.
7. Do not block any ventilation openings. Install in accordance with the manufacturer's instructions.
8. Do not install near any heat sources such as radiators, heat registers, stoves, or other apparatus (including amplifiers) that produce heat.
9. Do not defeat the safety purpose of the polarized or grounding-type plug. A polarized plug has two blades with one wider than the other. A grounding-type plug has two blades and a third grounding prong. The wide blade or the third prong are provided for your safety. If the provided plug does not fit into your outlet, consult an electrician for replacement of the obsolete outlet.
10. Protect the power cord from being walked on or pinched, particularly at plugs, convenience receptacles and the point where they exit from the apparatus.
11. Only use attachments/accessories specified by the manufacturer.
12. Unplug this apparatus during lightning storms or when unused for long periods of time.
13. Refer all servicing to qualified service personnel. Servicing is required when the apparatus has been damaged in any way, such as the power-supply cord or plug having been damaged, liquid has been spilled or objects have fallen into the apparatus, the apparatus has been exposed to rain or moisture, does not operate normally, or has been dropped.

WARNING: TO REDUCE THE RISK OF FIRE OR ELECTRIC SHOCK, DO NOT EXPOSE THIS APPARATUS TO RAIN OR MOISTURE AND OBJECTS FILLED WITH LIQUIDS, SUCH AS VASES, SHOULD NOT BE PLACED ON THIS APPARATUS.

Batteries (battery pack or batteries installed) shall not be exposed to excessive heat such as sunshine, fire or the like.

TO COMPLETELY DISCONNECT THIS APPARATUS FROM THE AC MAINS, DISCONNECT THE POWER SUPPLY CORD PLUG FROM THE AC RECEPTACLE. POUR DECONNECTER COMPLETEMENT L'APPAREIL DU RESEAU D'ALIMENTATION, DECONNECTER LE CORDON D'ALIMENTATION DE LA PRISE MURALE.

THE MAINS PLUG OF THE POWER SUPPLY CORD SHALL REMAIN READILY ACCESSIBLE. LA PRISE DU RESEAU D'ALIMENTATION DOIT DEMEURER AISEMENT ACCESSIBLE"

Only use the mains cord supplied with this unit.





The lightning flash with the arrowhead symbol within an equilateral triangle is intended to alert the user to the presence of un-insulated 'dangerous voltage' within the product's enclosure that may be of sufficient magnitude to constitute a risk of electric shock to persons.

The exclamation point within an equilateral triangle is intended to alert the user to the presence of important operating and maintenance instructions in the service literature relevant to this appliance.

 The symbol on this product indicates that it is of CLASS II (double insulated) construction.

 **WEEE symbol**
The crossed-out wheeled bin is the European Union symbol for indicating separate collection for electrical and electronic equipment. This product contains electrical and electronic equipment which should be reused, recycled or recovered and should not be disposed of with unsorted regular waste. Please return the unit or contact the authorised dealer from whom you purchased this product for more information.

 **CE mark**
This product complies with European Low Voltage (2014/35/EU), Electromagnetic Compatibility (2014/30/EU) and Environmentally-friendly design of Energy-related Products (2009/125/EC) Directives when used and installed according to this instruction manual. For continued compliance only Cambridge Audio accessories should be used with this product and servicing must be referred to qualified service personnel.

 **RCM (Regulatory Compliance Mark)**
This product meets the Safety, EMC and Radio Communications requirements of the ERAC and ACMA.

 **CU-TR Mark**
This product meets Russia, Byelorussia and Kazakhstan electronic safety approvals.

 **Caution: Hot Surface. Do Not Touch**
The top surface over the internal heat sink may become hot when operating this product continuously. Do not touch hot areas, especially around the "Hot surface mark" and the top panel.

FCC regulations
NOTE: THE MANUFACTURER IS NOT RESPONSIBLE FOR ANY RADIO OR TV INTERFERENCE CAUSED BY UNAUTHORIZED MODIFICATIONS TO THIS EQUIPMENT. SUCH MODIFICATIONS COULD VOID THE USER AUTHORITY TO OPERATE THE EQUIPMENT.

 This equipment has been tested and found to comply with the limits for a Class B digital device, pursuant to Part 15 of the FCC Rules. These limits are designed to provide reasonable protection against harmful interference in a residential installation. This equipment generates, uses and can radiate radio frequency energy and, if not installed and used in accordance with the instructions, may cause harmful interference to radio communications. However, there is no guarantee that interference will not occur in a particular installation.

If this equipment does cause harmful interference to radio or television reception, which can be determined by turning the equipment off and on, the user is encouraged to try to correct the interference by one or more of the following measures:

- Re-orient or relocate the receiving antenna.
- Increase the separation between the equipment and receiver.
- Connect the equipment into an outlet on a circuit different from that to which the receiver is connected.
- Consult the dealer or an experienced radio/TV technician for help.

Ventilation

IMPORTANT – The unit will become hot when in use. Do not stack multiple units on top of each other. Do not place in an enclosed area such as a bookcase or in a cabinet without sufficient ventilation.

Ensure that small objects do not fall through any ventilation grille. If this happens, switch off immediately, disconnect from the mains supply and contact your dealer for advice.

Please ensure there is ample ventilation (at least 20cm clearance on the top, side and rear). Do not put any objects on top of this unit. Do not situate it on a rug or other soft surface and do not obstruct any air inlets or outlet grilles. Do not cover the ventilation grilles with items such as newspapers, tablecloths, curtains, etc.

Positioning

Choose the installation location carefully. Avoid placing it in direct sunlight or close to a source of heat. No naked flame sources, such as lighted candles, should be placed on the unit. Also avoid locations subject to vibration and excessive dust, cold or moisture. The unit can be used in a moderate climate.

This unit must be installed on a sturdy, level surface. Do not place in a sealed area such as a bookcase or in a cabinet. Any space open at the back (such as a dedicated equipment rack) is fine, however. Do not place the unit on an unstable surface or shelf. The unit may fall, causing serious injury to a child or adult as well as serious damage to the product. Do not place other equipment on top of the unit.

Due to stray magnetic fields, turntables or CRT TVs should not be located nearby due to possible interference.

Electronic audio components have a running in period of around a week (if used several hours per day). This will allow the new components to settle down and the sonic properties will improve over this time.

Power sources

The unit should be operated only from the type of power source indicated on the marking label. If you are not sure of the type of power-supply to your home, consult your product dealer or local power company.

This unit can be left in Standby mode when not in use and will draw <math><0.5W</math> in this state. To turn the unit off, switch off at the rear panel. If you do not intend to use this unit for a long period of time, unplug it from the mains socket.

Overloading

Do not overload wall outlets or extension cords as this can result in a risk of fire or electric shock. Overloaded AC outlets, extension cords, frayed power cords, damaged or cracked wire insulation and broken plugs are dangerous. They may result in a shock or fire hazard.

Be sure to insert each power cord securely. To prevent hum and noise, do not bundle the interconnect leads with the power cord or speaker leads.

Cleaning

To clean the unit, wipe its case with a dry, lint-free cloth. Do not use any cleaning fluids containing alcohol, ammonia or abrasives. Do not spray an aerosol at or near the unit.

Battery disposal

Batteries may contain substances harmful to the environment. Please dispose of any discharged batteries with due consideration and in accordance with local environmental/electronic recycling guidelines.

Loudspeakers

Before making any connections to loudspeakers, make sure all power is turned off and only use suitable cables.

Servicing

These units are not user serviceable. Never attempt to repair, disassemble or reconstruct the unit if there seems to be a problem. A serious electric shock could result if this precautionary measure is ignored. In the event of a problem or failure, please contact your dealer.

Limited warranty

Cambridge Audio warrants this product to be free from defects in materials and workmanship (subject to the terms set forth below). Cambridge Audio will repair or replace (at Cambridge Audio's option) this product or any defective parts in this product. Warranty periods may vary from country to country. If in doubt consult your dealer and ensure that you retain proof of purchase.

To obtain warranty service, please contact the Cambridge Audio authorised dealer from which you purchased this product. If your dealer is not equipped to perform the repair of your Cambridge Audio product, it can be returned by your dealer to Cambridge Audio or an authorised Cambridge Audio service agent. You will need to ship this product in either its original packaging or packaging affording an equal degree of protection.

Proof of purchase in the form of a bill of sale or receipted invoice, which is evidence that this product is within the warranty period, must be presented to obtain warranty service.

This Warranty is invalid if (a) the factory-applied serial number has been altered or removed from this product or (b) this product was not purchased from a Cambridge Audio authorised dealer. You may call Cambridge Audio or your local country Cambridge Audio distributor to confirm that you have an unaltered serial number and/or you purchased from a Cambridge Audio authorised dealer.

This Warranty does not cover cosmetic damage or damage due to acts of God, accident, misuse, abuse, negligence, commercial use, or modification of, or to any part of, the product. This Warranty does not cover damage due to improper operation, maintenance or installation, or attempted repair by anyone other than Cambridge Audio or a Cambridge Audio dealer, or authorised service agent which is authorised to do Cambridge Audio warranty work. Any unauthorised repairs will void this Warranty. This Warranty does not cover products sold AS IS or WITH ALL FAULTS.

REPAIRS OR REPLACEMENTS AS PROVIDED UNDER THIS WARRANTY ARE THE EXCLUSIVE REMEDY OF THE CONSUMER. CAMBRIDGE AUDIO SHALL NOT BE LIABLE FOR ANY INCIDENTAL OR CONSEQUENTIAL DAMAGES FOR BREACH OF ANY EXPRESS OR IMPLIED WARRANTY IN THIS PRODUCT. EXCEPT TO THE EXTENT PROHIBITED BY LAW, THIS WARRANTY IS EXCLUSIVE AND IN LIEU OF ALL OTHER EXPRESS AND IMPLIED WARRANTIES WHATSOEVER INCLUDING, BUT NOT LIMITED TO, THE WARRANTY OF MERCHANTABILITY AND FITNESS FOR A PRACTICAL PURPOSE.

Some countries and US states do not allow the exclusion or limitation of incidental or consequential damages or implied warranties so the above exclusions may not apply to you. This Warranty gives you specific legal rights, and you may have other statutory rights, which vary from state to state or country to country.

For any service, in or out of warranty, please contact your dealer.

Front panel controls

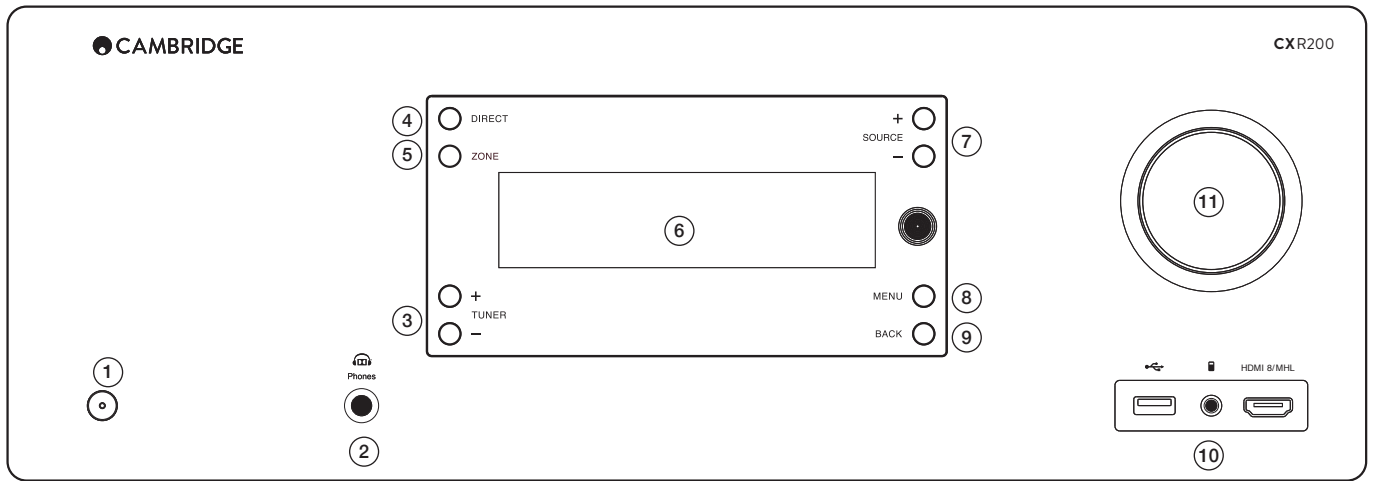

1. Standby/On

2. Phones

For suitable headphones – connection will mute the main zone speakers.

3. Tuning +/-

Used to tune FM/AM frequencies and presets for the built-in Tuner.

4. Direct

Disables any audio processing on the current source.

5. Zone (CXR200 only)

Press this button followed by Standby/On or Source +/- to change Zone 2. When illuminated, indicates that Zone 2 is On.

6. Display

Status window.

7. Source +/-

Also used for character entry. +/- button to move between character entry.

8. Menu

9. Back

In the Setup menu, press to return to the previous item.

10. USB / MP3 / HDMI/ MHL Inputs

USB - For playback of audio on USB Media from USB Flash-disks or USB hard-drives.

MP3 () – For connection to a portable audio device.

HDMI 8/MHL – For connection to a HDMI source or MHL compatible device.

11. Volume

Volume and 'select' button. Also used for character entry. Rotate to browse through the characters.

Rear panel connections

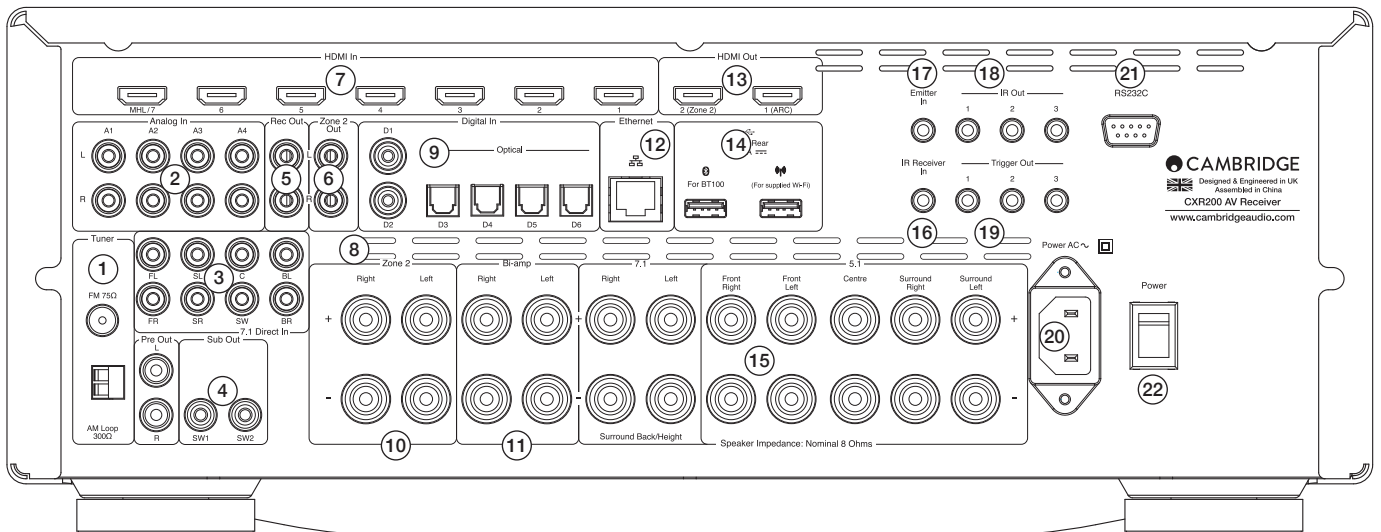

1. FM / AM aerials

2. Analogue inputs

(CXR120 3 inputs only)

3. 7.1 Direct in

4. Pre out / Sub out

5. Rec out

6. Zone 2 out (CXR200 only)

7. HDMI 2.0 compatible inputs

8. Vent grille

DO NOT OBSTRUCT!

9. Digital in

(CXR120 2 optical only)

10. Zone 2 speaker outputs (CXR200 only)

11. Bi-amp speaker terminals (CXR200 only)

12. Ethernet

13. HDMI 2.0 outputs

CXR120 – Outputs mirrored.

CXR200 – Output 2 can display a different source in Zone 2.

14. USB

For connection to the supplied wifi antenna or optional BT100 Bluetooth audio receiver.

15. Speaker terminals

16. IR receiver In

17. Emitter in

18. IR out

19. Trigger out

20. AC power socket

21. RS232C

Custom install control - a full protocol is available for the CXR on our website.

22. Power on/off

Main remote control

1. Backlight button

Illuminates the buttons.

2. Standby/On

3. Source buttons

Pressing the FM/AM button a second time toggles between FM and AM.

The TV button selects TV-ARC (Audio Return Channel).

The SM button selects the StreamMagic module.

4. Volume

5. Back

Press to return to the previous menu.

6. Home

Turns On and Off the on-screen setup menu.

7. Skip

Skips between tracks on the StreamMagic module.

8. Enter

9. Navigation

Press to navigate around the menus. Also used for character entry. ◀/▶ to move between character entry, ▲/▼ to browse through the characters.

10. Mute

11. Info

Displays current Source/Volume on screen.

12. Stereo modes

13. Surround modes

14. Stop/Play/Pause (StreamMagic)

Press to stop, play or pause streaming playback.

15. Direct

Disables any audio processing on the current source.

16. Dim

Adjusts the brightness of the front panel display.

17. Bass/Treble

18. Lip sync

19. Store presets

For FM/AM radio.

20. Stereo/Mono

For FM/AM radio.

21. Presets

Recalls stored presets.

22. Trigger

Toggle On and Off the Trigger outputs.

23. Zone 2

Press and hold then press Source button, Volume or Mute.

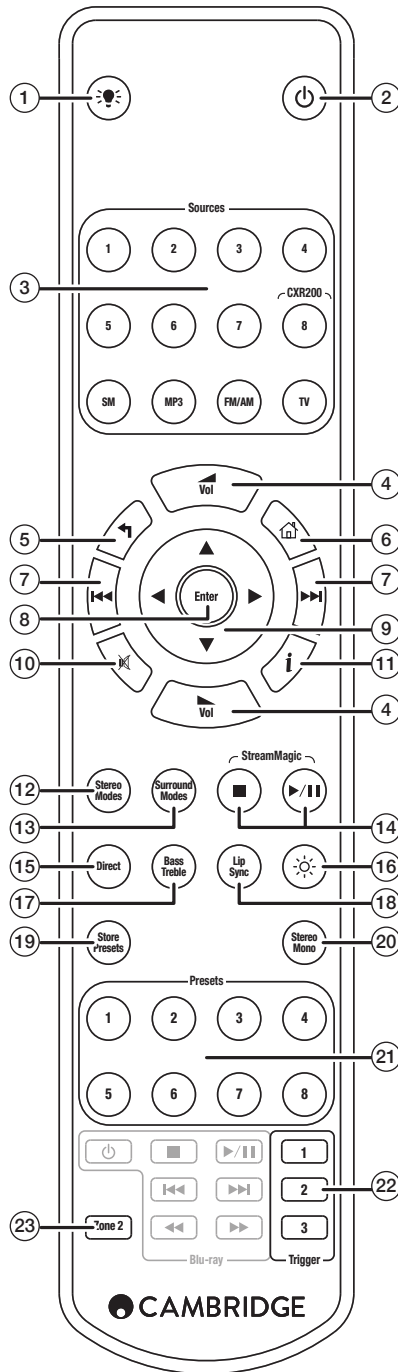

Loudspeaker connections

Switch the power off before making connections. Ensure that correct polarity is maintained.

Use 4mm plugs for direct insertion into the speaker terminals.

Surround back/height, Bi-amp and Zone 2 speaker connections can all be connected to speakers, but only one will be active. This can be set in the Speaker Configuration menu.

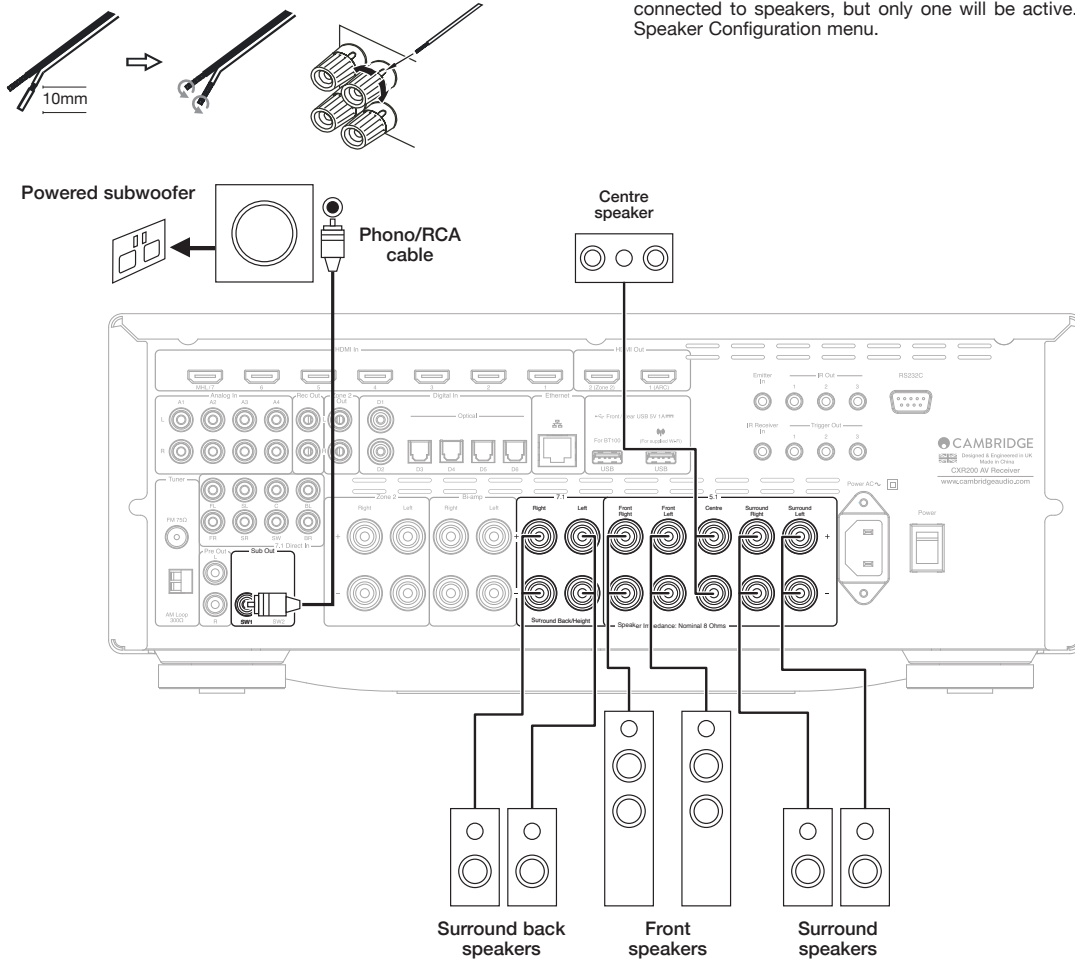

Analogue audio connections

Switch the power off before making connections.

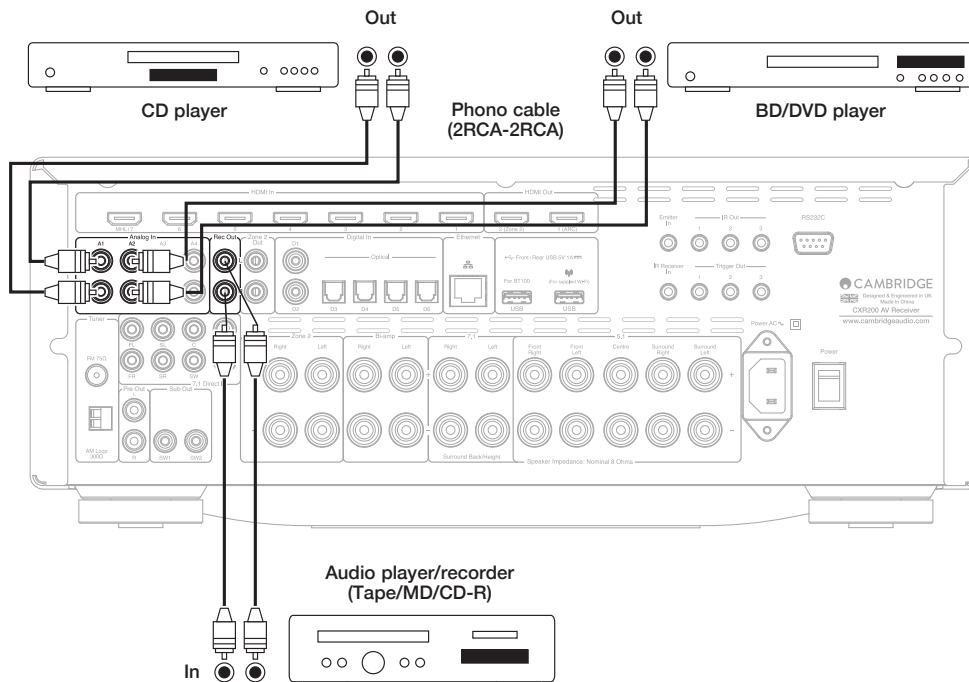

Digital audio connections

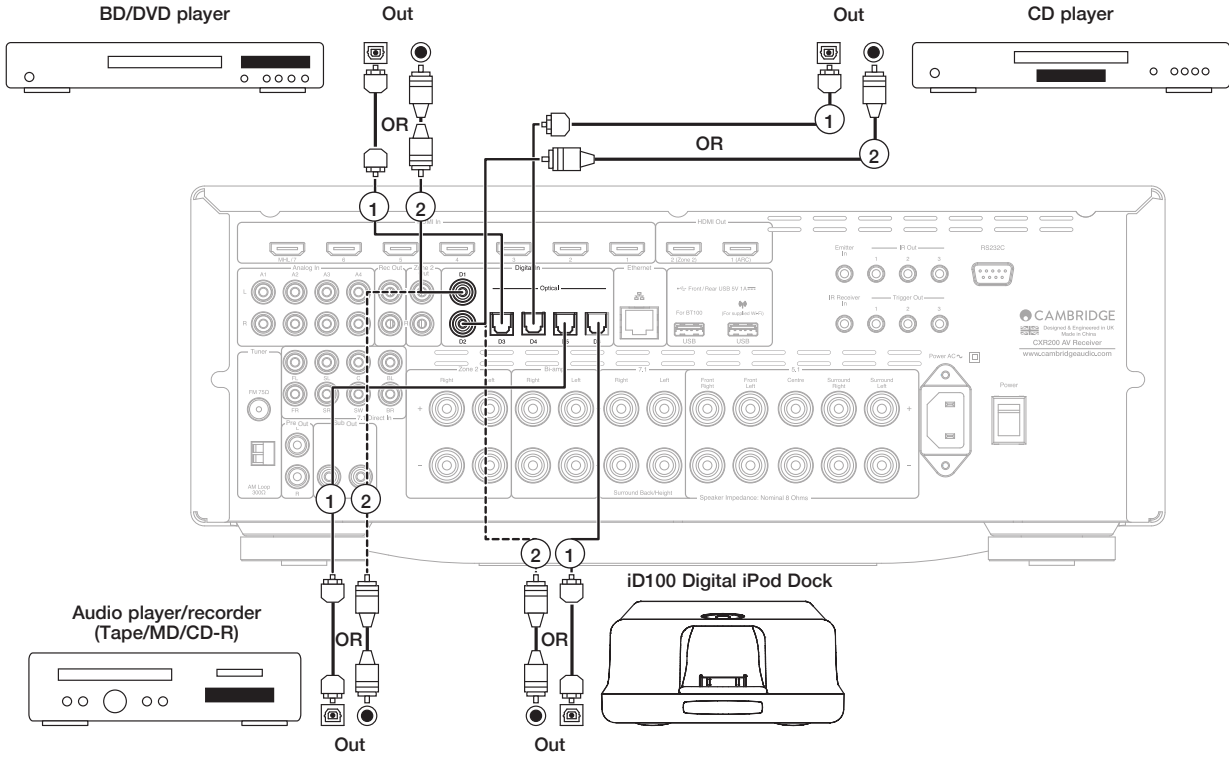

5.1/7.1 direct in

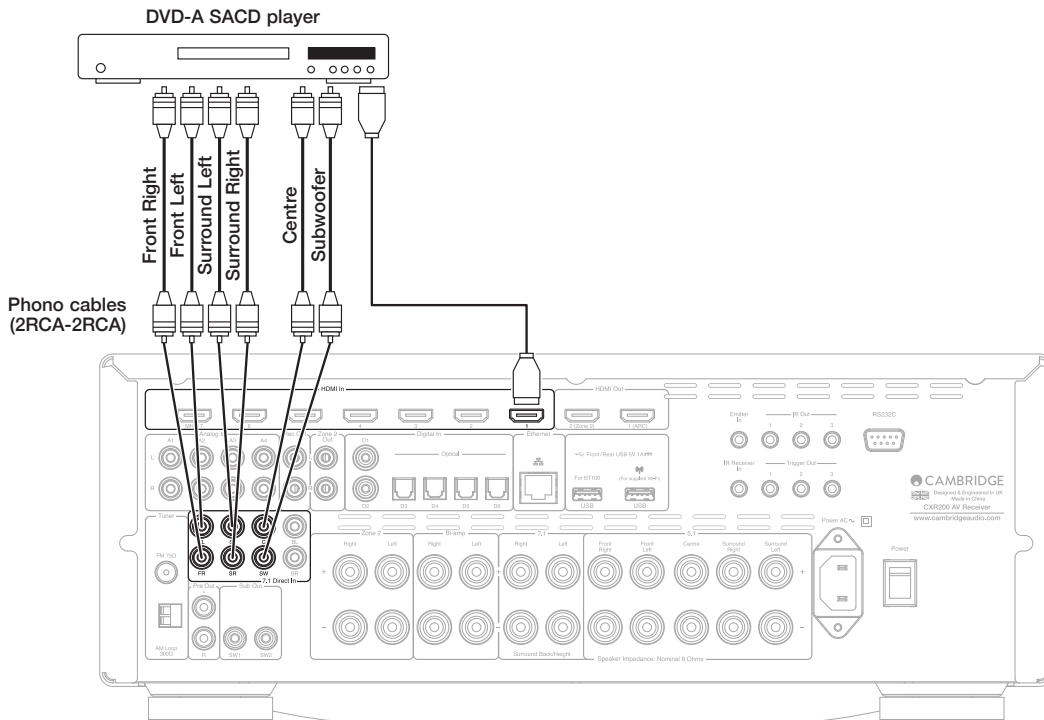

HDMI connections

The source resolution cannot be greater than that of the TV you are using - consult your HDMI source and TV manual and adjust accordingly.

Ensure that the HDMI output of your Blu-ray player has been set to 'Raw' to pass the latest high resolution audio formats to the CXR.

4K video resolution

The CXR supports 4K video resolution. Use a high speed HDMI cable when connecting 4K devices.

Note: 4K is not supported on the HDMI/MHL inputs.

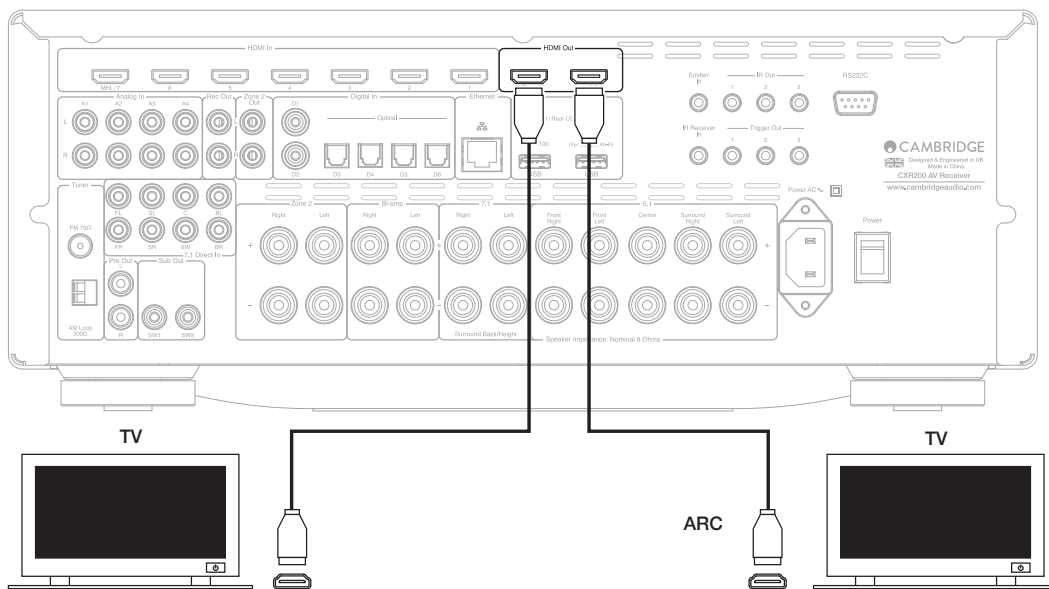
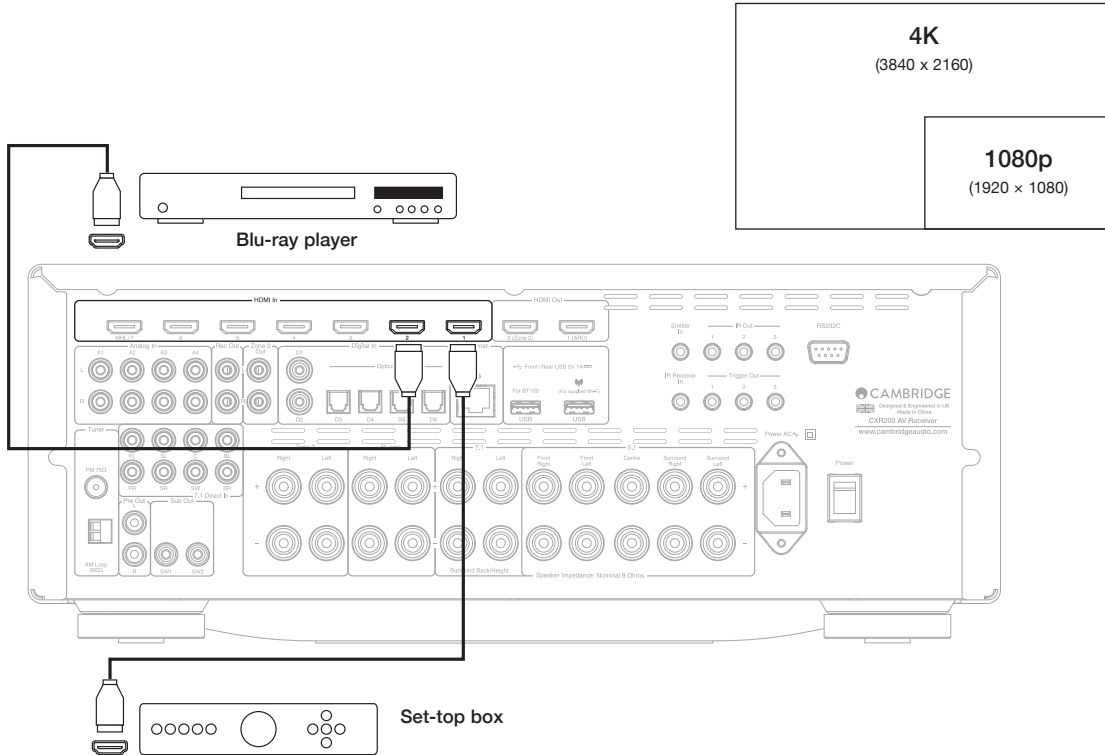

Aerial connections

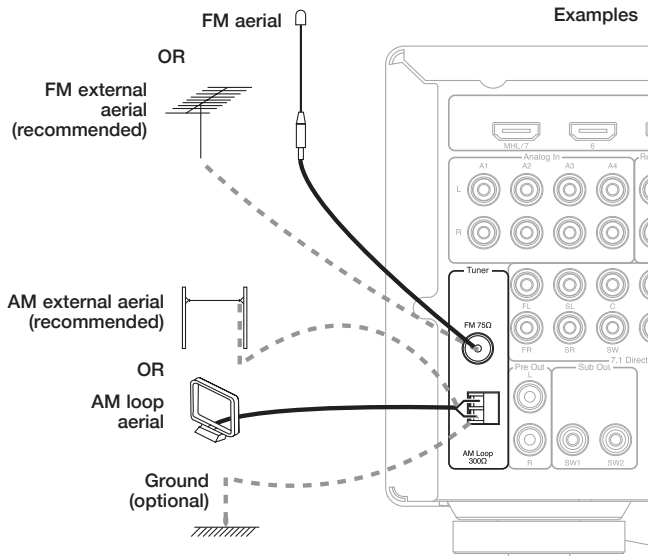

Using the tuner

Change the tuning mode to Preset, Manual or Scan via 'Input Setup > Mode' when the FM or AM tuner is selected.

Press the Tuning +/- button on the front panel (or the ▲ and ▼ buttons on the remote) to select station.

Frequency increments can be set for AM/FM depending on geographic location. 'General Settings > AM/FM Tuner Steps'.

Radio Data Systems (RDS)

Press the Info button on the remote to choose:

PS (Station Name) – Current station name will be shown.

PTY (Program Type) – Current program type will be shown.

RT (Radiotext) – Radiotext messages will be shown, if available.

Note: If no valid RDS data has been received the Info button will display the normal unit information.

Presets

1. Press and hold the Store Presets button on the remote for 5 seconds.
2. Use the Tuning +/- on the front panel or the navigation buttons to select a preset station number (1-30).
3. Press the Store Presets button on the remote to store the station.

StreamMagic

On the Connect App you can search for an Internet Radio station and then add it to a Preset memory location in the app.

Operating instructions

To activate the CXR, switch the Power switch on the rear panel to On then press the Standby/On button on the front panel.

Selecting the source

Select the source by using the Source +/- buttons on the front panel. After 4 to 5 seconds the CXR will select the new source, or it can be selected by pressing the volume knob. The source selection buttons on the remote control can also be used to directly select the source.

Selecting the desired listening mode

Select an appropriate mode for the source material/type you are listening to by pressing the Stereo or Surround Modes button on the remote.

Surround sound modes

The CXR supports several music and home-cinema listening modes. The output the CXR can provide depends both on the source signal present, the speaker setup selected and the decode mode selected.

DOLBY TRUE HD

Dolby's lossless audio technology developed primarily for high capacity Blu-ray discs/players. Dolby True HD delivers theoretically bit-for-bit sound identical to the studio master by the use of 100% lossless encoding. Previous formats such as Dolby Digital 5.1 or EX have used lossy encoding where some data (that is theoretically less audible) is always lost in the encoding process to reduce the storage capacity needed on the disc. This is a new format that supports up to eight (usually used as 7.1) full-range channels of 24-bit/96 kHz audio or two channels of 24/192 kHz via Blu-ray discs and is not backwards compatible with earlier schemes. The format can either be transmitted as a 'bitstream' to the CXR for internal decoding (recommended) or can be decoded by some Blu-ray players internally and sent to the CXR as multi-channel PCM. In both cases an HDMI connection is required to the CXR and a suitable Blu-ray player as Dolby True HD is only ever transmitted over HDMI.

DOLBY DIGITAL PLUS

An encoding scheme based on the original Dolby Digital CODEC, but with enhancements to improve coding efficiency and improved audio quality. Dolby Digital Plus supports 7.1 fully discrete channels compared to Dolby Digital 5.1 (or 6.1 in its EX variant where the 6th channel is matrix encoded). These Dolby Digital Plus bitstreams are not backward compatible with legacy Dolby Digital decoders but require an AV Receiver developed to decode them (such as the CXR) and an HDMI connection as Dolby Digital Plus is currently only transmitted over HDMI. It is however a requirement that any Dolby Digital Plus enabled Blu-ray player must also be able to transform the Dolby Digital Plus into a backwards compatible Dolby Digital 5.1 output for playback on legacy Dolby Digital systems. The CXR is however fully compatible with Dolby Digital Plus.

dts-hd Master Audio

A new lossless audio codec from DTS, rather than being incompatible with earlier versions, DTS-HD Master Audio is transmitted as an extension to a normal DTS bitstream. A second embedded stream is sent which contains the "difference" between the original studio master and the lossy compressed DTS, plus the two extra channels. DTS-HD Master Audio enabled devices (such as the CXR) are able to use this difference information to recreate a bit for bit lossless version of the original 7.1 data. Devices which do not support the Master Audio extension simply decode the original 5.1 DTS stream and ignore the Master Audio extension providing backwards compatibility.

dts-hd High Resolution Audio

Known also as DTS-HR an extension to the original DTS audio format. DTS-HD High Resolution Audio supports 7.1 fully discrete channels compared to DTS's 5.1 (or 6.1 in its DTS ES Matrix or DTS ES Discrete variants). As with DTS-HD Master Audio a second embedded stream is sent which contains the "difference" between the original studio master and the lossy compressed DTS, plus the two extra channels, however in this case the extra stream is also formed by lossy compression. Effectively this is a 7.1 version of DTS which can be decoded by devices (such as the CXR) which are able to decode DTS-HD High Resolution Audio. Devices which do not support the High Resolution extension simply decode the original 5.1 DTS stream and ignore the High Resolution extension providing backwards compatibility.

DOLBY DIGITAL

Known also as Dolby Digital (3/2) or Dolby Digital 5.1, provides (up to) 5.1 output from suitable encoded Dolby Digital material, with 5 main channels (Front Left, Front Right, Centre, Surround Left, Surround Right) and a Low Frequency Effects Channel for the subwoofer, all discretely encoded. Decoding Dolby Digital requires a Dolby Digital encoded DVD disc and a digital connection from the source equipment (Such as a DVD player) to the CXR.

Note: Dolby Digital and DTS formats can sometimes carry less channels than their maximum such as Dolby Digital (2/0) which means a Dolby Digital encoded signal which is actually only carrying a two channel stereo signal (other channels inactive).



Known also as DTS (3/2) or DTS 5.1, DTS provides (up to) 5.1 output from suitable encoded DTS material, with 5 main channels (Front Left, Front Right, Centre, Surround Left, Surround Right) and a Low Frequency Effects Channel for the subwoofer, all discretely encoded. Decoding DTS requires a suitably encoded DTS disc and a digital connection from the source equipment to the CXR.



Known also as Dolby Digital (3/3) or Dolby Digital 6.1, an enhanced form of Dolby Digital. On top of the discretely encoded 5.1 channels Dolby Digital EX provides an extra 6th channel (Surround Back, giving 6.1) matrix encoded into the rear surrounds for greater image depth and more solid sound localisation behind the listener. Dolby Digital EX requires a Dolby Digital EX encoded disc. Dolby Digital EX is backwards compatible with Dolby Digital 5.1 decoding. If Dolby Digital EX is decoded as normal Dolby Digital the Surround Back signal will be present in both Left and Right Rear Surrounds (forming a phantom rear centre). It can also be decoded as 7.1 by sending the Surround Back decode to both the Surround Back Left and Right speakers (forming two mono Back Surrounds).



Known also as DTS (3/3) Matrix, an enhanced form of DTS. On top of the discretely encoded 5.1 channels DTS ES also provides an extra 6th channel (Surround Back giving 6.1), matrix encoded into the rear surrounds for greater image depth and more solid sound localisation behind the listener. DTS ES requires a DTS ES encoded disc. DTS ES material is backwards compatible with DTS 5.1 decoding. If DTS ES is decoded as normal DTS the Surround Back signal will be present in both Left and Right Rear Surrounds (forming a phantom rear centre). It can also be decoded as 7.1 by sending the Surround Back decode to the both the Surround Back Left and Right speakers (forming two mono Back Surrounds).



Another enhanced form of DTS, also known as DTS (3/3) Discrete or DTS ES Discrete 6.1. DTS ES Discrete also provides an extra channel (Surround Back) for greater image depth and more solid sound localisation behind the listener, however in this case extra data is included in the bitstream so that all channels are discretely encoded. The Surround Back has greater separation from the other channels than is possible with matrix encoded technologies. DTS-ES Discrete requires a DTS-ES Discrete encoded disc.

DTS ES Discrete is backwards compatible with both DTS 5.1 and DTS ES Matrix 6.1 decoding. If DTS ES Discrete is decoded as normal DTS the Surround Back signal will be present in both Left and Right Rear Surrounds (forming a phantom rear centre). If DTS ES Discrete is decoded with DTS ES Matrix the Surround Back signal will be decoded separately (i.e. as 6.1) but by a matrix process, which will give the same channel separation as if the source disc were actually DTS ES Matrix (but not as good as DTS EX Discrete).

It can also be decoded as 7.1 by sending the Surround Back decode to both the Surround Back Left and Right speakers (forming two mono Back Surrounds).



The replacement for the original Dolby Pro Logic, Dolby Pro Logic II is a technology where 5 channels (Front Left, Front Right, Centre, Surround Left, Surround Right) are encoded into a Stereo mix by an analogue matrix process. Dolby Pro Logic II material can be played back by normal Stereo equipment (as Stereo) or decoded into 5 channel surround-sound.

Dolby Pro Logic II is compatible with the earlier 4 channel (Left, Centre, Right and mono Surround) Dolby Pro Logic system (which was the decoding counterpart to Dolby Surround encoding) as used widely on Video tapes, TV broadcasts and earlier films.

Note: Dolby Pro Logic does not include a Low Frequency Effects channel for the Subwoofer, but the CXR can create a Subwoofer output (for 5.1) via Bass management. Refer to the 'Speaker Setup' section of this manual.



A newer version of Dolby Pro Logic II which is able to recreate 7 discrete surround sound channels from suitable encoded stereo source material. Dolby Pro Logic Ix also has modes for post processing either Stereo material or 5.1 material into 7 channels whether or not it has been Dolby Pro Logic Ix encoded. When 5.1 decoding is required, Dolby Pro Logic II decoding will always be used by the CXR in place of Dolby Pro Logic Ix as Ix only works for 7 channel output.

Note: Dolby Pro Logic Ix does not include a Low Frequency Effects channel for the Subwoofer, but the CXR can create a Subwoofer output (for 7.1) via Bass management. Refer to the 'Speaker Setup' section of this manual.



A new Dolby matrix technology that delivers additional height channels positioned above the front left and right speakers. Dolby Pro Logic IIZ identifies spatial cues that occur naturally in most content plus ambient sound and amorphous effects such as rain or wind and directs them to additional front height speakers.

Movie and game producers can also mix specific additional height channels into a 2ch, 5.1 or 7.1 soundtrack, which Dolby Pro Logic IIZ will then decode as a post process.

If it is desired to use Dolby Pro Logic IIZ, you should set the CXR to 5.1 + Height mode, connect two speakers to the SBL and SBR outputs and physically position them above your left and right front speakers, then select Dolby Pro Logic IIZ post processing. See later section.



A DTS technology which is able to recreate 6 channel (Left Front, Right Front, Centre, Left Surround, Right Surround, Surround Back) surround sound from suitable analogue matrix encoded stereo source material. DTS Neo:6 material can be played back by normal Stereo equipment (as Stereo) or decoded into 7.1 by sending the Surround Back decode to the both the Surround Back Left and Right speakers (forming two mono Back Surrounds).

Note: Neo:6 does not include a Low Frequency Effects channel for the Subwoofer, but the CXR can create a Subwoofer output via Bass management. Refer to the 'Speaker Setup' section of this manual.



A DTS technology that provides 5.1 channels of 96kHz / 24bit audio (along with video if required) on DVD-Video and DVD-Audio (video zone) discs (when suitably encoded in DTS 96/24). DVD players which allow 'DTS digital out' pass the DTS 96/24 bitstream over S/P DIF or HDMI for decoding in the CXR.

DSP modes

Stereo/Stereo + Sub

These modes allow you to choose between conventional stereo left and right speakers or stereo speakers with subwoofer.

Direct

Analogue and digital inputs will bypass any DSP, Bass/Treble controls and multichannel post processing.

All channels

A stereo input will be mapped to all speakers, with left speakers receiving left stereo and right speakers receiving right stereo. The center and sub will be sent a mono signal.

Setup menu

Speaker setup

Refer to the following diagrams for typical examples of loudspeaker setups.

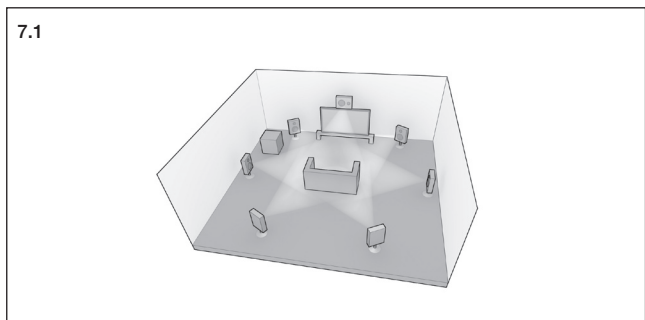
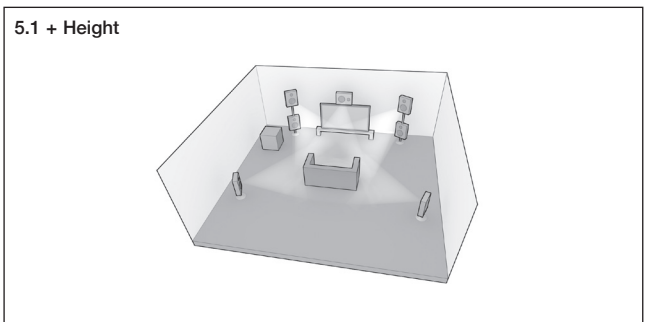
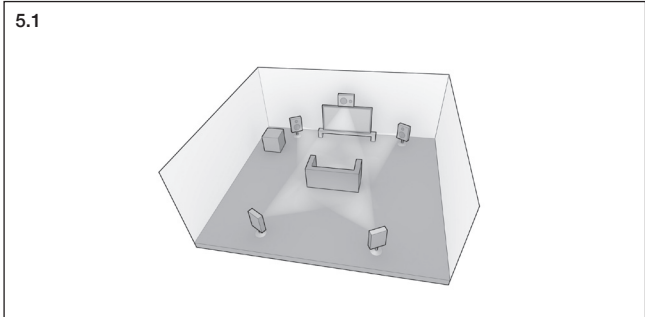

Speaker configuration

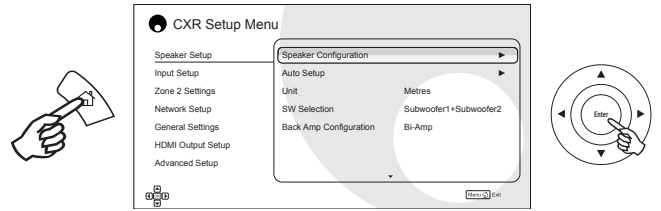

First select the number of subwoofers you have connected 'SW Selection' and if you have a 7.1 system choose 'Surround Back' for the Back Amp Configuration. If you have chosen to use height speakers, choose '5.1+Height'.

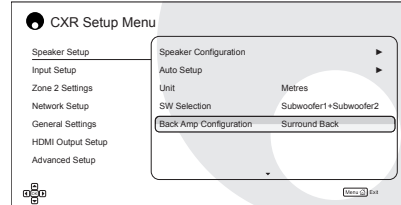
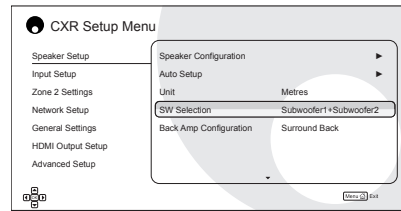

Auto setup

Auto setup will check if your speakers are available, connected correctly, their size and set crossover and distance.

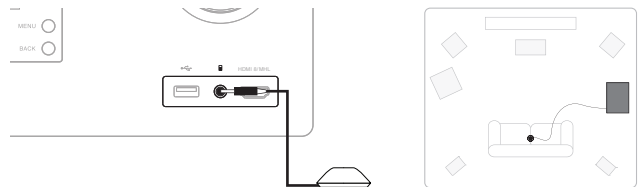

Select 'Run Auto Setup'.

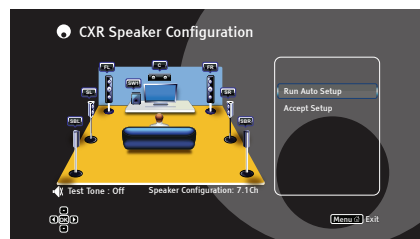

Select your speaker setup.

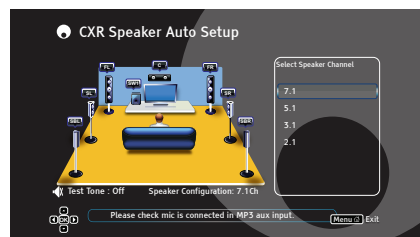

Once finished press the Enter button on the remote to accept the setup.

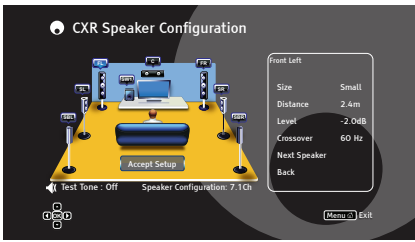

If an error occurred during the process, the CXR will indicate which speaker(s) you will need to check before restarting the process.

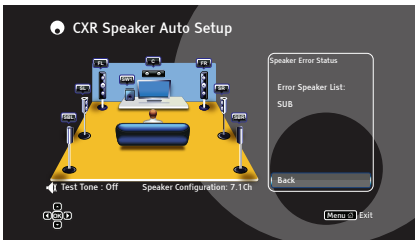

Level

Highlight 'Test Tone' and press Enter. Use the navigation button on the remote to move from speaker to speaker and adjust the level until all are at the same volume using either the Front Left or Right as a reference.

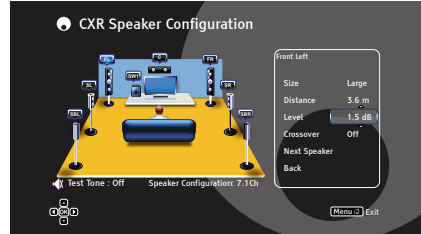

Crossover (for small speakers)

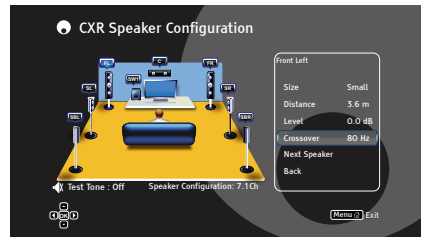

Manual setup

Size

Select the speaker to be setup and choose from small, large or none.

Large = Floorstanders or large stand-mounted speakers.

Small = Small or satellite speakers (sub must be used).

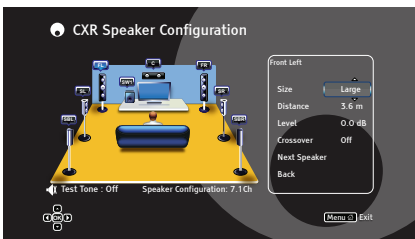

Distance

Measure the distance from your listening position to the speaker concerned and enter the distance. CXR will compensate for the differing distances to each speaker in your system.

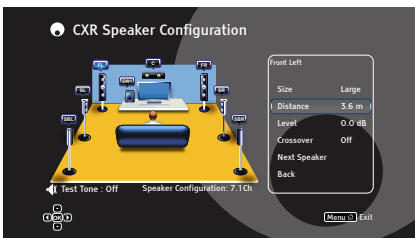

Unit

Set to Feet or Metres.

Input setup

Source input

Input source selection.

Input name

Use the ▲▼◀▶ navigation buttons on the remote or +/- input buttons on the front panel to select characters and customise the name.

Video input

You can assign a HDMI video input for StreamMagic /Connect, MP3, FM and AM sources only.

Video scaling

In Processed mode CXR will upscale 1080p video to 4K. In Passthrough mode the output video format will be the same as the input.

Audio input

Select either analogue, digital, HDMI, 7.1ch direct in or None.

The Audio Input for SM/Connect, MP3, FM and AM cannot be changed.

Analog audio process

Choose No to bypass DSP.

Bass

Adjusts bass.

Treble

Adjusts Treble.

Dolby volume

Dolby volume maintains a consistent volume across all content, programs and input sources.

Dolby volume leveler

Can be set from 1-9 or off: experiment to find the preferred setting

Dolby calibration offset

Used to trim differences in input level between sources.

Input setup cont.

Stereo processing

Choose preferred stereo processing mode for the current source.

Multichannel processing

Choose preferred multichannel processing mode for the current source.

Lip sync

Adjust the audio delay if necessary to synchronise to video for the current source.

Zone 2 (CXR200 only)

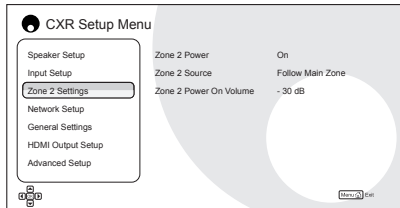

You can select sources independent from Main in Zone 2 or set to 'Follow Main Zone'.

HDMI 2 will output the audio as formatted by the chosen source, either stereo or multichannel unless set to 'Follow Main Zone' in which case a stereo downmix signal will be output.

Zone 2 line level and speaker outputs

To get audio in Zone 2 from a HDMI source you must select 'Follow Main' or select the same source as in the Main zone. If a different source is selected for Zone 2, then the zone 2 source must have a stereo audio input selected.

Zone 2 speaker outputs

In the menu 'Speaker Setup > Back Amp Configuration' select 'Zone 2'.

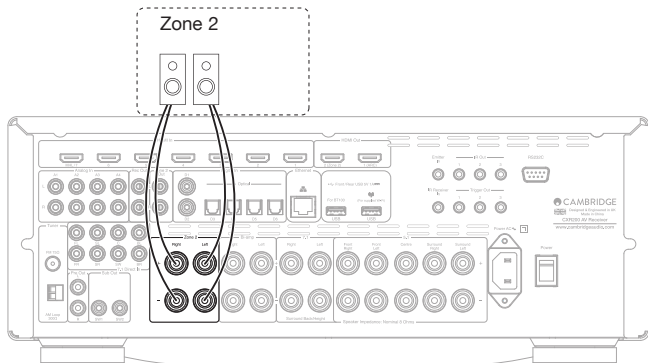

Using Zone 2 with an external amplifier

The Zone 2 line level outputs can be connected to an amplifier for use in zone 2.

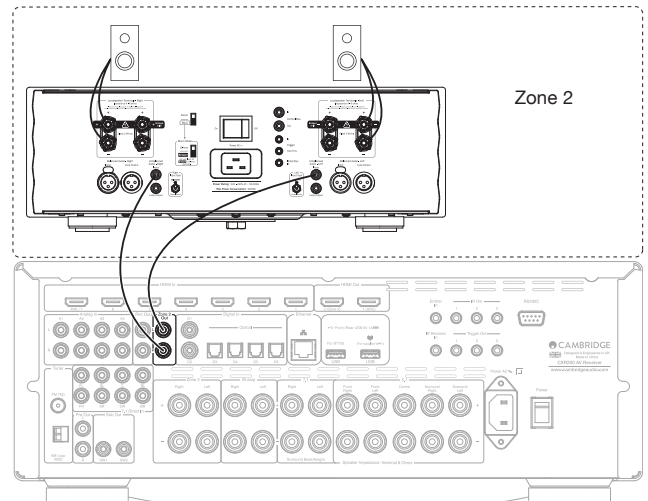

Controlling zone 2

You can use the main remote handset, the buttons on the front of the unit itself or the Cambridge 'Connect' App to control Volume, source and mute.

From the remote press and hold the Zone 2 button followed by the feature you require.

Zone 2 power

Enables the Zone 2 function.

Zone 2 source

Select the video/audio source that will be sent to Zone 2.

Zone 2 power on volume

Set the desired maximum volume level when powering on Zone 2.

Network setup

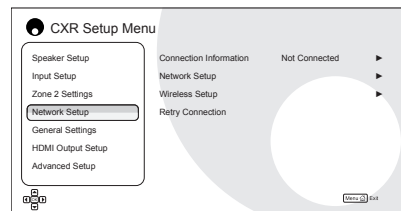

To use CXR for Internet Radio/Audio Streaming you need:

- A broadband internet connection
- A wifi or wired network connection.

Use a wired connection for seamless playback of high resolution 24/176 and 24/192 files.

Connecting to a wired network

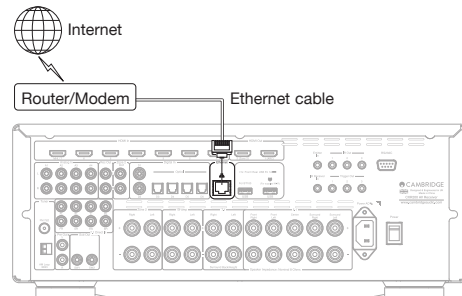

Connect a network cable (Category 5/5E or better, straight through Ethernet cable) between the CXR and your router.

Network setup

For advanced users wanting to use a static IP. Only select static IP if you know exactly what you are doing!

Wireless setup

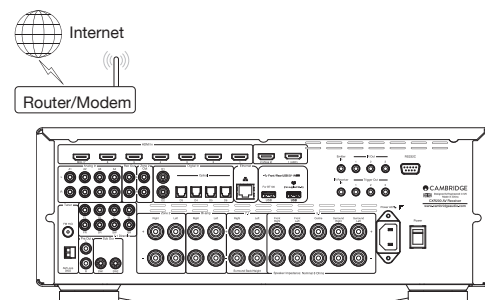

Connect the supplied wireless antenna to the correct USB input on the rear of CXR – it will need to be in range of your wireless router.

Select 'Scan for Networks', select your wifi network and then enter your password.

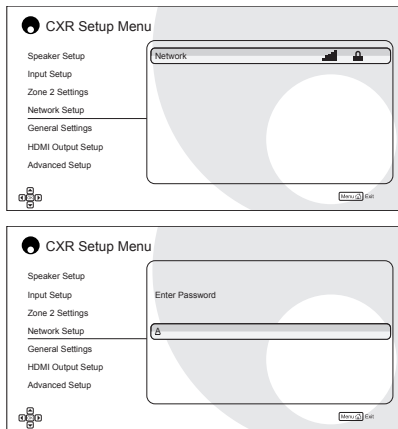

Retry connection

Retry if the connection failed.

General settings

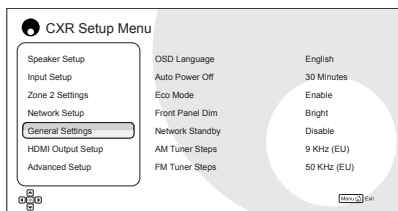

OSD language

Choose language for on screen display.

Auto power off

If nothing is playing CXR will turn off after 30mins. You can change this to 1 Hour, 4 Hours, 8 Hours and Off.

ECO mode

0.5W standby mode where Standby HDMI Bypass and Network Standby cannot be used.

Front panel dim

Change the brightness of the CXR display.

Network standby

Enable: The network connection is always on and CXR can be powered on from the Connect App.

AM tuner steps

Set AM tuner steps for EU or USA.

FM tuner steps

Set FM tuner steps for EU or USA.

HDMI output setup

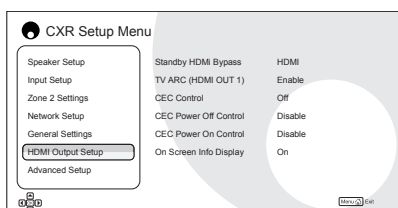

Standby HDMI bypass

Allows one HDMI source to be sent to your TV when the CXR is in standby mode, for example if you want to use your TV's speakers.

TV ARC (HDMI out 1)

ARC allows a TV to send audio back down its incoming HDMI so that you can play back the audio from a TV source whilst you watch its picture.

CEC control

Turn on to enable CEC control features.

CEC power off control

Allows the CXR to be switched off into standby by the TV.

CEC power on control

Allows the CXR to be switched on from standby by the TV.

On screen info display

When enabled, the input is changed or the info button on the remote control is pressed the Source name, Audio signal type and volume setting will be displayed on your screen.

Advanced setup

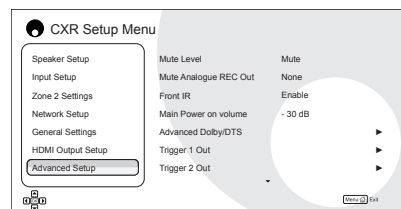

Mute level

Select complete Mute, -10dB below current level or -30dB below current level.

Mute analogue REC out

Use this to prevent the analogue input your recording device is connected to being looped back to its input.

Front IR

If disabled, re-enable using the volume control to navigate and select.

Main power on volume

Sets maximum volume level when powering the CXR on.

Advanced Dolby/DTS

Panorama mode – A Dolby Pro Logic II/IIx mode that extends the front Stereo sound to the surround speakers.

Centre Width – Adjusts from 100% Center speaker (Setting 0) to center speaker signal being sent completely to left and right main speakers (Phantom Centre, Setting 7).

Dimension – Adjusts the soundfield to shift gradually from the front of the room to the back.

Dolby DRC (Dynamic Range Control)

Limits the difference in level between loud and quiet passages.

Dolby D EX modes

Decoding of Dolby EX encoded tracks for surround speakers.

Height gain

Sets the gain of height speakers.

HDMI output setup cont.

DTS-HD speaker re-map

When playing back a DTS-HD track the CXR can electronically reposition your speakers to match the setup used in the original recording studio. This is done automatically in most cases, but for 7.1 setups you will need to choose either option 1 or 5 – whichever most closely resembles your actual speaker layout.

Configuration 1 – 7.1 channel: L, C, R, LFE, Ls, Rs, Lsr, Rsr

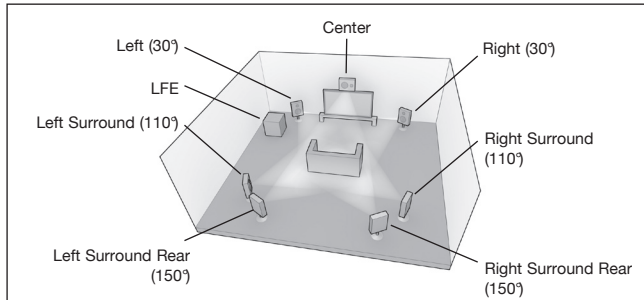

Configuration 5 – 7.1 channel: L, C, R, LFE, Lss, Rss, Lsr, Rsr

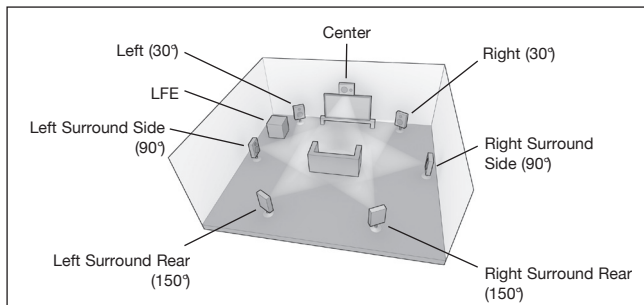

Trigger outputs

The outputs are 0V for Off and 12V for On at up to 100mA. The connections are 3.5mm mono mini-jacks, with the tip as the output, ring as ground.

The options are:

Manual Select: Trigger output is toggled On/Off by the matching Trigger button on the remote control.

Follow Standby: The trigger output will follow the On/Off status of the unit.

Sources: – The trigger output is linked to a specific source.

SW version

All 4 software version numbers need to be stated when contacting Cambridge Audio customer support.

Update via USB

The CXR software can be updated from the front panel USB socket, which would normally only be required by a service department or where a network is not available. Normally user updates will be via a network connection.

Save current settings

Saves settings to internal memory. If the current settings have not been saved, it is advisable to save the current settings before a software update is performed.

Load saved settings

Loads the stored settings.

Factory reset

After a factory reset any saved settings can be restored if desired.

Network software update

The CXR can be updated via the StreamMagic module connected to the internet. Updates of the StreamMagic module itself can only be started from the Cambridge Connect app or the Web administration interface.

Note: A full update can take over 45 minutes to complete.

Web administration interface

This interface allows the user to:

- Customise the name displayed in the Players list in the Cambridge Connect app and in the Spotify Connect device list.
- Setup the wireless network connection.
- Upgrade the CXR's firmware.

Wired connection

Connect the CXR to a wired network and find the IP address in the 'CXR Setup Menu'.

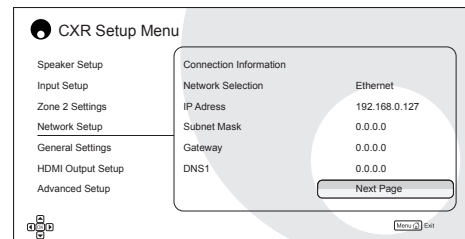

Use a web browser on the same network to connect to the CXR IP address, eg <http://192.168.0.127/>

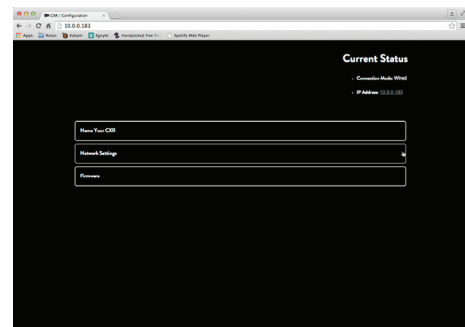

Wireless connection

Plug in the supplied wireless antenna to the USB socket on the rear of the CXR.

Go to your computer/tablet and click on the Wi-Fi/network logo and select CXR.

Use a web browser on your device to connect to <http://10.10.10.10/>

Cambridge Audio is a brand of Audio Partnership Plc
Registered Office: Gallery Court, Hankey Place
London SE1 4BB, United Kingdom
Registered in England No. 2953313

www.cambridgeaudio.com

